

Pico Scene Keypads

The Pico wireless keypad is a flexible and easy to use device that allows the user to adjust multiple lights and shades to different levels at the touch of a button. This battery-operated keypad requires no external power or communication wiring.

Features

- Provides easy access to scene control in the following Lutron systems:
 - Caséta Wireless
 - RA2 Select
 - RadioRA 2
 - HomeWorks QS
- Keypads available in a variety of button marking options.
- Keypads available in Gloss and select Satin Colors finishes.
- Easy reconfiguration for use as:
 - Wall-mount keypad (with or without faceplate; faceplate adapter kit sold separately)
 - Table-top keypad (table-top pedestal sold separately)
- Utilizes Lutron reliable Clear Connect RF technology.
- Battery-powered. Requires no wiring.
- 10 year battery life¹ (one CR2032 battery included).
- Can provide control of lighting devices, shades, or drapes within a range of 30 ft (9 m) through walls and 60 ft (18 m) line-of-sight.
- Each button is individually programmable using the system's app or programming software.

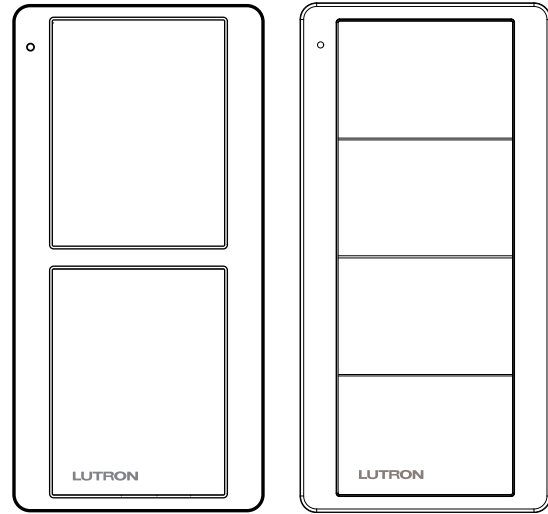

Pico Scene Keypads

¹ Based on a 1 year shelf life, an average of 10 button presses per day, and an ambient temperature of 86 °F (30 °C). Actual life may vary based on usage and environmental conditions.

Job Name:	Model Numbers:
Job Number:	

Specifications

Regulatory Approvals

- Lutron Quality Systems registered to ISO 9001.
- FCC Certified (U.S.A.)
- IC Certified (Canada)
- COFETEL Certified (Mexico)
- SUTEL Certified (Costa Rica)
- Anatel Certified (Brazil)

Power

- Operating Voltage 3 V==
- (1) CR2032 battery (included)

System Communication and Capacity

- Communicates using Radio Frequency (RF) at 431 MHz to 437 MHz.
- Thousands of system addresses prevent interference between systems.
- Can be assigned to control lighting devices, shades, or drapes within a range of 30 ft (9 m) through walls and 60 ft (18 m) line-of-sight.

Mounting Considerations

- All RF devices must be mounted on non-conductive materials to ensure proper performance.
- Mounting of any RF devices on or in close proximity to a metal surface will drastically reduce the effective range of radio signal transmission or reception.
- If you wish to mount your Pico wireless keypad to a metal surface, the PICO-MOUNT-1-XX-CPN6774 will be required in order to maintain proper RF performance. For availability, please contact your local Lutron sales office.
- Wall mounting adhesive included. See **Mounting Options** section for other options.

Environment

- Ambient operating temperature: 32 °F to 140 °F (0 °C to 60 °C)
- Maximum 90% non-condensing relative humidity
- Indoor use only

Warranty

- 1 Year Limited Warranty. For additional Warranty information, please visit www.lutron.com/TechnicalDocumentLibrary/369-119_Wallbox_Warranty.pdf

Job Name: Job Number:	Model Numbers:
--	-----------------------

Dimensions

Measurements shown as: in (mm)

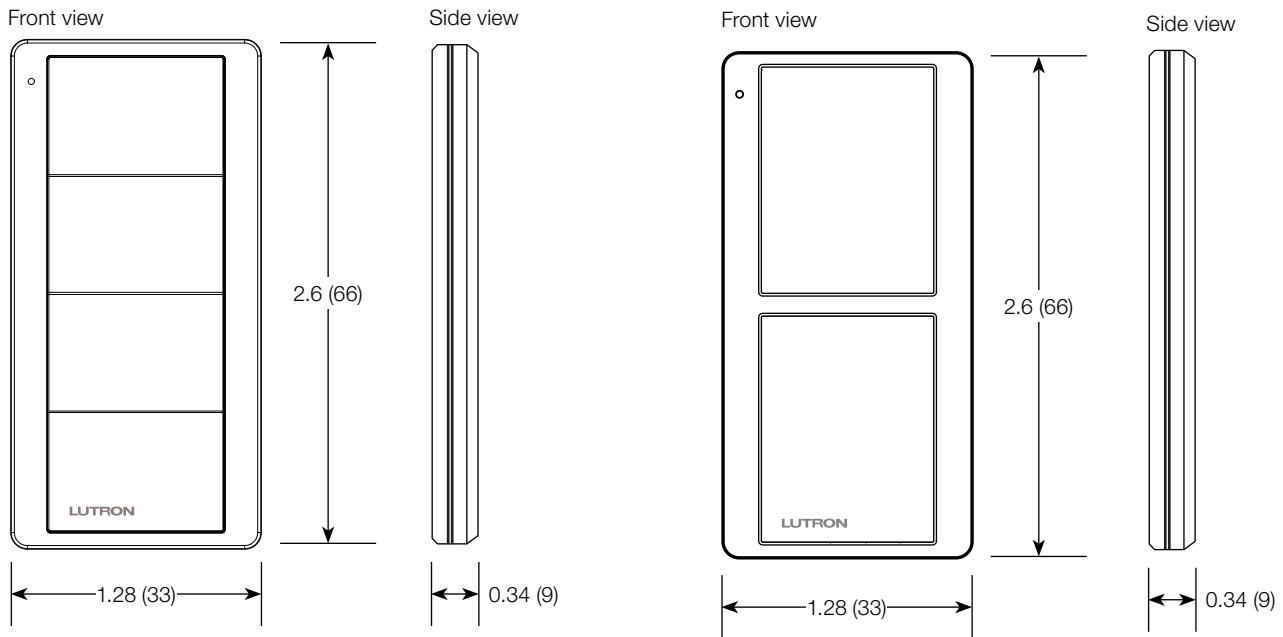

Operation

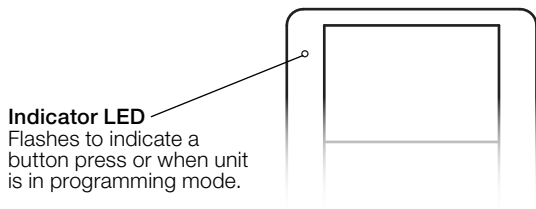

Scene Controls (Default settings: 100%, 66%, 33%, 0)

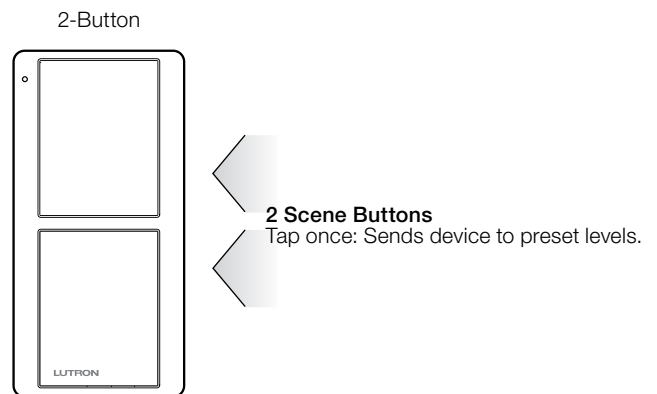
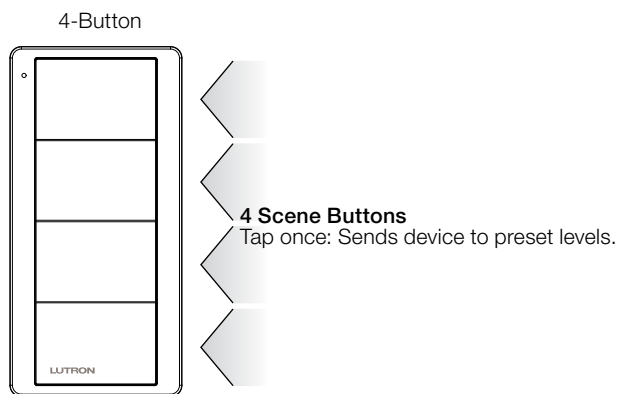

Job Name:	Model Numbers:
Job Number:	

Model Number

Standard Icon Models

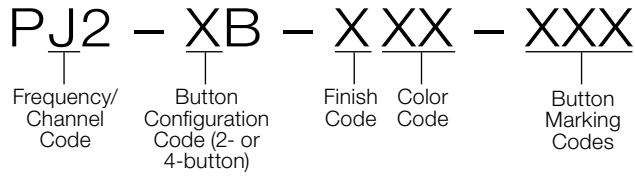

Frequency/Channel Code

J: 431.0–437.0 MHz

Finish Codes

Finish	Code
Gloss	G
Textured	T

Color Codes: Gloss

Color	Finish Code	Color Code
White	G	WH
Black	G	BL
Ivory	G	IV
Light Almond	G	LA

Color Codes: Satin Colors

Color	Finish Code	Color Code
Snow	T	SW
Biscuit	T	BI
Midnight*	T	MN

* Coming soon

Button Marking Codes

Scene Controls

4-Button

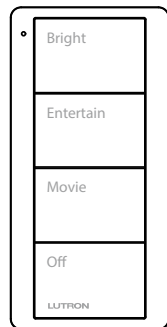

Family Room - P01

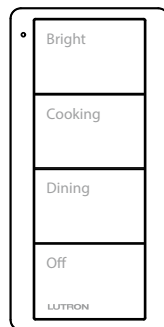

Kitchen - P02

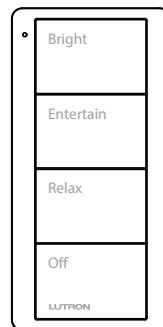

Any Room - P03

2-Button

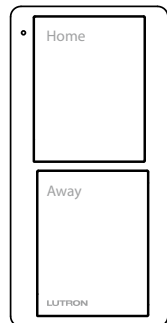

Entry - P01

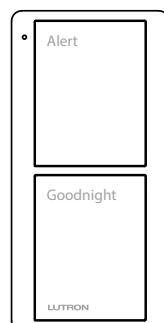

Bedside - P02

Job Name:	Model Numbers:
Job Number:	

Pico Pedestal Model Number

Pedestals sold separately.

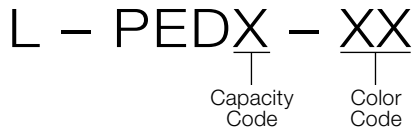

Capacity Codes

Capacity	Code
Single	1
Double	2
Triple	3

Color Codes

Available in gloss finish only.

Color	Code
White	WH
Black	BL

Dimensions

Measurements shown as: in (mm)

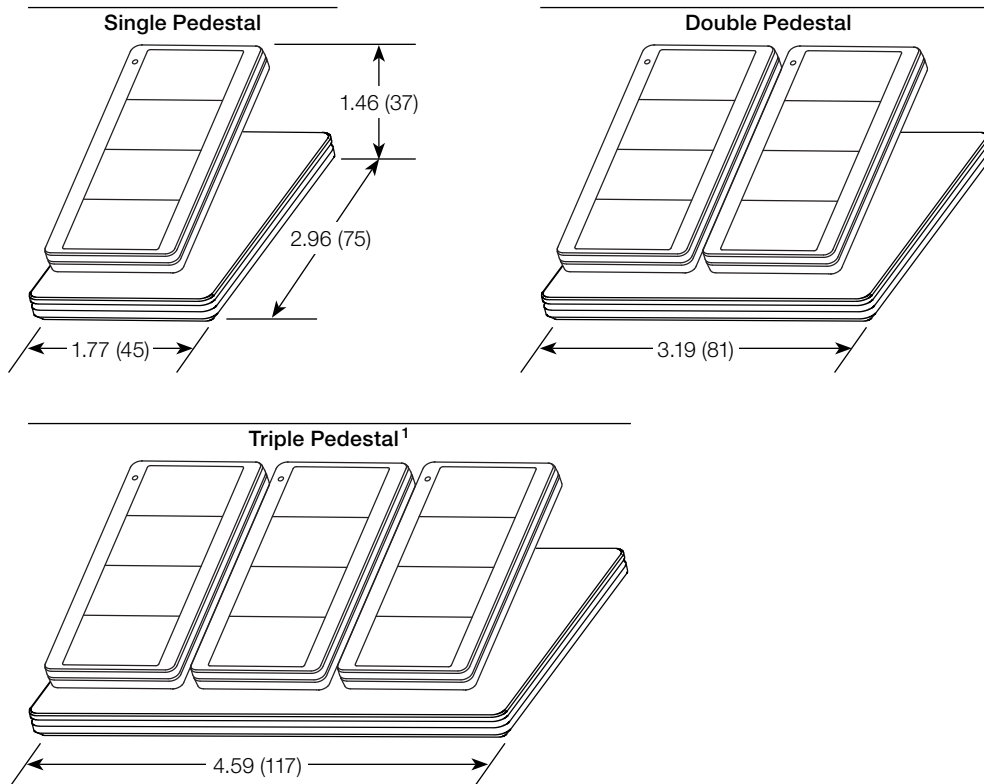

¹ For Triple Pedestals contact your local Lutron sales office or visit us at www.lutron.com

Job Name: Job Number:	Model Numbers:
--	-----------------------

Mounting Options

Standalone Mounting: Adhesive-Mount

Included with Pico wireless keypad



Standalone Mounting: Screw-Mount

Model PICO-SM-KIT
(sold separately)

Kit includes special screws to be used for more permanent mounting and/or for non-smooth surfaces.



Wallbox Adapter

Model PICO-WBX-ADAPT
(sold separately)

Wallplate adapter/wallplate sold separately.

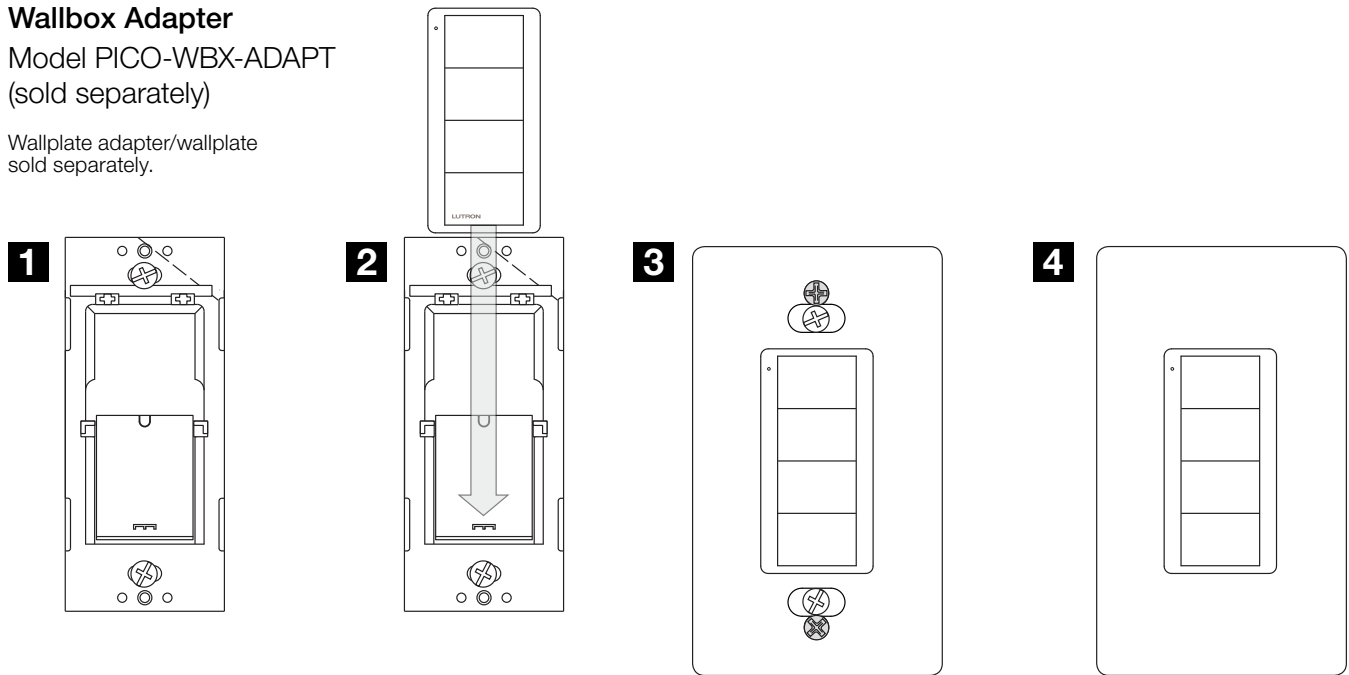

<p>Job Name:</p> <p>Job Number:</p>	<p>Model Numbers:</p>
--	-----------------------

Mounting Options (continued)

Metal Surface Mounting

Model:
PICO-MOUNT-1-XX-CPN6774
(sold separately)

Contact your local Lutron sales office.

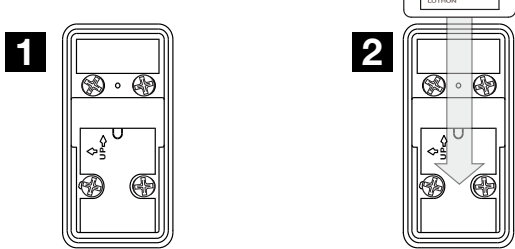

Mounting to a Car Visor

Model PICO-CARVISOR-CL (sold separately)

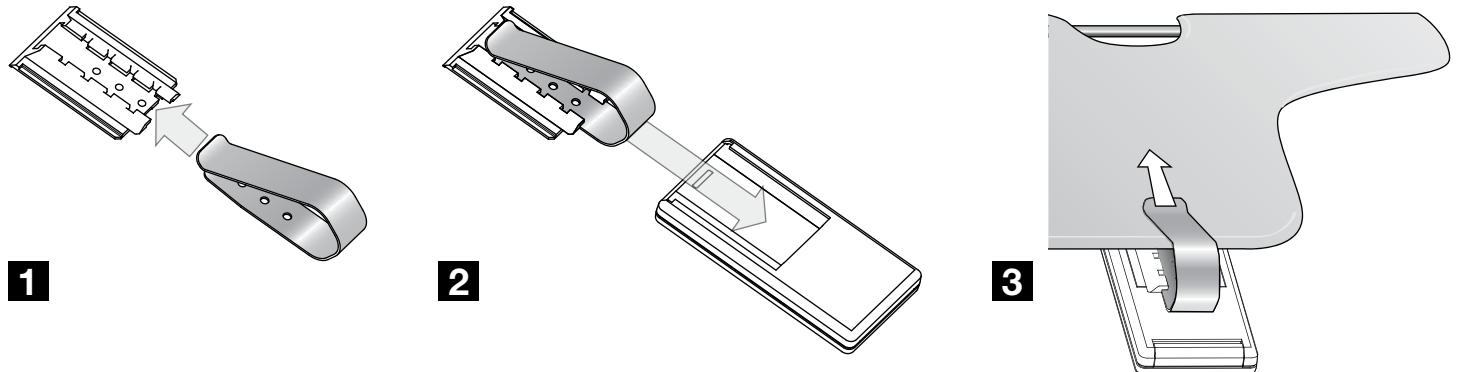

Lutron, Lutron, Pico, RadioRA, Clear Connect, HomeWorks, Caséta, and Satin Colors are trademarks of Lutron Electronics Co., Inc. registered in the U.S. and other countries.

RadioRA2 and RA2 Select are trademarks of Lutron Electronics Co., Inc.

LUTRON SPECIFICATION SUBMITTAL

Page

Job Name:	Model Numbers:
Job Number:	