

A Global Leader in Innovative...

Wire & Cable Management • Cable Protection Systems
Power Connection & Control • Safety Technology

Thomas & Betts

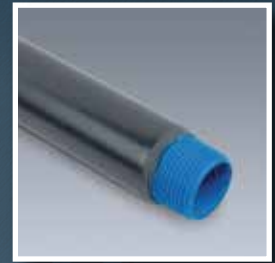

***Ocal[®] Corrosion-Resistant
Conduit Systems***

www.tnb.com

Ocal® PVC-coated conduit and fittings and other T&B products — better by design to stand up to your most demanding corrosive environments.

When you're dealing with the world's most corrosive environments, just any PVC-coated conduit won't do.

- Ocal® has industry leading thread protection through a hot-dipped galvanizing process, and industry leading UL® Listed Type 4X PVC-coated conduit bodies.
- Ocal® offers a full undisturbed zinc coating under the PVC coating, fulfilling the requirement of NEMA RN-1 regarding the restriction of harmed or eroded zinc coating over the conduit.
- Ocal® is UL® Listed with both the zinc coating and the PVC coating investigated and listed per UL6.
- Ocal® is UL® Listed including UV resistance testing
- Ocal® has "Double-Coat" coated fittings, enhancing corrosion protection by applying coating to the interior and exterior of the fittings before PVC coating.

Which line of PVC-coated conduit, fittings and accessories can you trust to provide a complete corrosion-protection package for your entire electrical raceway system, extending its life for years to come? Ocal-Blue®.

At T&B, we're committed to:

- Convenience of single-order, single-shipment to your site for thousands of stocking items
- Expert local point of contact for clear, consistent information regarding training, codes and standards
- Quality brands that have proven themselves over time
- Inventive design and manufacture of problem-solving products
- Offering a best-of-class warranty and returns policy
- Uniform carton labeling with additional bar-coding for convenient inventory management
- Nationwide network of stocking electrical distributors
- Outstanding customer service capability
- Supplying you with the right products, convenient packaging, on-time delivery and competitive pricing

We deliver the solutions that make your job easier and offer the power to bring it all together in one package. Call us today and let us help you profit from sourcing your electrical products from the leader, Thomas & Betts.



Water & Wastewater Treatment



Food & Beverage Processing



Mining



Petrochemical Processing



Transportation Infrastructure



Customer Service

1-800-816-7809

Immediate, Knowledgeable Assistance

Every Thomas & Betts Customer Service Representative is right where the action is — surrounded by all the support and information they need to answer your questions and fill your orders faster than ever. Your calls and faxes are automatically routed to Customer Service Specialists who personally serve your account and can answer questions about products, order status, price and availability, and other service-related inquiries.

Phone: 1-800-816-7809

Fax: 1-800-816-7810

Email: generalcustomerserviceteam@tnb.com



T&B Access[®]

tnbaccess.tnb.com

T&B Access[®] is a global sales tool for our distributor partners, offering:

- Quote Requests
- Stock Checks
- Pricing Inquiries
- Cross Reference
- Order Entry
- Order Resolution
- Shipping Status
- Document Look-Up
- Automatic Order Receiving
- Item History Search
- Multiple-Location User Search
- Context-Sensitive Help
- Shipping Confirmations
- Tracking Data
- Expediting
- Returns Processing
- Quality Issues
- Customer Report Cards
- Web Catalog Look-Up

All of these tools and more are available online 24 hours a day – 7 days a week, without having to make a single phone call. Multi-lingual options are available in English, French and Spanish. T&B Access[®] now serves over 10,000 satisfied customer users at over 3,500 locations every month.

Contents

T&B Services	2-3
Overview	4-9
PVC-Coated Conduit and Accessories	10-17
PVC-Coated Conduit Bodies and Fittings	18-35
PVC-Coated Boxes and Covers	36-37
PVC-Coated Hazardous Location Fittings.....	38-45
PVC-Coated Strut and Accessories.....	46-51
Ocal [®] Installation Products.....	52-60
Technical Information	61-72
Catalog Number Index	73-80



Thomas & Betts

www.tnb.com

T&B Services

Technical Services

1-888-862-3289

Over 170 Years of Industry Experience

Meeting and exceeding our customers' expectations is a fundamental goal of Thomas & Betts. Call our Technical Services Department and talk LIVE to an expert who'll answer questions and concerns regarding all aspects of our products and services. Our experienced and knowledgeable staff is second to none in the industry!



Tool Services

1-800-284-TOOL

Quality You Can Trust

Trust T&B's dedicated Tool Services Department to answer all questions regarding tool applications, repair, warranties, sales/lease/rental and technical information. Ask about our specialized services, including customer/sales training, demos and calibration/certification of tools.



Web Catalog

www.tnb.com/webcatalog

Thousands of Products at Your Fingertips

U.S. contractors and specifiers have made our web catalog their number one stop. Users can search for technical information by catalog number, UPC code, competitor number, keyword search, product category and/or brand. Having found the item(s) they are searching for, they can then use our **Where To Buy** function to locate a T&B local distributor and/or other support services.



T&B Services

Web CAD Library

www.tnb.com/CADLibrary

Over 4,000 2D and 3D CAD Models Available FREE!

The T&B CAD Library is an on-line source of 2D and 3D CAD models, available FREE to customers who register. Users can download these files to their desktops for import into their working drawings. Drawings are offered in 90 of the most popular native file formats. This is a valuable tool for CAD designers, OEMs and engineering firms, as it will allow them to quickly locate and download T&B drawings into their projects. Over 4,000 drawings of T&B® Fittings, PMA® Cable Protection, Kindorf®, Red•Dot® and Superstrut® products and Steel City® and Carlon® Floor Boxes are currently available, and we're continually adding more products to the library.



BIM Library

Now available to you through Autodesk® Seek (seek.autodesk.com), our BIM (Building Information Modeling) objects can easily be imported to your Revit® models. These BIM objects are fully standards compliant, Revit® Certified and completely configurable.

Autodesk and Revit are registered trademarks of Autodesk, Inc.

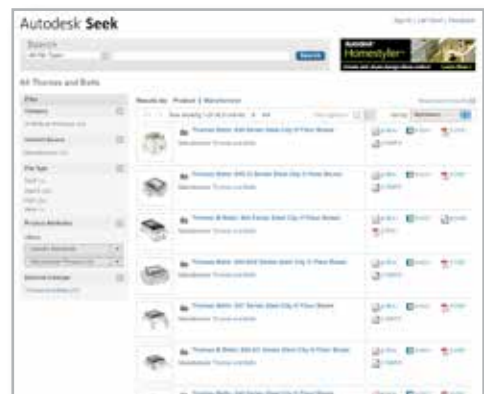

Overview

Better by Design

Ocal® PVC-coated conduit and fittings represent a complete corrosion-protection package for your entire conduit system. This extensive product line includes the largest number of items in stock along with corrosion-resistant supports and patching compounds. With Ocal® PVC-coated conduit and fittings, you get corrosion protection that will extend the life of your electrical raceway system for years and years.

A Complete Corrosion Protection Solution

- UL® Listed with both the zinc coating and the PVC coating investigated and listed per UL6.
- Industry leading thread protection through a hot-dipped galvanizing process, and industry leading UL® Listed Type 4X PVC-coated conduit bodies.
- A full undisturbed zinc coating under the PVC coating, fulfilling the requirement of NEMA RN-1 regarding the restriction of harmed or eroded zinc coating over the conduit.
- Meets the requirements of NEMA RN-1 without exception.
- UL® Listed including UV resistance testing.
- “Double-Coat” coated fittings, enhancing corrosion protection by applying coating to the interior and exterior of the fittings before PVC coating.
- Custom colors.
- On-site installation training and certification, and extended warranty on installations conducted by certified installers.



Standards Met

- ANSI C80.1
- Federal Specification WW-C-581
- NEMA RN-1
- UL6



Overview

What is corrosion?

Corrosive elements cause millions of dollars in damage through lost time, materials and labor.

Examples of Corrosion



Corrosion Protection of Electrical Conduit Systems

Corrosion Protection Options

CHEMICAL CATEGORY	CHEMICAL EXAMPLES	PVC	URETHANE	304 STAINLESS STEEL	316 STAINLESS STEEL	POLY CARBONATE	CAST IRON	BRASS	ALUMINUM
		COMPATIBILITY RATING							
Solvents (excluding alcohols and aliphatic)	Acetone, toluene, ketones, etc.	NR	NR	L	L	NR	L	L	L
Fuels	Jet fuel (alcohol based and aliphatic solvent based)	L	L	L	L	L	L	L	L
Plating Solutions	Chrome, nickel, copper, brass, gold, zinc, etc.	L	F	F	F	F	NR	NR	NR
Salts and Alkaline Materials	Caustic soda, caustic potash, alkaline cleaners, etc.	L	F	L	L	F	NR	NR	NR
Mild Acids	Low-concentration hydrochloric, sulfuric, fruit acids, glycolic, citric, etc.	L	S	L	L	S	NR	NR	NR
Strong or High-Purity Acids	Nitric, hydrofluoric, etc.	S	S	F	F	S	NR	NR	NR
Oxidizing Agents	Bleach, chlorine, hydrogen peroxide, etc.	L	S	L	L	S	NR	NR	NR

Chemical Compatibility Legend

SUITABILITY DESCRIPTION	COMPATIBILITY RATING
Rated for all Fumes, Splash & Liquid	L
Rated only for Fumes & Splash	S
Rated for Fumes only	F
Not Recommended	NR

The chart **above** provides a general guide for the end user to choose the most suitable material for corrosion protection. Compatibility with chemical environment should be thoroughly evaluated for each installation.

As you can see, PVC-coated conduit and fittings are suitable for almost all applications. When it comes to PVC-coated conduit systems, there is no higher quality than Ocal®.

Overview

Ocal manufacturing process

Introduction

The Ocal® PVC-coated conduit system fully complies with all standards for proper use and protection in corrosive environments mandated by UL6, NEMA RN-1 and ANSI C80.1. It is manufactured right here in the United States by Thomas & Betts in our Jonesboro, AR manufacturing facility.

The Process of Manufacturing PVC-Coated Conduit

- 1 The process begins with 20-foot sticks of raw steel shell.
- 2 The steel shell is cut, threaded and prepared for the hot-dip galvanizing process.
- 3 The threaded shell is immersed in a molten zinc bath. This hot-dip galvanizing process enables the zinc to penetrate the steel, providing the best possible protection. After the conduit is extracted from the zinc bath, super-heated steam is blown through the interior and over the outside of the conduit to remove any slag. The ends of the conduit are heated enough to blow excess zinc out of the thread cavities. Thomas & Betts manufactures steel conduit that hot-dip galvanizes the threads as well as the conduit itself. Other methods such as "hot galvanizing" provide only a sprayed-on zinc coating.
- 4 Prior to the exterior PVC coating, 2 mils (nominal) of blue urethane is applied to the inside diameter as well as the threads of each conduit. After priming, the conduit is heated and then rolled through liquid plastisol, achieving complete coverage of 40 mils in thickness.
- 5 Standard colors include gray, white and blue. Custom colors also available.



Ocal® offers

- Plant walk-throughs
- Installation training and certification
- Installation tools
- The expertise to ensure that you get the maximum benefit of the Ocal-Blue® total protection system
- Manufacturing capabilities that ensure unmatched delivery time on custom orders, special colors or large quantities
- Protection of each shipment with special packaging for damage-free delivery

Superior Service

Our reputation for dependability and customer service has made Ocal® the most trusted name in corrosion protection for the electrical industry.



Overview

Complete corrosion protection

Ocal® has developed a process for coating the interior and exterior of all fittings with a nominal .002" (2 mils) of blue urethane, which is baked on. This proprietary application of urethane enhances the corrosion protection of your system, even if you accidentally nick or cut the PVC coating during installation.

Flexible, overlapping sleeves on all Ocal® fittings guarantee protection with a vapor- and moisture-tight seal at every connection.

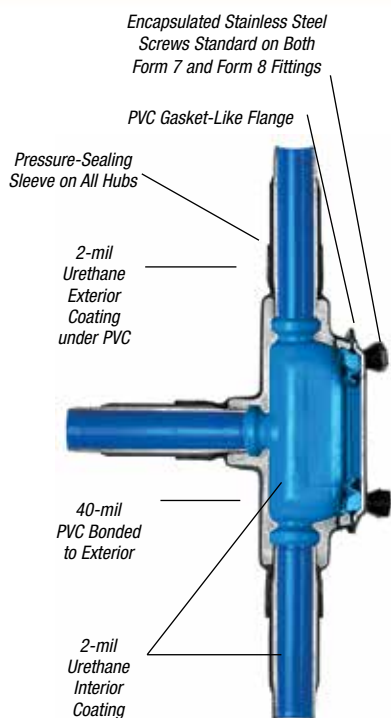

Ocal supplies encapsulated screws on both Form 7 and Form 8 fittings.



The Process of Manufacturing PVC-Coated Fittings

- 1 Fittings are cleaned and then sprayed inside and outside with 2 mils (nominal) of blue urethane. This gives the fittings corrosion protection on the exterior as well as the interior — all fittings are “double-coated.”
- 2 40 mils of PVC is applied to the exterior of the fitting.
- 3 Covers are coated with a molded flange and molded integral O-ring seal for 2½" – 4" Form 8 and all Form 7. Conduit bodies are molded with a flat surface to ensure a superior seal.
- 4 Standard colors include gray, white and blue. Custom colors also available.

Thomas & Betts takes pride in providing PVC-coated conduit and fittings compliant with industry wide recognized standards.

It is this dedication to superior quality that makes Ocal “Better by Design.”



2" C Form 8 conduit body and cover

Ocal-Blue® Double-Coat UL® Listed Type 4X Form 8 Conduit Bodies

UL® Listed Type 4X and NEMA 4X!

For the conduit system that has to stand up to a corrosive environment, the newly designed Ocal-Blue® Type 4X Form 8 conduit body meets the challenge. The key is in the cover. Ocal® takes a cast cover and then injection molds a PVC coating around it with an integral O-ring seal.

There's no need for tools or gaskets. To meet the harsh requirements of the UL® Type 4X listing, you need only hand-tighten the stainless steel encapsulated screws to 15 in.-lbs. of torque — as compared to the 35 in.-lbs. of torque required to tighten cover screws on competitors' conduit bodies.

Ideal for providing corrosion-resistant performance in washdown and other tough applications, Ocal-Blue® Type 4X Form 8 PVC-coated cast-iron conduit bodies are now available in sizes up to 2". Look for the blue to know it's a high-quality Thomas & Betts product.

Overview

Evaluating corrosion protection of PVC-coated conduit

When evaluating any electrical raceway conduit or fittings, **applicable standards** should be referenced. The three standards that address the design and performance of PVC-coated rigid steel conduit are **ANSI C80.1, UL6 and NEMA RN-1**. ANSI C80.1, UL® and NEMA have determined the appropriate ASTM standards and test methods that apply.

Hot-Dip Galvanized Threads

Since electrical conduit systems breathe, the threads will be exposed to the corrosive environment for the duration of the installation. NEMA RN-1-2005 is the electrical industry's standard for PVC externally coated galvanized rigid steel conduit. Section 2.1 of this standard states, "Where unusually corrosive environments are encountered, it is recommended that threads be given additional protection suitable for the intended application." Hot-dip galvanizing is the process through which the steel shell is dipped in molten zinc, causing the zinc to penetrate the steel. Ocal® hot-dip galvanizes the threads of the conduit, in addition to the conduit itself. This gives the threads the protection necessary in corrosive environments.

A compelling demonstration of the protection hot-dip galvanizing provides is shown below, using a common corrosive agent, salt, on hot-dip galvanized threads versus threads that are spray galvanized. UL6, the standard for rigid metal conduit, references ASTM B117 for evaluating protective coatings. Below are the results of a salt-fog test using the standard test method ASTM B117.

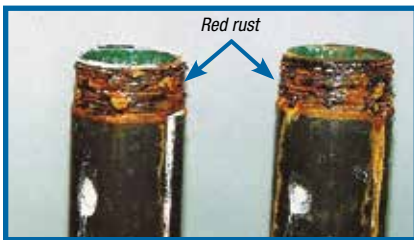

Examples of Spray-Galvanized (Hot-Galvanized) Threads after 42-day salt-fog test



Examples of Hot-Dip Galvanized Threads after 42-day salt-fog test

Galvanized conduit underneath the PVC coating — Preece Test

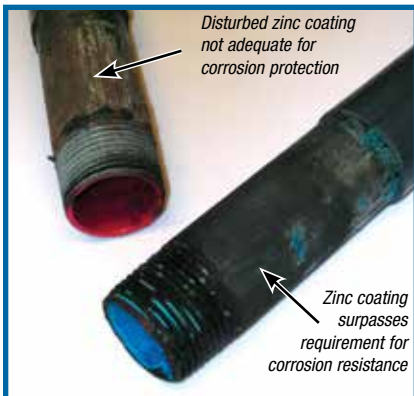

With so much riding on the integrity of their electrical conduit systems, facilities need the superior protection offered by the Thomas & Betts Ocal® PVC-coated conduit systems. The simple fact is that Ocal® PVC-coated conduit system complies fully with the design and performance standards for PVC-coated conduit set forth by UL6, NEMA RN-1 and ANSI C80.1.

ANSI C80.1, UL6 and NEMA RN-1 have determined the appropriate ASTM standards and test methods that apply, and the Preece test is one test that must be passed to be in full compliance.

Why is the Preece test relevant to PVC-coated conduit?

In cases where the PVC protection is accidentally breached, resulting from cuts, scrapes, etc., it is critical to have a second line of defense — a zinc, or galvanized, coating. The zinc coating will significantly slow corrosion and allow more time for repairs. Conduit systems without adequate zinc protection underneath the PVC coating are most likely to suffer catastrophic corrosion damage. This is why NEMA RN-1 section 3.1.1 requires the proper and correct treatment of galvanized conduit before it is PVC coated. It states, **"The surface shall be cleaned in such a manner that the galvanized surface of the conduit is not harmed or eroded."**

The purpose of the Preece test is to evaluate the zinc coating on galvanized rigid conduit to ensure adequate protection from corrosion per UL6.2.2. The test will also determine if the surface of the conduit has been damaged as a result of preparation for PVC coating.

In evaluating the test results, the conduit receives a passing grade when the sample does not show a bright, adherent deposit of copper after four 60-second immersions in the copper sulfate solution. The conduit showing the bright, firmly adhering copper has failed to provide adequate zinc protection against corrosion.

The Preece test follows procedures set forth by UL6.2.2 and ASTM A239 and is the test recognized by UL6, NEMA RN-1 and ANSI C80.1 to adequately assess zinc protection for rigid steel conduit. The Ocal® line of PVC-coated conduit systems, manufactured by Thomas & Betts, complies with UL6, NEMA RN-1 and ANSI C80.1 without exception.

Overview

Adhesion test

The evaluation process for adhesion of PVC coating on conduit is governed by NEMA RN-1 section 3.8, Adhesion, which states, "The adhesion of the PVC coating to the conduit shall be greater than the strength of the coating itself." This adhesion test is straightforward and simple. There are no specialized conditions necessary to perform this test. Ocal® routinely performs quality-control testing — including the adhesion test — on conduit as it rolls off the line. Conduit that passes this test demonstrates that the adhesion will provide years of trouble-free service.

The following demonstration shows Ocal® PVC-coated conduit being subjected to the adhesion test.



Step 1 consists of two cuts through the plastic to the substrate along the length of the conduit, approximately ½" apart and 3" to 4" in length. A third, perpendicular cut crosses the lengthwise parallel cuts.



Step 2 calls for the edge of the PVC that was cut on the perpendicular to be carefully lifted to form a plastic tab.



In **Step 3**, the tab is pulled perpendicular to the conduit with a pair of pliers. The plastic tab will tear off rather than having any peeling effect or the coating separating from the substrate.



Step 4 is the evaluation of the test, which in this case, results in a passing grade for Ocal. This result is more testimony to the fact that Ocal is "Better by Design."

Results

With Ocal® PVC-coated conduit and fittings, you get corrosion protection that will extend the life of your electrical raceway systems for years and years.



PVC-Coated Conduit and Accessories

The ultimate in corrosion protection!

Ocal-Blue® Conduit

- Hot-dip galvanized steel or aluminum conduit
- Nominal .002" (2 mil) blue urethane coating on interior
- Hot-dipped galvanized threads (steel)
- Minimum .040" (40 mil) PVC coating on exterior — in your choice of blue, white, gray or custom colors
- Color-coded thread protectors
- Couplings shipped with conduit are packaged separately



CAT. NO.		PIPE SIZE IN.	OUTSIDE DIAMETER	OUTSIDE DIAMETER	NOMINAL WALL THICKNESS	NOMINAL WALL THICKNESS	NOMINAL INSIDE DIAMETER	CROSS SECTION AREA IN SQUARE	LENGTH WITHOUT COUPLINGS	MINIMUM WEIGHT PER FOOT PER FOOT
STEEL	ALUMINUM	METRIC SIZE DESIGNATOR*	STEEL ONLY IN. MM	WITH PVC IN. MM	STEEL ONLY IN. MM	WITH PVC IN. MM	IN. MM	IN. MM	FT. M	STEEL ONLY LBS. KG
COND1/2-	COND1/2SA-	1/2	.84	.92	.10	.14	.63	.30	9'11 1/4"	.79
		16	21.30	23.30	2.64	3.56	16.10	7.72	3.03	.36
COND3/4-	COND3/4SA-	3/4	1.05	1.13	.11	.15	.84	.53	9'11 1/4"	1.05
		21	26.70	28.70	2.71	3.73	21.20	13.53	3.03	.48
COND1-	COND1SA-	1	1.32	1.40	.13	.17	1.06	.86	9'11"	1.53
		27	33.40	35.40	3.20	4.21	27.00	21.94	3.02	.69
COND1-1/4-	COND1-1/4SA-	1 1/4	1.66	1.74	.13	.17	1.39	1.50	9'11"	2.01
		35	42.20	44.10	3.37	4.39	35.40	37.97	3.02	.91
COND1-1/2-	COND1-1/2SA-	1 1/2	1.90	1.98	.14	.18	1.62	2.04	9'11"	2.40
		41	48.30	50.20	3.50	4.52	41.20	51.71	3.02	1.09
COND2-	COND2SA-	2	2.38	2.46	.15	.19	2.08	3.36	9'11"	3.32
		53	60.30	62.30	3.70	4.72	52.90	85.21	3.02	1.51
COND2-1/2-	COND2-1/2SA-	2 1/2	2.88	2.96	.19	.23	2.49	4.80	9'10 1/2"	5.27
		63	73.00	75.00	4.90	5.91	63.20	121.61	3.01	2.39
COND3-	COND3SA-	3	3.50	3.58	.21	.25	3.09	7.39	9'10 1/2"	6.83
		78	88.90	90.90	5.20	6.22	78.50	187.80	3.01	3.10
COND3-1/2-	COND3-1/2SA-	3 1/2	4.00	4.08	.22	.26	3.57	9.87	9'10 1/4"	8.31
		91	101.60	103.60	5.46	6.47	90.70	250.60	3.00	3.77
COND4-	COND4SA-	4	4.50	4.58	.23	.27	4.05	12.73	9'10 1/4"	9.73
		103	114.30	116.30	5.71	6.73	102.90	323.34	3.00	4.41
COND5-	COND5SA-	5	5.56	5.64	.25	.29	5.07	20.01	9'10"	13.14
		129	141.30	143.30	6.22	7.23	128.90	508.15	3.00	5.96
COND6-	COND6SA-	6	6.63	6.71	.27	.31	6.09	28.89	9'10"	17.46
		155	168.30	170.30	6.75	7.87	154.80	733.83	3.00	7.92

Note — Inches, feet and pounds are indicated in bold type. Metric measure is directly below bold type.

* Metric size designator (ANSI C80.1-1994).

CAT. NO.	SIZE	MATERIAL	COLOR
COND3/4	-	Blank = Steel	_ = space for color identifier
		SA = Aluminum	G = Gray
			W = White
			B = Blue

Catalog No. Example:
COND3/4-G is 3/4" steel conduit coated in gray PVC.

Custom colors also available.



PVC-Coated Conduit and Accessories

Corrosion-protected connections for conduit sections.

Ocal-Blue® Couplings

- Nominal .002" (2 mil) blue urethane coating on interior and threads
- Minimum .040" (40 mil) PVC coating bonded to exterior — in your choice of blue, white, gray or custom colors
- Straight threads (NPS)
- Molded ribs on outer coating for easy installation (up to and including 4" trade size)
- Pressure-sealing sleeves protect your connection



CAT. NO.		COUPLING SIZE IN. METRIC SIZE DESIGNATOR*	MIN. LENGTH OF METAL IN. MM	TOTAL MIN. LENGTH INCLUDING SLEEVE IN. MM	WEIGHT STEEL ONLY LBS. KG
STEEL	ALUMINUM				
CPL1/2-	CPL1/2SA-	½	1.50	3.75	.13
		16	38.10	95.25	.06
CPL3/4-	CPL3/4SA-	¾	1.53	3.75	.19
		21	38.91	95.25	0.85
CPL1-	CPL1SA-	1	1.91	4.94	0.33
		27	48.41	139.70	.15
CPL1-1/4-	CPL1-1/4SA-	1¼	1.91	5.50	0.43
		35	48.41	139.70	.19
CPL1-1/2-	CPL1-1/2SA-	1½	1.91	5.75	0.56
		41	48.41	146.05	.25
CPL2-	CPL2SA-	2	1.94	5.94	0.77
		53	49.19	150.79	.35
CPL2-1/2-	CPL2-1/2SA-	2½	2.88	6.88	1.85
		63	73.10	174.70	.83
CPL3-	CPL3SA-	3	3.03	7.03	2.70
		78	76.98	178.58	1.22
CPL3-1/2-	CPL3-1/2SA-	3½	3.09	7.09	3.78
		91	78.58	180.18	1.70
CPL4-	CPL4SA-	4	3.19	7.19	3.08
		103	80.97	182.57	1.39
CPL5-	CPL5SA-	5	3.37	7.37	5.00
		129	85.69	187.29	2.25
CPL6-	CPL6SA-	6	3.44	7.44	8.00
		155	87.29	188.89	3.60

Note – Inches and pounds are indicated in bold type. Metric measure is directly below bold type.

* Metric size designator (ANSI C80.1-1994).

CAT. NO.	SIZE	MATERIAL	COLOR
CPL1	SA-		
		Blank = Steel	_ = space for color identifier
		SA = Aluminum	G = Gray
			W = White
			B = Blue
Catalog No. Example:			
CPL1SA-B is a 1" aluminum coupling coated in blue PVC.			
Custom colors also available.			

PVC-Coated Conduit and Accessories

Join threaded conduit where you can't use a standard coupling.

Ocal-Blue® Double-Coat Split Couplings

Split couplings serve as speed unions for cost-effective joining of two separate lengths of threaded conduit. Like other Ocal® fittings, they're double coated in urethane and PVC to safeguard your entire conduit system against corrosion.

- Malleable iron construction
- Nominal .002" (2 mil) blue urethane on both interior and exterior
- Minimum .040" (40 mil) PVC bonded to exterior
- PVC coating in your choice of blue, white and gray standard colors with custom colors available on request
- Stainless steel hardware included



TCC Split Coupling

CAT. NO.	PIPE SIZE IN. METRIC SIZE DESIGNATOR*
TCC1- <u> </u>	½ 16
TCC2- <u> </u>	¾ 21
TCC3- <u> </u>	1 27
TCC4- <u> </u>	1¼ 35
TCC5- <u> </u>	1½ 41
TCC6- <u> </u>	2 53

CAT. NO.	PIPE SIZE IN. METRIC SIZE DESIGNATOR*
TCC7- <u> </u>	2½ 63
TCC8- <u> </u>	3 78
TCC9- <u> </u>	3½ 91
TCC10- <u> </u>	4 103
TCC12- <u> </u>	5 129
TCC14- <u> </u>	6 155

CAT. NO.	COLOR
TCC1- <u> </u>	<u> </u>
<u> </u> = space for color identifier	
G = Gray	
W = White	
B = Blue	
Custom colors also available.	

Note: The use of standard couplings is recommended whenever possible over the use of split couplings, because standard couplings provide better overall corrosion protection.

* Metric size designator (ANSI C80.1-1994).

Speed up your field installations with pre-threaded conduit nipples!

Ocal-Blue® Nipples

- Made from Ocal® PVC-coated steel or aluminum conduit
- Blue urethane coating over threads
- Nominal .002" (2 mil) blue urethane on interior
- Minimum .040" (40 mil) PVC coating on exterior — choose blue, white, gray or custom colors
- Color-coded thread protectors for easy identification of conduit size
- Available in 11 standard lengths — close and 2" to 12" with custom lengths available on request
- Close nipples are coated only in urethane



CAT. NO.	SIZE X LENGTH	MATERIAL	COLOR
NPL3/4x6	<u> </u> - <u> </u>	<u> </u>	<u> </u>
<u> </u> = space for color identifier			
Blank = Steel		<u> </u> = space for color identifier	
SA = Aluminum		G = Gray	
		W = White	
		B = Blue	
Catalog No. Example: NPL3/4X6-G is a ¾" x 6" long steel nipple coated in gray PVC.		Custom colors also available.	

PVC-Coated Conduit and Accessories

Ocal-Blue® Nipples (continued)



PVC-Coated Conduit Nipples — Steel

PIPE SIZE IN. METRIC SIZE*	NIPPLE LENGTH										
	CLOSE	2" 50.8	2½" 63.5	3" 76.2	3½" 88.9	4" 101.6	5" 127.0	6" 152.4	8" 203.2	10" 254.0	12" 304.8
½ 16	CLNPL1/2- _	NPL1/2X2- _	NPL1/2X2½- _	NPL1/2X3- _	NPL1/2X3½- _	NPL1/2X4- _	NPL1/2X5- _	NPL1/2X6- _	NPL1/2X8- _	NPL1/2X10- _	NPL1/2X12- _
¾ 21	CLNPL3/4- _	NPL3/4X2- _	NPL3/4X2½- _	NPL3/4X3- _	NPL3/4X3½- _	NPL3/4X4- _	NPL3/4X5- _	NPL3/4X6- _	NPL3/4X8- _	NPL3/4X10- _	NPL3/4X12- _
1 27	CLNPL1- _	NPL1X2- _	NPL1X2½- _	NPL1X3- _	NPL1X3½- _	NPL1X4- _	NPL1X5- _	NPL1X6- _	NPL1X8- _	NPL1X10- _	NPL1X12- _
1¼ 35	CLNPL1¼- _	NPL1¼X2- _	NPL1¼X2½- _	NPL1¼X3- _	NPL1¼X3½- _	NPL1¼X4- _	NPL1¼X5- _	NPL1¼X6- _	NPL1¼X8- _	NPL1¼X10- _	NPL1¼X12- _
1½ 41	CLNPL1½- _	NPL1½X2- _	NPL1½X2½- _	NPL1½X3- _	NPL1½X3½- _	NPL1½X4- _	NPL1½X5- _	NPL1½X6- _	NPL1½X8- _	NPL1½X10- _	NPL1½X12- _
2 53	CLNPL2- _	—	NPL2X2½- _	NPL2X3- _	NPL2X3½- _	NPL2X4- _	NPL2X5- _	NPL2X6- _	NPL2X8- _	NPL2X10- _	NPL2X12- _
2½ 63	CLNPL2½- _	—	—	—	NPL2½X3½- _	NPL2½X4- _	NPL2½X5- _	NPL2½X6- _	NPL2½X8- _	NPL2½X10- _	NPL2½X12- _
3 78	CLNPL3- _	—	—	—	NPL3X3½- _	NPL3X4- _	NPL3X5- _	NPL3X6- _	NPL3X8- _	NPL3X10- _	NPL3X12- _
3½ 91	CLNPL3½- _	—	—	—	—	NPL3½X4- _	NPL3½X5- _	NPL3½X6- _	NPL3½X8- _	NPL3½X10- _	NPL3½X12- _
4 103	CLNPL4- _	—	—	—	—	NPL4X4- _	NPL4X5- _	NPL4X6- _	NPL4X8- _	NPL4X10- _	NPL4X12- _
5 129	CLNPL5- _	—	—	—	—	—	NPL5X5- _	NPL5X6- _	NPL5X8- _	NPL5X10- _	NPL5X12- _
6 155	CLNPL6- _	—	—	—	—	—	NPL6X5- _	NPL6X6- _	NPL6X8- _	NPL6X10- _	NPL6X12- _

PVC-Coated Conduit Nipples — Aluminum

PIPE SIZE IN. METRIC SIZE*	NIPPLE LENGTH										
	CLOSE	2" 50.8	2½" 63.5	3" 76.2	3½" 88.9	4" 101.6	5" 127.0	6" 152.4	8" 203.2	10" 254.0	12" 304.8
½ 16	CLNPL1/2SA- _	NPL1/2X2SA- _	NPL1/2X2½SA- _	NPL1/2X3SA- _	NPL1/2X3½SA- _	NPL1/2X4SA- _	NPL1/2X5SA- _	NPL1/2X6SA- _	NPL1/2X8SA- _	NPL1/2X10SA- _	NPL1/2X12SA- _
¾ 21	CLNPL3/4SA- _	NPL3/4X2SA- _	NPL3/4X2½SA- _	NPL3/4X3SA- _	NPL3/4X3½SA- _	NPL3/4X4SA- _	NPL3/4X5SA- _	NPL3/4X6SA- _	NPL3/4X8SA- _	NPL3/4X10SA- _	NPL3/4X12SA- _
1 27	CLNPL1SA- _	NPL1X2SA- _	NPL1X2½SA- _	NPL1X3SA- _	NPL1X3½SA- _	NPL1X4SA- _	NPL1X5SA- _	NPL1X6SA- _	NPL1X8SA- _	NPL1X10SA- _	NPL1X12SA- _
1¼ 35	CLNPL1¼SA- _	NPL1¼X2SA- _	NPL1¼X2½SA- _	NPL1¼X3SA- _	NPL1¼X3½SA- _	NPL1¼X4SA- _	NPL1¼X5SA- _	NPL1¼X6SA- _	NPL1¼X8SA- _	NPL1¼X10SA- _	NPL1¼X12SA- _
1½ 41	CLNPL1½SA- _	NPL1½X2SA- _	NPL1½X2½SA- _	NPL1½X3SA- _	NPL1½X3½SA- _	NPL1½X4SA- _	NPL1½X5SA- _	NPL1½X6SA- _	NPL1½X8SA- _	NPL1½X10SA- _	NPL1½X12SA- _
2 53	CLNPL2SA- _	—	NPL2X2½SA- _	NPL2X3SA- _	NPL2X3½SA- _	NPL2X4SA- _	NPL2X5SA- _	NPL2X6SA- _	NPL2X8SA- _	NPL2X10SA- _	NPL2X12SA- _
2½ 63	CLNPL2½SA- _	—	—	—	NPL2½X3½SA- _	NPL2½X4SA- _	NPL2½X5SA- _	NPL2½X6SA- _	NPL2½X8SA- _	NPL2½X10SA- _	NPL2½X12SA- _
3 78	CLNPL3SA- _	—	—	—	NPL3X3½SA- _	NPL3X4SA- _	NPL3X5SA- _	NPL3X6SA- _	NPL3X8SA- _	NPL3X10SA- _	NPL3X12SA- _
3½ 91	CLNPL3½SA- _	—	—	—	—	NPL3½X4SA- _	NPL3½X5SA- _	NPL3½X6SA- _	NPL3½X8SA- _	NPL3½X10SA- _	NPL3½X12SA- _
4 103	CLNPL4SA- _	—	—	—	—	NPL4X4SA- _	NPL4X5SA- _	NPL4X6SA- _	NPL4X8SA- _	NPL4X10SA- _	NPL4X12SA- _
5 129	CLNPL5SA- _	—	—	—	—	—	NPL5X5SA- _	NPL5X6SA- _	NPL5X8SA- _	NPL5X10SA- _	NPL5X12SA- _
6 155	CLNPL6SA- _	—	—	—	—	—	NPL6X5SA- _	NPL6X6SA- _	NPL6X8SA- _	NPL6X10SA- _	NPL6X12SA- _

* Metric size designator (ANSI C80.1-1994).

PVC-Coated Conduit and Accessories

Factory bent to save wasted time and materials!

Ocal-Blue® Standard-Radius Elbows

- Fabricated from Ocal® PVC-coated conduit
- Standard radii in 30°, 45°, 60° and 90° available for immediate shipment
- Color-coded thread protectors for easy identification of conduit size



CAT. NO.		PIPE SIZE IN. METRIC SIZE DESIGNATOR*	RADIUS "R" IN. MM	OFFSET "C" IN. MM	STRAIGHT END "D" IN. MM	UNBENT LENGTH IN. MM	WEIGHT EACH STEEL ONLY LBS. KG
STEEL	ALUMINUM						
ELL1/2-_-	ELL1/2-_-SA-_-	½	4.00	6.00	2.00	10.28	.67
		16	101.60	152.40	50.80	261.19	16.95
ELL3/4-_-	ELL3/4-_-SA-_-	¾	4.50	6.50	2.00	11.07	.95
		21	114.30	165.10	50.80	281.14	24.07
ELL1-_-	ELL1-_-SA-_-	1	5.75	8.00	2.25	13.53	1.77
		27	146.05	203.20	57.15	343.71	44.97
ELL1 1/4-_-	ELL1 1/4-_-SA-_-	1¼	7.25	9.50	2.25	15.89	2.55
		35	184.15	241.30	57.15	403.56	64.80
ELL1 1/2-_-	ELL1 1/2-_-SA-_-	1½	8.25	11.00	2.75	18.46	3.98
		41	209.55	279.40	69.85	468.86	101.13
ELL2-_-	ELL2-_-SA-_-	2	9.50	13.00	3.50	21.92	6.33
		53	241.30	330.20	88.90	556.83	160.86
ELL2 1/2-_-	ELL2 1/2-_-SA-_-	2½	10.50	14.00	3.50	23.49	9.65
		63	266.70	355.60	88.90	596.73	245.09
ELL3-_-	ELL3-_-SA-_-	3	13.00	16.50	3.50	27.42	15.42
		78	330.20	419.10	88.90	696.48	391.77
ELL3 1/2-_-	ELL3 1/2-_-SA-_-	3½	15.00	20.75	5.75	35.06	23.30
		91	381.00	527.05	146.05	890.57	591.84
ELL4-_-	ELL4-_-SA-_-	4	16.00	21.75	5.75	36.63	29.68
		103	406.40	552.45	146.05	930.47	753.80
ELL5-_-	ELL5-_-SA-_-	5	24.00	31.00	7.00	51.70	60.82
		129	609.60	787.40	177.80	1313.16	1544.89
ELL6-_-	ELL6-_-SA-_-	6	30.00	39.00	9.00	65.12	85.69
		155	762.00	990.60	228.60	1654.15	2176.51

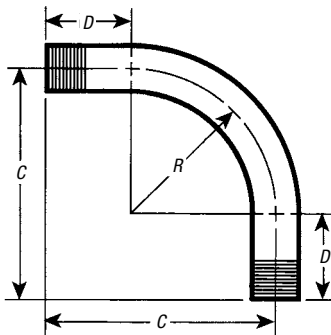

ITEM	PIPE SIZE	ANGLE	MATERIAL	COLOR
ELL 3/4-	-	-	-	-
	30 = 30°	Blank = Steel	G = Gray	
	45 = 45°	SA = Aluminum	W = White	
	60 = 60°		B = Blue	
	Blank = 90°			

Catalog No. Example:
ELL3/4SA-W is a ¾" trade size 90° aluminum elbow coated in white PVC.

Custom colors also available.

PVC-Coated Conduit and Accessories

Choose the size and angle to meet your exact requirements.

Ocal-Blue® Large-Radius Elbows

- Fabricated from Ocal® PVC-coated conduit
- Large radius in 90° available for immediate shipment
- Special radii and angles not listed available upon request
- Color-coded thread protectors for easy identification of conduit size



Conduit & Fittings — Ocal® Corrosion-Resistant Conduit Systems

CAT. NO.		PIPE SIZE IN. METRIC SIZE DESIGNATOR*	RADIUS "R" IN. MM	OFFSET "C" FT./IN. MM	STRAIGHT END "D" IN. MM	UNBENT LENGTH FT./IN. MM
STEEL	ALUMINUM					
LRELL_X12-_-	LRELL_X12-_-SA-_-	1-2½ 27-63	12.00 304.80	1' 9" 533.40	9.00 228.60	3' 0" 914.40
LRELL_X15-_-	LRELL_X15-_-SA-_-	1-3 27-78	15.00 381.00	2' 0" 609.60	9.00 228.60	3' 6" 1066.80
LRELL_X18-_-	LRELL_X18-_-SA-_-	1-4 27-103	18.00 457.20	2' 4" 711.20	10.00 254.00	4' 0" 1219.20
LRELL_X24-_-	LRELL_X24-_-SA-_-	1-4 27-103	24.00 609.60	2' 11" 889.00	11.00 279.40	4' 11" 1498.60
LRELL_X30-_-	LRELL_X30-_-SA-_-	1-5 27-129	30.00 762.00	3' 5" 1041.40	11.00 279.40	5' 9" 1752.60
LRELL_X36-_-	LRELL_X36-_-SA-_-	1-6 27-155	36.00 914.40	3' 11" 1193.80	11.00 279.40	6' 6" 1981.20
LRELL_X42-_-	LRELL_X42-_-SA-_-	1-6 27-155	42.00 1066.80	4' 6" 1371.60	12.00 304.80	7' 6" 2286.00
LRELL_X48-_-	LRELL_X48-_-SA-_-	1-6 27-155	48.00 1219.20	5' 0" 1524.00	12.00 304.80	8' 6" 2590.80
LRELL_X60-_-	LRELL_X60-_-SA-_-	2½-6 63-155	60.00 1524.00	6' 0" 1828.80	12.00 304.80	9' 10" 2997.20

* Metric size designator (ANSI C80.1-1994).

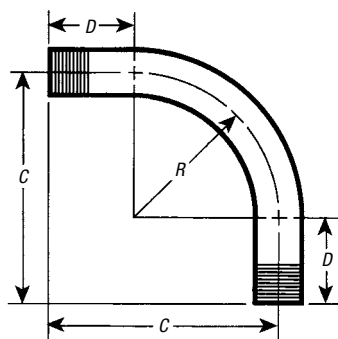

ITEM	PIPE SIZE	RADIUS	ANGLE	MATERIAL	COLOR
LRELL_X12-					
	1 = 1"		30 = 30°	Blank = Steel	G = Gray
	2 = 2"		45 = 45°	SA = Aluminum	W = White
	etc.		60 = 60°		B = Blue
			Blank = 90°		

Catalog No. Example:
LRELL3X18-45-G is a 3" trade size steel elbow with a radius of 18" and an angle of 45°, coated in gray PVC.

Custom colors also available.

PVC-Coated Conduit and Accessories

PVC coating evenly molded around saddle prevents exposure of metal — an Ocal® exclusive!

Ocal® PVC-Coated Beam Clamps and U-Bolts

- Beam clamps support and attach conduit runs to structural beams
- Molded right-angle beam clamps and U-bolts provide extra protection
- Encapsulated, hex-shaped nuts fit standard wrenches
- Stainless steel hardware included
- Parallel (PAR) and edge (EC) clamps feature nominal .015" (15 mil) PVC coating for corrosion protection
- Right-Angle clamps (RA) and U-Bolts (UB) feature nominal .040" (40 mil) PVC coating for corrosion protection



Parallel (PAR)



Edge (EC)

PVC-Coated Beam Clamps

CAT. NO.			PIPE SIZE	
RIGHT ANGLE	PARALLEL	EDGE	IN.	METRIC SIZE DESIGNATOR*
RA1/2-__	PAR1/2-__	EC1/2-__	½	16
RA3/4-__	PAR3/4-__	EC3/4-__	¾	21
RA1-__	PAR1-__	EC1-__	1	27
RA1-1/4-__	PAR1-1/4-__	EC1-1/4-__	1¼	35
RA1-1/2-__	PAR1-1/2-__	EC1-1/2-__	1½	41
RA2-__	PAR2-__	EC2-__	2	53
RA2-1/2-__	PAR2-1/2-__	—	2½	63
RA3-__	PAR3-__	—	3	78
RA3-1/2-__	PAR3-1/2-__	—	3½	91
RA4-__	PAR4-__	—	4	103

CAT. NO.	COLOR
RA 1- _____	
____ = space for color identifier	
G = Gray	
W = White	
B = Blue	
Custom colors also available.	



Right Angle (RA)

PVC-Coated U-Bolts

CAT. NO.	PIPE SIZE		"A" DIMENSION	
	IN.	METRIC SIZE DESIGNATOR*	IN.	MM
UB1/2-__	½	16	1.38	34.93
UB3/4-__	¾	21	1.56	39.69
UB1-__	1	27	1.84	46.83
UB1-1/4-__	1¼	35	2.19	55.56
UB1-1/2-__	1½	41	2.50	63.50
UB2-__	2	53	2.97	75.41
UB2-1/2-__	2½	63	3.47	88.11
UB3-__	3	78	4.09	103.98
UB3-1/2-__	3½	91	4.59	116.68
UB4-__	4	103	5.09	129.38
UB5-__	5	129	6.63	168.28
UB6-__	6	155	8.00	203.20

* Metric size designator (ANSI C80.1-1994).

ITEM	SIZE	COLOR
UB 1- _____		
____ = space for color identifier		
G = Gray		
W = White		
B = Blue		
Custom colors also available.		

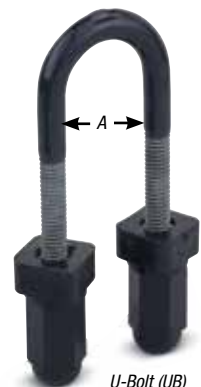

U-Bolt (UB)

PVC-Coated Conduit and Accessories

Support conduit on walls and structures.

Pipe Straps



One-Hole PVC-Coated Pipe Strap

Two-Hole PVC-Coated Pipe Strap

- Available in malleable iron/stamped steel with nominal .015" (15 mil) PVC coating in your choice of blue, white or gray or in 303 stainless steel
- Choose one- or two-hole versions
- Sized to allow for the extra thickness of the PVC coating



Two-Hole Stainless Steel Pipe Strap

One-Hole Stainless Steel Pipe Strap

303 Stainless Steel Pipe Straps for PVC-Coated Conduit

CAT NO.		PIPE SIZE IN. METRIC SIZE DESIGNATOR*	CONDUIT STRAP I.D. IN. MM	PVC-COATED CONDUIT O.D. IN. MM
ONE-HOLE 303 S.S. STRAP	TWO-HOLE 303 S.S. STRAP			
TS102-SS	TS902-SS	½	.92	.92
		16	23.37	23.37
TS103-SS	TS903-SS	¾	1.16	1.13
		21	29.46	28.70
TS104-SS	TS904-SS	1	1.51	1.40
		27	38.35	35.56
TS105-SS	TS905-SS	1¼	1.74	1.74
		35	44.20	44.20
TS106-SS	TS906-SS	1½	2.20	1.98
		41	55.88	50.29
HS107-SS	HS907-SS	2	2.88	2.46
		53	73.15	62.48
HS108-SS	HS908-SS	2½	3.50	2.96
		63	88.90	75.18
HS109-SS	HS909-SS	3	4.00	3.98
		78	101.60	101.09
HS110-SS	HS910-SS	3½	4.50	4.08
		91	114.30	103.63

* Metric size designator (ANSI C80.1-1994).

Use as spacers with one-hole pipe straps.

Ocal® PVC-Coated Clamp-Back Spacers



- Provides space for air flow between conduit and mounting surface
- Nominal .015" (15 mil) PVC coating for corrosion protection

CAT. NO.	PIPE SIZE IN. METRIC SIZE DESIGNATOR*
CB1/2-	½
	16
CB3/4-	¾
	21
CB1-	1
	27
CB1-1/4-	1¼
	35
CB1-1/2-	1½
	41
CB2-	2
	53
CB2-1/2-	2½
	63
CB3-	3
	78
CB3-1/2-	3½
	91
CB4-	4
	103

CAT. NO.	COLOR
CB1-	
	_ = space for color identifier
	G = Gray
	W = White
	B = Blue
	Custom colors also available.

PVC-Coated Conduit Bodies and Fittings

Easy access for pulling, splicing, mounting and maintenance!

Ocal-Blue® Double-Coat Conduit Bodies

With Ocal-Blue® Double-Coat Conduit Bodies, you can connect sections of conduit — with or without 90° bends — and provide easy access for wire pulling, making splices in branch conductors and maintenance and future system changes. Conduit bodies can also serve as mounting outlets for wiring devices and lighting fixtures.

- Type 4X Form 8 (½"–2") conduit bodies have injection-molded PVC-coated cover with integral O-ring seal
- Flat surface molded on conduit body seals with molded flange on cover on 2½"–4" Form 8 and all Form 7
- Available in Form 7 and Form 8 ferrous as well as Mark 9 and Form 7 aluminum
- All Ocal-Blue® conduit bodies offer double corrosion protection — both bodies and covers coated inside and out with a nominal .002" (2 mil) blue urethane, then exterior coated with a nominal .040" (40 mil) PVC
- PVC coating in your choice of blue, gray or white with custom colors available
- All threaded hubs fitted with pressure-sealing sleeves
- Conduit bodies ship complete with covers and encapsulated stainless steel screws
- Covers also sold separately for replacement or retrofit purposes



¾" T Form 8
conduit body
and cover



2 ½" LB Form 8 conduit body and cover





2 ½" LB Form 7 conduit body and cover



¾" X Form 7 conduit body and cover



¾" LB Mark 9 conduit body and cover

CAT. NO.	MATERIAL	COLOR
LB27-		
	Blank = Ferrous	_ = space for color identifier
	SA = Aluminum	G = Gray 
		W = White 
		B = Blue 
Catalog No. Example:		
LB27-W is a ¾" LB ferrous conduit body and cover coated in white PVC.		Custom colors also available.

PVC-Coated Conduit Bodies and Fittings

Ocal-Blue® Conduit Bodies Quick Reference

Note – Fittings shown uncoated

SHAPE	STYLE	SIZE (IN. AND METRIC SIZE DESIGNATOR*)									
		½" 16	¾" 21	1" 27	1¼" 35	1½" 41	2" 53	2½" 63	3" 78	3½" 91	4" 103
	Form 7	C17-	C27-	C37-	C47-	C57-	C67-	C77-	C87-	—	—
	Form 8	C18-4X-	C28-4X-	C38-4X-	C448-4X-	C58-4X-	C68-4X-	C78-	C88-	—	—
	Mark 9	C19-	C29-	C39-	C49-	C59-	C69-	C789-	C889-	C989-	C1089-
	Form 7 Aluminum	C17SA-	C27SA-	C37SA-	C47SA-	C57SA-	C67SA-	C77SA-	C87SA-	—	—
	Form 7	LU17-	LU27-	LU37-	LU47-	LU57-	LU67-	—	—	—	
	Form 8	LU18-4X-	LU28-4X-	LU38-4X-	LU448-4X-	LU58-4X-	LU68-4X-	—	—	—	
	Form 7	LB17-	LB27-	LB37-	LB47-	LB57-	LB67-	LB777-	LB87-	LB97-	LB107-
	Form 8	LB18-4X-	LB28-4X-	LB38-4X-	LB448-4X-	LB58-4X-	LB68-4X-	LB78-	LB888-	LB98-	LB108-
	Mark 9	LB19-	LB29-	LB39-	LB49-	LB59-	LB69-	LB789-	LB889-	LB989-	LB1089-
	Form 7 Aluminum	LB17SA-	LB27SA-	LB37SA-	LB47SA-	LB57SA-	LB67SA-	LB777SA-	LB87SA-	LB97SA-	LB107SA-
	Form 7	LL17-	LL27-	LL37-	LL47-	LL57-	LL67-	LL777-	LL87-	LL97-	LL107-
	Form 8	LL18-4X-	LL28-4X-	LL38-4X-	LL448-4X-	LL58-4X-	LL68-4X-	LL78-	LL888-	—	—
	Mark 9	LL19-	LL29-	LL39-	LL49-	LL59-	LL69-	LL789-	LL889-	LL989-	LL1089-
	Form 7 Aluminum	LL17SA-	LL27SA-	LL37SA-	LL47SA-	LL57SA-	LL67SA-	LL777SA-	LL87SA-	LL97SA-	LL107SA-
	Form 7	LR17-	LR27-	LR37-	LR47-	LR57-	LR67-	LR777-	LR87-	LR97-	LR107-
	Form 8	LR18-4X-	LR28-4X-	LR38-4X-	LR448-4X-	LR58-4X-	LR68-4X-	LR78-	LR888-	—	—
	Mark 9	LR19-	LR29-	LR39-	LR49-	LR59-	LR69-	LR789-	LR889-	LR989-	LR1089-
	Form 7 Aluminum	LR17SA-	LR27SA-	LR37SA-	LR47SA-	LR57SA-	LR67SA-	LR777SA-	LR87SA-	LR97SA-	LR107SA-
	Form 7	T17-	T27-	T37-	T47-	T57-	T67-	T77-	T87-	T97-	T107-
	Form 8	T18-4X-	T28-4X-	T38-4X-	T448-4X-	T58-4X-	T68-4X-	T78-	T88-	—	—
	Mark 9	T19-	T29-	T39-	T49-	T59-	T69-	T789-	T889-	T989-	T1089-
	Form 7 Aluminum	T17SA-	T27SA-	T37SA-	T47SA-	T57SA-	T67SA-	T77SA-	T87SA-	T97SA-	T107SA-
	Form 7	TB17-	TB27-	TB37-	TB47-	TB57-	TB67-	—	—	—	—
	Form 8	TB18-4X-	TB28-4X-	TB38-4X-	TB448-4X-	TB58-4X-	TB68-4X-	—	—	—	—
	Mark 9	TB19-	TB29-	TB39-	TB49-	—	—	—	—	—	—
	Form 7 Aluminum	TB17SA-	TB27SA-	TB37SA-	TB47SA-	TB57SA-	TB67SA-	—	—	—	—
	Form 7	X17-	X27-	X37-	X47-	X57-	X67-	—	—	—	—
	Form 8	X18-4X-	X28-4X-	X38-4X-	X448-4X-	X58-4X-	X68-4X-	—	—	—	—
	Mark 9	X19-	X29-	X39-	—	—	—	—	—	—	—
	Form 7 Aluminum	X17SA-	X27SA-	X37SA-	X47SA-	X57SA-	X67SA-	—	—	—	—

Ocal-Blue® Conduit Body Covers

STYLE	SIZE (IN. AND METRIC SIZE DESIGNATOR*)										
	½" 16	¾" 21	1" 27	1¼" 35	1½" 41	2" 53	2½" 63	3" 78	3½" 91	4" 103	
	Form 7	170F-	270F-	370F-	470F-	570F-	670F-	870F-	870F-	970F-	970F-
	Form 8	180F-4X-	280F-4X-	380F-4X-	480F-4X-	580F-4X-	680F-4X-	880F-	880F-	980F-	980F-
	Mark 9	190-	290-	390-	490-	590-	690-	889-	889-	989-	989-
	Form 7 Aluminum	170SA-	270SA-	370SA-	470SA-	570SA-	670SA-	870SA-	870SA-	970SA-	970SA-

* Metric size designator (ANSI C80.1-1994).

PVC-Coated Conduit Bodies and Fittings

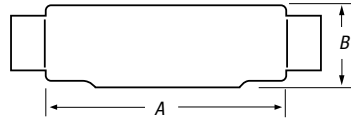

C Form 7 Ferrous Conduit Bodies with Covers

CAT. NO.	HUB SIZE*	DIMENSIONS (IN. AND MM)**					VOL. CAP. (CU.IN./CU.CM)
		A	B	C	D	E	
C17-	½"	5.45	1.40	1.45	.95	3.20	4.00
16		138.43	35.56	36.83	24.13	81.28	65.55
C27-	¾"	6.05	1.60	1.65	1.15	3.80	6.60
21		153.67	40.64	41.91	29.21	96.52	108.15
C37-	1"	6.75	1.90	1.80	1.35	4.55	10.60
27		171.45	48.26	45.72	34.29	115.57	173.70
C47-	1¼"	7.30	2.30	2.20	1.80	5.00	18.80
35		185.42	58.42	55.88	45.72	127.00	308.08
C57-	1½"	8.60	2.60	2.45	2.05	5.45	26.40
41		218.44	66.04	62.23	52.07	138.43	432.62
C67-	2"	9.50	3.20	3.05	2.45	6.40	51.00
53		241.30	81.28	77.47	62.23	162.56	835.74
C77-	2½"	12.10	3.65	4.25	3.60	8.40	102.00
63		307.34	92.71	107.95	91.44	213.36	1671.48
C87-	3"	12.10	4.40	4.25	3.60	8.40	132.00
78		307.34	111.76	107.95	91.44	213.36	2163.09

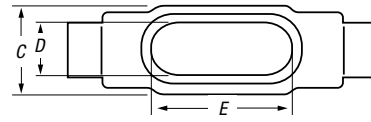

C Mark 9 Aluminum Conduit Bodies with Covers

CAT. NO.	HUB SIZE*	DIMENSIONS (IN. AND MM)**					VOL. CAP. (CU.IN./CU.CM)
		A	B	C	D	E	
C19-	½"	5.00	1.38	1.38	1.19	3.31	—
16		127.00	35.05	35.05	30.23	84.07	—
C29-	¾"	5.69	1.63	1.56	1.38	3.94	—
21		144.53	41.40	39.62	35.05	100.08	—
C39-	1"	6.59	1.88	1.75	1.50	4.56	—
27		167.39	47.75	44.45	38.10	115.82	—
C49-	1¼"	7.50	2.50	2.19	1.94	5.31	—
35		190.50	63.50	55.63	49.28	134.87	—
C59-	1½"	8.25	2.75	2.50	2.25	6.00	—
41		209.55	69.85	63.50	57.15	152.40	—
C69-	2"	10.50	3.44	3.19	2.88	8.06	—
53		266.70	87.38	81.03	73.15	204.72	—
C789-	2½"	15.63	4.44	5.00	4.25	10.88	—
63		397.00	112.78	127.00	107.95	276.35	—
C889-	3"	15.63	4.81	5.00	4.25	10.88	—
78		397.00	122.17	127.00	107.95	276.35	—
C989-	3½"	18.75	5.69	6.25	5.44	13.44	—
91		476.25	144.53	158.75	138.18	341.38	—
C1089-	4"	18.75	5.94	6.25	5.44	13.44	—
103		476.25	150.88	158.75	138.18	341.38	—

C Form 8 Ferrous Conduit Bodies with Covers

CAT. NO.	HUB SIZE*	DIMENSIONS (IN. AND MM)**					VOL. CAP. (CU.IN./CU.CM)
		A	B	C	D	E	
C18-4X-	½"	5.53	1.44	1.38	1.00	3.31	4.90
16		140.49	36.51	34.93	25.40	84.14	80.30
C28-4X-	¾"	6.28	1.53	1.19	1.19	3.94	8.00
21		159.54	38.89	30.16	30.16	100.01	131.10
C38-4X-	1"	7.31	1.94	1.75	1.38	4.56	13.00
27		185.74	49.21	44.45	34.93	115.89	213.03
C448-4X-	1¼"	8.50	2.38	2.19	1.75	5.31	23.50
35		215.90	60.33	55.56	44.45	134.94	385.10
C58-4X-	1½"	10.38	2.78	2.75	2.13	6.50	45.00
41		263.53	70.64	69.85	53.98	165.10	737.42
C68-4X-	2"	12.25	3.56	3.75	3.00	8.56	88.00
53		311.15	90.49	95.25	76.20	217.49	1442.06
C78-	2½"	15.63	4.44	5.00	4.25	10.88	110.00
63		396.88	112.71	127.00	107.95	276.23	1802.58
C88-	3"	15.63	4.81	5.00	4.25	10.88	110.00
78		396.88	122.24	127.00	107.95	276.23	1802.58

* Metric size designator (ANSI C80.1-1994).

** Dimensions shown are for uncoated conduit bodies.

C Form 7 Aluminum Conduit Bodies with Covers

CAT. NO.	HUB SIZE*	DIMENSIONS (IN. AND MM)**					VOL. CAP. (CU.IN./CU.CM)
		A	B	C	D	E	
C17SA-	½"	5.45	1.40	1.45	.95	3.20	4.00
16		138.43	35.56	36.83	24.13	81.28	65.55
C27SA-	¾"	6.05	1.60	1.65	1.15	3.80	6.60
21		153.67	40.64	41.91	29.21	96.52	108.15
C37SA-	1"	6.75	1.90	1.80	1.35	4.55	10.60
27		171.45	48.26	45.72	34.29	115.57	173.70
C47SA-	1¼"	7.30	2.30	2.20	1.80	5.00	18.80
35		185.42	58.42	55.88	45.72	127.00	308.08
C57SA-	1½"	8.60	2.60	2.45	2.05	5.45	26.40
41		218.44	66.04	62.23	52.07	138.43	432.62
C67SA-	2"	9.50	3.20	3.05	2.45	6.40	51.00
53		241.30	81.28	77.47	62.23	162.56	835.74
C77SA-	2½"	12.10	3.65	4.25	3.60	8.40	102.00
63		307.34	92.71	107.95	91.44	213.36	1671.48
C87SA-	3"	12.10	4.40	4.25	3.60	8.40	132.00
78		307.34	111.76	107.95	91.44	213.36	2163.09

PVC-Coated Conduit Bodies and Fittings

LB

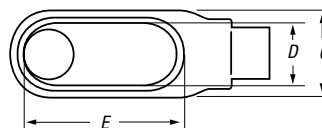
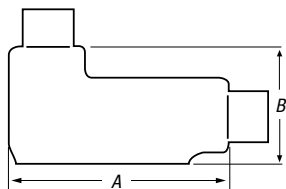

LB Form 7 Ferrous Conduit Bodies with Covers

CAT. NO.	HUB SIZE*	DIMENSIONS (IN. AND MM)**					VOL. CAP. (CU.IN./CU.CM)
		A	B	C	D	E	
LB17-	½"	4.60	2.20	1.35	.95	3.20	4.00
	16	116.84	55.88	34.29	24.13	81.28	65.55
LB27-	¾"	5.25	2.40	1.65	1.15	3.80	6.60
	21	133.35	60.96	41.91	29.21	96.52	108.15
LB37-	1"	6.00	2.65	1.80	1.35	4.55	10.60
	27	152.40	67.31	45.72	34.29	115.57	173.70
LB47-	1¼"	6.45	3.20	2.20	1.80	5.00	18.80
	35	163.83	81.28	55.88	45.72	127.00	308.08
LB57-	1½"	7.25	3.90	2.45	2.05	5.45	26.40
	41	184.15	99.06	62.23	52.07	138.43	432.62
LB67-	2"	8.30	4.45	3.10	2.45	6.40	51.00
	53	210.82	113.03	78.74	62.23	162.56	835.74
LB777-	2½"	10.55	5.20	4.25	3.60	8.40	102.00
	63	267.97	132.08	107.95	91.44	213.36	1671.48
LB87-	3"	10.55	5.95	4.25	3.60	8.40	132.00
	78	267.97	151.13	107.95	91.44	213.36	2163.09
LB97-	3½"	12.85	6.70	5.25	4.55	10.25	210.00
	91	326.39	170.18	133.35	115.57	260.35	3441.28
LB107-	4"	12.85	7.20	5.25	4.55	10.25	243.00
	103	326.39	182.88	133.35	115.57	260.35	3982.06

LB Mark 9 Aluminum Conduit Bodies with Covers

CAT. NO.	HUB SIZE*	DIMENSIONS (IN. AND MM)**					VOL. CAP. (CU.IN./CU.CM)
		A	B	C	D	E	
LB19-	½"	4.59	2.13	1.38	1.19	3.31	—
	16	116.68	53.98	34.93	30.16	84.14	—
LB29-	¾"	5.25	2.41	1.56	1.38	3.94	—
	21	133.35	61.12	39.69	34.93	100.01	—
LB39-	1"	6.09	2.84	1.75	1.50	4.56	—
	27	154.78	72.23	44.45	38.10	115.89	—
LB49-	1¼"	7.03	3.47	2.19	1.94	5.31	—
	35	178.59	88.11	55.56	49.21	134.94	—
LB59-	1½"	7.75	3.75	2.50	2.25	6.00	—
	41	196.85	95.25	63.50	57.15	152.40	—
LB69-	2"	10.03	4.47	3.19	2.88	8.06	—
	53	254.79	113.51	80.96	73.03	204.79	—
LB789-	2½"	13.94	6.13	5.00	4.25	10.88	—
	63	354.01	155.58	127.00	107.95	276.23	—
LB889-	3"	13.94	6.50	5.00	4.25	10.88	—
	78	354.01	165.10	127.00	107.95	276.23	—
LB989-	3½"	16.88	7.56	6.25	5.44	13.44	—
	91	428.63	192.09	158.75	138.11	341.31	—
LB1089-	4"	16.88	7.81	6.25	5.44	13.44	—
	103	428.63	198.44	158.75	138.11	341.31	—

LB Form 8 Ferrous Conduit Bodies with Covers

CAT. NO.	HUB SIZE*	DIMENSIONS (IN. AND MM)**					VOL. CAP. (CU.IN./CU.CM)
		A	B	C	D	E	
LB18-4X-	½"	4.94	2.22	1.38	1.00	3.31	4.90
	16	125.41	56.36	34.93	25.40	84.14	80.30
LB28-4X-	¾"	5.56	2.44	1.56	1.19	3.31	8.00
	21	141.29	61.93	39.69	30.16	84.14	131.10
LB38-4X-	1"	6.50	2.81	1.75	1.38	4.56	13.00
	27	165.10	71.45	44.45	34.93	115.89	213.03
LB448-4X-	1¼"	7.53	3.34	2.19	1.75	5.31	23.50
	35	191.29	84.93	55.56	44.45	134.94	385.10
LB58-4X-	1½"	9.13	4.03	2.75	2.13	6.50	45.00
	41	231.78	102.39	69.85	53.98	165.10	737.42
LB68-4X-	2"	11.00	4.41	3.75	3.00	8.56	88.00
	53	279.40	111.92	95.25	76.20	217.49	1442.06
LB78-	2½"	13.94	6.13	5.00	4.25	10.88	110.00
	63	354.01	155.58	127.00	107.95	276.23	1802.58
LB888-	3"	13.94	6.50	5.00	4.25	10.88	110.00
	78	354.01	165.10	127.00	107.95	276.23	1802.58
LB98-	3½"	16.88	7.56	6.25	5.44	13.44	250.00
	91	428.63	192.09	158.75	138.11	341.31	4096.77
LB108-	4"	16.88	7.81	6.25	5.44	13.44	250.00
	103	428.63	198.44	158.75	138.11	341.31	4096.77

LB Form 7 Aluminum Conduit Bodies with Covers

CAT. NO.	HUB SIZE*	DIMENSIONS (IN. AND MM)**					VOL. CAP. (CU.IN./CU.CM)
		A	B	C	D	E	
LB17SA-	½"	4.60	2.20	1.35	.95	3.20	4.00
	16	116.84	55.88	34.29	24.13	81.28	65.55
LB27SA-	¾"	5.25	2.40	1.65	1.15	3.80	6.60
	21	133.35	60.96	41.91	29.21	96.52	108.15
LB37SA-	1"	6.00	2.65	1.80	1.35	4.55	10.60
	27	152.40	67.31	45.72	34.29	115.57	173.70
LB47SA-	1¼"	6.45	3.20	2.20	1.80	5.00	18.80
	35	163.83	81.28	55.88	45.72	127.00	308.08
LB57SA-	1½"	7.25	3.90	2.45	2.05	5.45	26.40
	41	184.15	99.06	62.23	52.07	138.43	432.62
LB67SA-	2"	8.30	4.45	3.10	2.45	6.40	51.00
	53	210.82	113.03	78.74	62.23	162.56	835.74
LB777SA-	2½"	10.55	5.20	4.25	3.60	8.40	102.00
	63	267.97	132.08	107.95	91.44	213.36	1671.48
LB87SA-	3"	10.55	5.95	4.25	3.60	8.40	132.00
	78	267.97	151.13	107.95	91.44	213.36	2163.09
LB97SA-	3½"	12.85	6.70	5.25	4.55	10.25	210.00
	91	326.39	170.18	133.35	115.57	260.35	3441.28
LB107SA-	4"	12.85	7.20	5.25	4.55	10.25	243.00
	103	326.39	182.88	133.35	115.57	260.35	3982.06

* Metric size designator (ANSI C80.1-1994).

** Dimensions shown are for uncoated conduit bodies.

PVC-Coated Conduit Bodies and Fittings

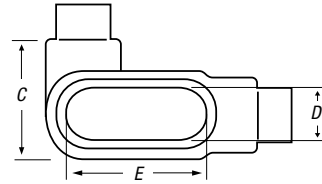
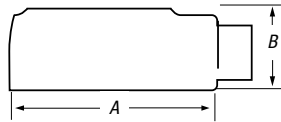

LL Form 7 Ferrous Conduit Bodies with Covers

CAT. NO.	HUB SIZE*	DIMENSIONS (IN. AND MM)**					VOL. CAP. (CU.IN./CU.CM)
		A	B	C	D	E	
LL17- 16	1/2"	4.60	1.40	1.45	.95	3.20	4.00
		116.84	35.56	36.83	24.13	81.28	65.55
LL27- 21	3/4"	5.25	1.60	1.65	1.15	3.80	6.60
		133.35	40.64	41.91	29.21	96.52	108.15
LL37- 27	1"	6.00	1.90	2.60	1.35	4.55	10.60
		152.40	48.26	66.04	34.29	115.57	173.70
LL47- 35	1 1/4"	6.45	2.30	3.05	1.80	5.00	18.60
		163.83	58.42	77.47	45.72	127.00	304.80
LL57- 41	1 1/2"	7.90	2.60	3.80	2.05	5.45	26.40
		200.66	66.04	96.52	52.07	138.43	432.62
LL67- 53	2"	8.30	3.20	4.25	2.45	6.40	51.00
		210.82	81.28	107.95	62.23	162.56	835.74
LL777- 63	2 1/2"	10.55	3.65	5.80	3.60	8.40	102.00
		267.97	92.71	147.32	91.44	213.36	1671.48
LL87- 78	3"	10.55	4.40	5.80	3.60	8.40	132.00
		267.97	111.76	147.32	91.44	213.36	2163.09
LL97- 91	3 1/2"	12.85	4.90	7.03	4.55	10.25	210.00
		326.39	124.46	178.56	115.57	260.35	3441.28
LL107- 103	4"	12.85	5.40	7.03	4.55	10.25	243.00
		326.39	137.16	178.56	115.57	260.35	3982.06

LL Mark 9 Aluminum Conduit Bodies with Covers

CAT. NO.	HUB SIZE*	DIMENSIONS (IN. AND MM)**					VOL. CAP. (CU.IN./CU.CM)
		A	B	C	D	E	
LL19- 16	1/2"	4.59	1.38	2.13	1.19	3.31	—
		116.68	34.93	53.98	30.16	84.14	—
LL29- 21	3/4"	5.25	1.63	2.38	1.38	3.94	—
		133.35	41.28	60.33	34.93	100.01	—
LL39- 27	1"	6.09	1.88	2.63	1.50	4.56	—
		154.78	47.63	66.68	38.10	115.89	—
LL49- 35	1 1/4"	7.03	2.50	3.09	1.94	5.31	—
		178.59	63.50	78.58	49.21	134.94	—
LL59- 41	1 1/2"	7.75	2.75	3.44	2.25	6.00	—
		196.85	69.85	87.31	57.15	152.40	—
LL69- 53	2"	10.03	3.44	4.13	2.88	8.06	—
		254.79	87.31	104.78	73.03	204.79	—
LL789- 63	2 1/2"	13.94	4.44	6.69	4.25	10.88	—
		354.01	112.71	169.86	107.95	276.23	—
LL889- 78	3"	13.94	4.81	6.69	4.25	10.88	—
		354.08	122.24	169.93	107.95	276.35	—
LL989- 91	3 1/2"	16.88	5.69	8.13	5.44	13.44	—
		428.63	144.46	206.38	138.11	341.31	—
LL1089- 103	4"	16.88	5.94	8.13	5.44	13.44	—
		428.63	150.81	206.38	138.11	341.31	—

LL Form 8 Ferrous Conduit Bodies with Covers

CAT. NO.	HUB SIZE*	DIMENSIONS (IN. AND MM)**					VOL. CAP. (CU.IN./CU.CM)
		A	B	C	D	E	
LL18-4X- 16	1/2"	4.94	1.44	2.16	1.00	3.31	4.90
		125.41	36.51	54.77	25.40	84.14	80.30
LL28-4X- 21	3/4"	5.56	1.69	2.31	1.19	3.94	8.00
		141.29	42.86	58.74	30.16	100.01	131.10
LL38-4X- 27	1"	6.47	1.94	2.63	1.38	4.56	13.00
		164.31	49.21	66.68	34.93	115.89	213.03
LL448-4X- 35	1 1/4"	7.53	2.38	3.16	1.75	5.31	23.50
		191.29	60.33	80.17	44.45	134.94	385.10
LL58-4X- 41	1 1/2"	9.13	2.78	4.00	2.13	6.50	45.00
		231.78	70.64	101.60	53.98	165.10	737.42
LL68-4X- 53	2"	11.00	3.56	5.00	3.00	8.56	88.00
		279.40	90.49	127.00	76.20	217.49	1442.06
LL78- 63	2 1/2"	13.94	4.44	6.69	4.25	10.88	110.00
		354.01	112.71	169.86	107.95	276.23	1802.58
LL888- 78	3"	13.94	4.81	6.69	4.25	10.88	110.00
		354.01	122.24	169.86	107.95	276.23	1802.58

* Metric size designator (ANSI C80.1-1994).
** Dimensions shown are for uncoated conduit bodies.

LL Form 7 Aluminum Conduit Bodies with Covers

CAT. NO.	HUB SIZE*	DIMENSIONS (IN. AND MM)**					VOL. CAP. (CU.IN./CU.CM)
		A	B	C	D	E	
LL17SA- 16	1/2"	4.60	1.40	1.45	.95	3.20	4.00
		116.84	35.56	36.83	24.13	81.28	65.55
LL27SA- 21	3/4"	5.25	1.60	1.65	1.15	3.80	6.60
		133.35	40.64	41.91	29.21	96.52	108.15
LL37SA- 27	1"	6.00	1.90	2.60	1.35	4.55	10.60
		152.40	48.26	66.04	34.29	115.57	173.70
LL47SA- 35	1 1/4"	6.45	2.30	3.05	1.80	5.00	18.60
		163.83	58.42	77.47	45.72	127.00	304.80
LL57SA- 41	1 1/2"	7.90	2.60	3.80	2.05	5.45	26.40
		200.66	66.04	96.52	52.07	138.43	432.62
LL67SA- 53	2"	8.30	3.20	4.25	2.45	6.40	51.00
		210.82	81.28	107.95	62.23	162.56	835.74
LL777SA- 63	2 1/2"	10.55	3.65	5.80	3.60	8.40	102.00
		267.97	92.71	147.32	91.44	213.36	1671.48
LL87SA- 78	3"	10.55	4.40	5.80	3.60	8.40	132.00
		267.97	111.76	147.32	91.44	213.36	2163.09
LL97SA- 91	3 1/2"	12.85	4.90	7.03	4.55	10.25	210.00
		326.39	124.46	178.56	115.57	260.35	3441.28
LL107SA- 103	4"	12.85	5.40	7.03	4.55	10.25	243.00
		326.39	137.16	178.56	115.57	260.35	3982.06

PVC-Coated Conduit Bodies and Fittings

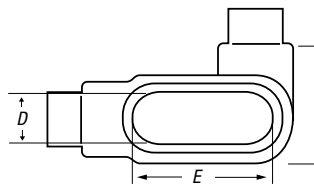
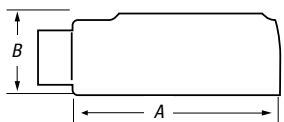

LR Form 7 Ferrous Conduit Bodies with Covers

CAT. NO.	HUB SIZE*	DIMENSIONS (IN. AND MM)**					VOL. CAP. (CU.IN./CU.CM)
		A	B	C	D	E	
LR17-	½"	4.60	1.40	1.45	.95	3.20	4.00
	16	116.84	35.56	36.83	24.13	81.28	65.55
LR27-	¾"	5.25	1.60	1.65	1.15	3.80	6.60
	21	133.35	40.64	41.91	29.21	96.52	108.15
LR37-	1"	6.00	1.90	2.60	1.35	4.55	10.60
	27	152.40	48.26	66.04	34.29	115.57	173.70
LR47-	1¼"	6.45	2.30	3.05	1.80	5.00	18.80
	35	163.83	58.42	77.47	45.72	127.00	308.08
LR57-	1½"	7.90	2.60	3.80	2.05	5.45	26.40
	41	200.66	66.04	96.52	52.07	138.43	432.62
LR67-	2"	8.30	3.20	4.25	2.45	6.40	51.00
	53	210.82	81.28	107.95	62.23	162.56	835.74
LR77-	2½"	10.55	3.65	5.80	3.60	8.40	102.00
	63	267.97	92.71	147.32	91.44	213.36	1671.48
LR87-	3"	10.55	4.40	5.80	3.60	8.40	132.00
	78	267.97	111.76	147.32	91.44	213.36	2163.09
LR97-	3½"	12.85	4.90	7.03	4.55	10.25	210.00
	91	326.39	124.46	178.56	115.57	260.35	3441.28
LR107-	4"	12.85	5.40	7.03	4.55	10.25	243.00
	103	326.39	137.16	178.56	115.57	260.35	3982.06

LR Mark 9 Aluminum Conduit Bodies with Covers

CAT. NO.	HUB SIZE*	DIMENSIONS (IN. AND MM)**					VOL. CAP. (CU.IN./CU.CM)
		A	B	C	D	E	
LR19-	½"	4.59	1.38	2.13	1.19	3.31	—
	16	116.68	34.93	53.98	30.16	84.14	—
LR29-	¾"	5.25	1.63	2.38	1.38	3.94	—
	21	133.35	41.28	60.33	34.93	100.01	—
LR39-	1"	6.09	1.88	2.63	1.50	4.56	—
	27	154.78	47.63	66.68	38.10	115.89	—
LR49-	1¼"	7.03	2.50	3.09	1.94	5.31	—
	35	178.59	63.50	78.58	49.21	134.94	—
LR59-	1½"	7.75	2.75	3.44	2.25	6.00	—
	41	196.85	69.85	87.31	57.15	152.40	—
LR69-	2"	10.03	3.44	4.13	2.88	8.06	—
	53	254.79	87.31	104.78	73.03	204.79	—
LR789-	2½"	13.94	4.44	6.69	4.25	10.88	—
	63	354.01	112.71	169.86	107.95	276.23	—
LR889-	3"	13.94	4.81	6.69	4.25	10.88	—
	78	354.08	122.24	169.93	107.95	276.35	—
LR989-	3½"	16.88	5.69	8.13	5.44	13.44	—
	91	428.63	144.46	206.38	138.11	341.31	—
LR1089-	4"	16.88	5.94	8.13	5.44	13.44	—
	103	428.63	150.81	206.38	138.11	341.31	—

LR Form 8 Ferrous Conduit Bodies with Covers

CAT. NO.	HUB SIZE*	DIMENSIONS (IN. AND MM)**					VOL. CAP. (CU.IN./CU.CM)
		A	B	C	D	E	
LR18-4X-	½"	4.94	1.44	2.16	1.00	3.31	4.90
	16	125.41	36.51	54.77	25.40	84.14	80.30
LR28-4X-	¾"	5.56	1.69	2.31	1.19	3.94	8.00
	21	141.29	42.86	58.74	30.16	100.01	131.10
LR38-4X-	1"	6.47	1.94	2.63	1.38	4.56	13.00
	27	164.31	49.21	66.68	34.93	115.89	213.03
LR448-4X-	1¼"	7.53	2.38	3.16	1.75	5.31	23.50
	35	191.29	60.33	80.17	44.45	134.94	385.10
LR58-4X-	1½"	9.13	2.78	4.00	2.13	6.50	45.00
	41	231.78	70.64	101.60	53.98	165.10	737.42
LR68-4X-	2"	11.00	3.56	5.00	3.00	8.56	88.00
	53	279.40	90.49	127.00	76.20	217.49	1442.06
LR78-	2½"	13.94	4.44	6.69	4.25	10.88	110.00
	63	354.01	112.71	169.86	107.95	276.23	1802.58
LR888-	3"	13.94	4.81	6.69	4.25	10.88	110.00
	78	354.01	122.24	169.86	107.95	276.23	1802.58

* Metric size designator (ANSI C80.1-1994).

** Dimensions shown are for uncoated conduit bodies.

LR Form 7 Aluminum Conduit Bodies with Covers

CAT. NO.	HUB SIZE*	DIMENSIONS (IN. AND MM)**					VOL. CAP. (CU.IN./CU.CM)
		A	B	C	D	E	
LR17SA-	½"	4.60	1.40	1.45	.95	3.20	4.00
	16	116.84	35.56	36.83	24.13	81.28	65.55
LR27SA-	¾"	5.25	1.60	1.65	1.15	3.80	6.60
	21	133.35	40.64	41.91	29.21	96.52	108.15
LR37SA-	1"	6.00	1.90	2.60	1.35	4.55	10.60
	27	152.40	48.26	66.04	34.29	115.57	173.70
LR47SA-	1¼"	6.45	2.30	3.05	1.80	5.00	18.80
	35	163.83	58.42	77.47	45.72	127.00	308.08
LR57SA-	1½"	7.90	2.60	3.80	2.05	5.45	26.40
	41	200.66	66.04	96.52	52.07	138.43	432.62
LR67SA-	2"	8.30	3.20	4.25	2.45	6.40	51.00
	53	210.82	81.28	107.95	62.23	162.56	835.74
LR777SA-	2½"	10.55	3.65	5.80	3.60	8.40	102.00
	63	267.97	92.71	147.32	91.44	213.36	1671.48
LR87SA-	3"	10.55	4.40	5.80	3.60	8.40	132.00
	78	267.97	111.76	147.32	91.44	213.36	2163.09
LR97SA-	3½"	12.85	4.90	7.03	4.55	10.25	210.00
	91	326.39	124.46	178.56	115.57	260.35	3441.28
LR107SA-	4"	12.85	5.40	7.03	4.55	10.25	243.00
	103	326.39	137.16	178.56	115.57	260.35	3982.06

PVC-Coated Conduit Bodies and Fittings

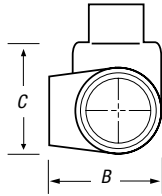

T Form 7 Ferrous Conduit Bodies with Covers

CAT. NO.	HUB SIZE*	DIMENSIONS (IN. AND MM)**					VOL. CAP. (CU.IN./CU.CM)
		A	B	C	D	E	
T17- 16	½"	5.60	1.80	2.35	.95	3.20	6.00
T27- 21	¾"	6.20	2.00	2.60	1.15	3.80	9.10
T37- 27	1"	7.35	2.30	3.10	1.35	4.55	16.90
T47- 35	1¼"	7.30	2.30	3.05	1.80	5.00	19.30
T57- 41	1½"	8.60	2.60	3.80	2.05	5.45	27.50
T67- 53	2"	9.50	3.20	4.25	2.45	6.40	50.00
T77- 63	2½"	12.10	3.65	5.80	3.60	8.40	102.00
T87- 78	3"	12.10	4.40	5.80	3.60	8.40	132.00
T97- 91	3½"	14.65	4.90	7.05	4.55	10.25	210.00
T107- 103	4"	14.65	5.40	7.05	4.55	10.25	243.00

T Form 8 Ferrous Conduit Bodies with Covers

CAT. NO.	HUB SIZE*	DIMENSIONS (IN. AND MM)**					VOL. CAP. (CU.IN./CU.CM)
		A	B	C	D	E	
T18-4X- 16	½"	5.69	1.75	2.16	1.00	3.31	6.00
T28-4X- 21	¾"	6.28	2.00	2.31	1.19	3.94	9.00
T38-4X- 27	1"	7.31	2.25	2.63	1.38	4.56	15.00
T448-4X- 35	1¼"	8.50	2.63	3.16	1.75	5.31	24.00
T58-4X- 41	1½"	10.38	2.78	4.00	2.13	6.50	46.50
T68-4X- 53	2"	12.25	3.56	5.00	3.00	8.56	88.00
T78- 63	2½"	15.63	4.44	6.69	4.25	10.88	110.00
T88- 78	3"	15.63	4.81	6.69	4.25	10.88	110.00

* Metric size designator (ANSI C80.1-1994).

** Dimensions shown are for uncoated conduit bodies.

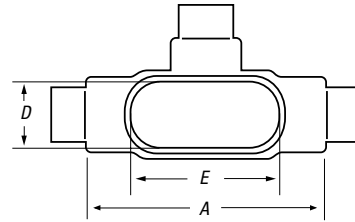

T Mark 9 Aluminum Conduit Bodies with Covers

CAT. NO.	HUB SIZE*	DIMENSIONS (IN. AND MM)**					VOL. CAP. (CU.IN./CU.CM)
		A	B	C	D	E	
T19- 16	½"	5.00	1.38	2.13	1.19	3.31	—
T29- 21	¾"	5.69	1.63	2.38	1.38	3.94	—
T39- 27	1"	6.59	1.88	2.63	1.50	4.56	—
T49- 35	1¼"	7.50	2.50	3.09	1.94	5.31	—
T59- 41	1½"	8.25	2.75	3.44	2.25	6.00	—
T69- 53	2"	10.50	3.44	4.13	2.88	8.06	—
T789- 63	2½"	15.63	4.44	6.69	4.25	10.88	—
T889- 78	3"	15.63	4.81	6.69	4.25	10.88	—
T989- 91	3½"	18.75	5.69	8.13	5.44	13.44	—
T1089- 103	4"	18.75	5.94	8.13	5.44	13.44	—

T Form 7 Aluminum Conduit Bodies with Covers

CAT. NO.	HUB SIZE*	DIMENSIONS (IN. AND MM)**					VOL. CAP. (CU.IN./CU.CM)
		A	B	C	D	E	
T17SA- 16	½"	5.60	1.80	2.35	.95	3.20	6.00
T27SA- 21	¾"	6.20	2.00	2.60	1.15	3.80	9.10
T37SA- 27	1"	7.35	2.30	3.10	1.35	4.55	16.90
T47SA- 35	1¼"	7.30	2.30	3.05	1.80	5.00	19.30
T57SA- 41	1½"	8.60	2.60	3.80	2.05	5.45	27.50
T67SA- 53	2"	9.50	3.20	4.25	2.45	6.40	50.00
T77SA- 63	2½"	12.10	3.65	5.80	3.60	8.40	102.00
T87SA- 78	3"	12.10	4.40	5.80	3.60	8.40	132.00
T97SA- 91	3½"	14.65	4.90	7.05	4.55	10.25	210.00
T107SA- 103	4"	14.65	5.40	7.05	4.55	10.25	243.00

PVC-Coated Conduit Bodies and Fittings

TB

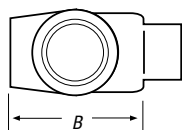

TB Form 7 Ferrous Conduit Bodies with Covers

CAT. NO.	HUB SIZE*	DIMENSIONS (IN. AND MM)**					VOL. CAP. (CU.IN./CU.CM)
		A	B	C	D	E	
TB17-	½"	5.60	2.06	1.63	.95	3.20	6.00
	16	142.24	52.32	41.40	24.13	81.28	98.32
TB27-	¾"	6.20	2.31	1.81	1.15	3.80	9.10
	21	157.48	58.67	45.97	29.21	96.52	149.12
TB37-	1"	7.35	2.50	2.31	1.35	4.55	16.90
	27	186.69	63.50	58.67	34.29	115.57	276.94
TB47-	1¼"	7.30	3.19	2.25	1.80	5.00	19.30
	35	185.42	81.03	57.15	45.72	127.00	316.27
TB57-	1½"	8.60	3.91	2.42	2.05	5.45	27.50
	41	218.44	99.31	61.47	52.07	138.43	450.64
TB67-	2"	9.50	4.50	3.06	2.45	6.40	52.80
	53	241.30	114.30	77.72	62.23	162.56	865.24

TB Form 8 Ferrous Conduit Bodies with Covers

CAT. NO.	HUB SIZE*	DIMENSIONS (IN. AND MM)**					VOL. CAP. (CU.IN./CU.CM)
		A	B	C	D	E	
TB18-4X-	½"	5.69	2.63	1.38	1.00	3.31	6.00
	16	144.46	66.68	34.93	25.40	84.14	98.32
TB28-4X-	¾"	6.28	2.88	1.19	1.19	3.94	9.00
	21	159.54	73.03	30.16	30.16	100.01	147.48
TB38-4X-	1"	7.31	3.25	1.75	1.38	4.56	15.00
	27	185.74	82.55	44.45	34.93	115.89	245.81
TB448-4X-	1¼"	8.50	3.31	2.19	1.75	5.31	24.00
	35	215.90	84.14	55.56	44.45	134.94	393.29
TB58-4X-	1½"	10.38	3.69	2.75	2.13	6.50	46.50
	41	263.53	93.66	69.85	53.98	165.10	762.00
TB68-4X-	2"	12.25	4.25	3.75	3.00	8.56	88.00
	53	311.15	107.95	95.25	76.20	217.49	1442.06

* Metric size designator (ANSI C80.1-1994).

** Dimensions shown are for uncoated conduit bodies.

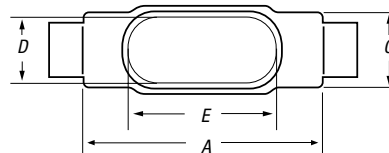

TB Mark 9 Aluminum Conduit Bodies with Covers

CAT. NO.	HUB SIZE*	DIMENSIONS (IN. AND MM)**					VOL. CAP. (CU.IN./CU.CM)
		A	B	C	D	E	
TB19-	½"	5.00	2.13	1.38	1.19	3.31	—
	16	127.00	53.98	34.93	30.16	84.14	—
TB29-	¾"	5.69	2.41	1.56	1.38	3.94	—
	21	144.46	61.12	39.69	34.93	100.01	—
TB39-	1"	6.59	2.84	1.75	1.50	4.56	—
	27	167.48	72.23	44.45	38.10	115.89	—
TB49-	1¼"	7.50	3.47	2.19	1.94	5.31	—
	35	190.50	88.11	55.56	49.21	134.94	—

TB Form 7 Aluminum Conduit Bodies with Covers

CAT. NO.	HUB SIZE*	DIMENSIONS (IN. AND MM)**					VOL. CAP. (CU.IN./CU.CM)
		A	B	C	D	E	
TB17SA-	½"	5.60	2.06	1.63	.95	3.20	6.00
	16	142.24	52.32	41.40	24.13	81.28	98.32
TB27SA-	¾"	6.20	2.31	1.81	1.15	3.80	9.10
	21	157.48	58.67	45.97	29.21	96.52	149.12
TB37SA-	1"	7.35	2.50	2.31	1.35	4.55	16.90
	27	186.69	63.50	58.67	34.29	115.57	276.94
TB47SA-	1¼"	7.30	3.19	2.25	1.80	5.00	19.30
	35	185.42	81.03	57.15	45.72	127.00	316.27
TB57SA-	1½"	8.60	3.91	2.42	2.05	5.45	27.50
	41	218.44	99.31	61.47	52.07	138.43	450.64
TB67SA-	2"	9.50	4.50	3.06	2.45	6.40	52.80
	53	241.30	114.30	77.72	62.23	162.56	865.24

LU

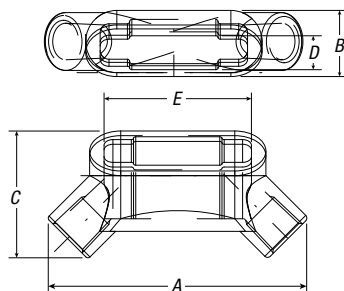

LU Form 7

LU Form 7 Ferrous Conduit Bodies with Covers

CAT. NO.	HUB SIZE	DIMENSIONS (IN.)					CU. IN.
		A	B	C	D	E	
LU17-	½"	5.54	1.45	2.72	.95	3.20	4.8
LU27-	¾"	6.22	1.70	3.07	1.15	3.80	7.6
LU37-	1"	7.34	1.97	3.52	1.35	4.55	13.4
LU47-	1¼"	8.40	2.47	4.21	1.80	5.00	23.0
LU57-	1½"	8.95	2.72	4.44	2.05	5.45	28.3
LU67-	2"	10.61	3.43	5.43	2.45	6.40	56.0

* Metric size designator (ANSI C80.1-1994).

** Dimensions shown are for uncoated conduit bodies.

PVC-Coated Conduit Bodies and Fittings

X

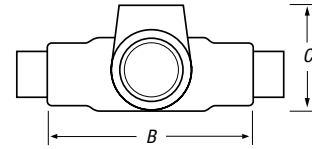
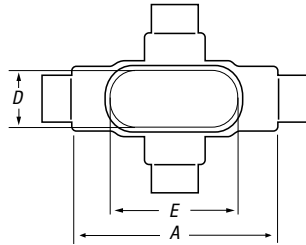

X Form 7 Ferrous Conduit Bodies with Covers

CAT. NO.	HUB SIZE*	DIMENSIONS (IN. AND MM)**					VOL. CAP. (CU.IN./CU.CM)
		A	B	C	D	E	
X17- ₋	½"	5.60	1.80	3.05	.95	3.20	6.00
	16	142.24	45.72	77.47	24.13	81.28	98.32
X27- ₋	¾"	6.20	2.00	3.30	1.15	3.80	9.10
	21	157.48	50.80	83.82	29.21	96.52	149.12
X37- ₋	1"	7.35	2.30	3.80	1.35	4.55	16.90
	27	186.69	58.42	96.52	34.29	115.57	276.94
X47- ₋	1¼"	7.30	2.30	3.85	1.80	5.00	19.30
	35	185.42	58.42	97.79	45.72	127.00	316.27
X57- ₋	1½"	8.60	2.60	5.05	2.05	5.45	27.50
	41	218.44	66.04	128.27	52.07	138.43	450.64
X67- ₋	2"	9.50	3.20	5.45	2.45	6.40	52.80
	53	241.30	81.28	138.43	62.23	162.56	865.24

X Form 8 Ferrous Conduit Bodies with Covers

CAT. NO.	HUB SIZE*	DIMENSIONS (IN. AND MM)**					VOL. CAP. (CU.IN./CU.CM)
		A	B	C	D	E	
X18-4X- ₋	½"	5.69	1.75	2.91	1.00	3.31	6.00
	16	144.46	44.45	73.82	25.40	84.14	98.32
X28-4X- ₋	¾"	6.28	2.00	3.06	1.38	3.94	9.00
	21	159.54	50.80	77.79	34.93	100.01	147.48
X38-4X- ₋	1"	7.31	2.25	3.50	1.38	4.56	15.00
	27	185.74	57.15	88.90	34.93	115.89	245.81
X448-4X- ₋	1¼"	8.50	2.63	4.13	1.75	5.31	24.00
	35	215.90	66.68	104.78	44.45	134.94	393.29
X58-4X- ₋	1½"	10.38	2.47	5.25	2.13	6.50	46.50
	41	263.53	62.71	133.35	53.98	165.10	762.00
X68-4X- ₋	2"	12.25	3.56	6.25	3.00	8.56	88.00
	53	311.15	90.49	158.75	76.20	217.49	1442.06

* Metric size designator (ANSI C80.1-1994). ** Dimensions shown are for uncoated conduit bodies.

X Mark 9 Aluminum Conduit Bodies with Covers

CAT. NO.	HUB SIZE*	DIMENSIONS (IN. AND MM)**					VOL. CAP. (CU.IN./CU.CM)
		A	B	C	D	E	
X19- ₋	½"	5.69	2.91	1.75	1.00	3.31	—
	16	144.46	73.82	44.45	25.40	84.14	—
X29- ₋	¾"	6.28	3.06	2.00	1.19	3.94	—
	21	159.54	77.79	50.80	30.16	100.01	—
X39- ₋	1"	7.31	3.50	2.25	1.38	4.56	—
	27	185.74	88.90	57.15	34.93	115.89	—

X Form 7 Aluminum Conduit Bodies with Covers

CAT. NO.	HUB SIZE*	DIMENSIONS (IN. AND MM)**					VOL. CAP. (CU.IN./CU.CM)
		A	B	C	D	E	
X17SA- ₋	½"	5.60	1.80	3.05	.95	3.20	6.00
	16	142.24	45.72	77.47	24.13	81.28	98.32
X27SA- ₋	¾"	6.20	2.00	3.30	1.15	3.80	9.10
	21	157.48	50.80	83.82	29.21	96.52	149.12
X37SA- ₋	1"	7.35	2.30	3.80	1.35	4.55	16.90
	27	186.69	58.42	96.52	34.29	115.57	276.94
X47SA- ₋	1¼"	7.30	2.30	3.85	1.80	5.00	19.30
	35	185.42	58.42	97.79	45.72	127.00	316.27
X57SA- ₋	1½"	8.60	2.60	5.05	2.05	5.45	27.50
	41	218.44	66.04	128.27	52.07	138.43	450.64
X67SA- ₋	2"	9.50	3.20	5.45	2.45	6.40	52.80
	53	241.30	81.28	138.43	62.23	162.56	865.24

PVC-Coated Conduit Bodies and Fittings

Make 90° bends while allowing straight pulls! Ocal-Blue® Double-Coat Pulling Elbows



LBD2200-G

LBD and LBH bodies are installed at 90° bends in rigid conduit to act as pull outlets for conductors that are stiff due to large size or type of insulation and to make 90° bends in conduit system while allowing straight wire pulls in either direction.

- Choose LBD series for ordinary locations and LBH series for hazardous locations
- Coated with a nominal .002" (2 mil) blue urethane on both interior and exterior
- Nominal .040" (40 mil) PVC coating bonded to exterior
- Pressure-sealing sleeves seal connections

CAT. NO.	COLOR
LBD1100- _____	
_ = space for color identifier	
G = Gray	
W = White	
B = Blue	
Custom colors also available.	

ORDINARY LBD SERIES CAT. NO.	HAZARDOUS LBH SERIES** CAT. NO.	PIPE SIZE IN. METRIC SIZE DESIGNATOR*
LBD1100-__	LBH10-__	1/2 16
LBD2200-__	LBH20-__	3/4 21
LBD3300-__	LBH30-__	1 27
LBD4400-__	LBH40-__	1 1/4 35
LBD5500-__	LBH50-__	1 1/2 41
LBD6600-__	LBH60-__	2 53
LBD7700-__	LBH70-__	2 1/2 63
LBD8800-__	LBH80-__	3 78
LBD9900-__	LBH90-__	3 1/2 91
LBD10900-__	LBH100-__	4 103
LBD012-__	—	5 129
LBD014-__	—	6 15

* Metric size designator (ANSI C80.1-1994).
** Ratings prior to PVC coating



BC3-G Mogul



BLB4-G Mogul



BUB3-G Mogul

Ocal-Blue® Double-Coat Mogul Fittings

Install mogul fittings in conduit systems to act as pull outlets for conductors that are stiff due to large size or type of installation, to provide the longer openings needed when pulling large conductors, to prevent sharp bends and kinks in large conductors or to provide more splicing space.

- Nominal .002" (2 mil) blue urethane on both interior and exterior
- Nominal .040" (40 mil) PVC coating bonded to exterior
- Pressure-sealing sleeves protect connections



BG48-G Replacement Cover

CAT. NO.	COLOR
BC3 - _____	
_ = space for color identifier	
G = Gray	
W = White	
B = Blue	
Custom colors also available.	

MOGUL FITTING WITH COVER AND GASKET				REPLACEMENT COVER BG	PIPE SIZE IN. METRIC SIZE DESIGNATOR*
BC CAT. NO.	BLB CAT. NO.	BUB CAT. NO.	BT CAT. NO.	CAT. NO.	
BC3-__	BLB3-__	BUB3-__	BT3-__	BG48-__	1 27
BC4-__	BLB4-__	BUB4-__	BT4-__	BG48-__	1 1/4 35
BC5-__	BLB5-__	BUB5-__	BT5-__	BG68-__	1 1/2 41
BC6-__	BLB6-__	BUB6-__	BT6-__	BG68-__	2 53
BC7-__	BLB7-__	BUB7-__	BT7-__	BG88-__	2 1/2 63
BC8-__	BLB8-__	BUB8-__	BT8-__	BG88-__	3 78
BC9-__	BLB9-__	BUB9-__	BT9-__	BG98-__	3 1/2 91
BC10-__	BLB10-__	BUB10-__	BT10-__	BG98-__	4 103

* Metric size designator (ANSI C80.1-1994).

PVC-Coated Conduit Bodies and Fittings

Make 90° bends in limited space! Ocal-Blue® Double-Coat Service Entrance Elbows

LBY Series elbows are installed in conduit systems to make 90° bends where space is limited, to act as pull outlets and to provide access to conductors for maintenance and future system changes.

- Nominal .002" (2 mil) blue urethane on both interior and exterior
- Nominal .040" (40 mil) PVC coating bonded to exterior
- Pressure-sealing sleeves protect connections



LBY25-G

CAT. NO.	PIPE SIZE IN. METRIC SIZE DESIGNATOR*
LBY15-__	½ 16
LBY25-__	¾ 21
LBY35-__	1 27
LBY45-__	1¼ 35
LBY55-__	1½ 41



LBY25-G

* Metric size designator (ANSI C80.1-1994).

CAT. NO.	COLOR
LBY15 - __	
__ = space for color identifier	
G = Gray	
W = White	
B = Blue	
Custom colors also available.	

End or change directions in conduit runs.

Ocal-Blue® Double-Coat Malleable Elbows

EL Series elbows are installed at the end of conduit runs, in a box or a fitting hub to change direction in threaded rigid conduit run by 45° or 90° or when terminating at a box or fitting.

- Nominal .002" (2 mil) blue urethane on both interior and exterior
- Nominal .040" (40 mil) PVC coating bonded to exterior
- Pressure-sealing sleeves protect connections



90° MALE CAT. NO.	90° FEMALE CAT. NO.	90° MALE-FEMALE CAT. NO.	45° FEMALE CAT. NO.	PIPE SIZE IN. METRIC SIZE DESIGNATOR*
EL195-__	EL19-__	EL196-__	EL1-__	½ 16
EL295-__	EL29-__	EL296-__	EL2-__	¾ 21
EL395-__	EL39-__	EL396-__	EL3-__	1 27
—	EL49-__	EL496-__	EL4-__	1¼ 35
—	EL59-__	—	EL5-__	1½ 41
—	EL69-__	—	EL6-__	2 53
—	EL79-__	—	EL7-__	2½ 63
—	—	—	EL8-__	3 78
—	—	—	EL9-__	3½ 91
—	—	—	EL10-__	4 103

* Metric size designator (ANSI C80.1-1994).

CAT. NO.	COLOR
EL195 - __	
__ = space for color identifier	
G = Gray	
W = White	
B = Blue	
Custom colors also available.	

PVC-Coated Conduit Bodies and Fittings

Unique sealing ring and groove design for optimum performance!

Ocal-Blue® Double-Coat and Stainless Steel Hubs

- Captive sealing ring won't buckle or slip during installation and provides a complete 360° seal — even when conduit isn't perpendicular to the enclosure
- Hexagonal/splined body and locknut enable fast and easy installation
- Insulated throat molded from 105° C-rated thermoplastic, UL94V0 flammability rated
- Sharper and deeper teeth provide a more penetrating bite for improved bonding to the enclosure
- Zinc or copper-free aluminum with a nominal .040" (40 mil) PVC coating bonded to exterior — in blue, white, gray or custom colors
- Pressure-sealing sleeves protect your connections
- Also available uncoated in 316-grade stainless steel



H050GRSST
Stainless Steel
Grounded Hub

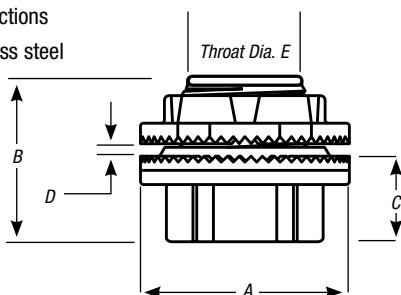

HUB1-1/4-G
PVC-Coated Zinc Hub

STG6-G
PVC-Coated Zinc Grounded Hub

CAT. NO.	COLOR
HUB1 - _____	
= space for color identifier	
G = Gray	
W = White	
B = Blue	
Custom colors also available.	

Knockout Hubs

PVC-COATED ZINC HUB	PVC-COATED ALUMINUM HUB	PVC-COATED ZINC GROUNDED HUB	316 STAINLESS GROUNDED HUB	PIPE SIZE		DIMENSIONS (UNCOATED HUB)									
				IN.	MM	A (OVERALL DIA.)		B		C		D (MAX. PANEL THICKNESS)		E (THROAT DIA.)	
CAT. NO.	CAT. NO.	CAT. NO.	CAT. NO.	IN.	MM	IN.	MM	IN.	MM	IN.	MM	IN.	MM	IN.	MM
HUB1/2-__	HUB1/2SA-__	STG1-__	H050GRSST	½	16	1.44	36.58	1.56	39.62	.88	22.35	.19	4.83	.59	14.99
HUB3/4-__	HUB3/4SA-__	STG2-__	H075GRSST	¾	21	1.44	36.58	1.59	40.39	.91	23.11	.19	4.83	.78	19.81
HUB1-__	HUB1SA-__	STG3-__	H100GRSST	1	27	2.00	50.80	1.81	45.97	1.06	26.92	.25	6.35	1.00	25.40
HUB1-1/4-__	HUB1-1/4SA-__	STG4-__	H125GRSST	1¼	35	2.38	60.45	1.88	47.75	1.06	26.92	.25	6.35	1.31	33.27
HUB1-1/2-__	HUB1-1/2SA-__	STG5-__	H150GRSST	1½	41	2.75	69.85	1.88	47.75	1.06	26.92	.25	6.35	1.53	38.86
HUB2-__	HUB2SA-__	STG6-__	H200GRSST	2	53	3.25	82.55	1.94	49.28	1.16	29.46	.25	6.35	1.97	50.04
HUB2-1/2-__	HUB2-1/2SA-__	STG7-__	—	2½	63	3.75	95.25	2.56	65.02	1.56	39.62	.25	6.35	2.41	61.21
HUB3-__	HUB3SA-__	STG8-__	—	3	78	4.38	111.25	2.44	61.98	1.59	40.39	.25	6.35	2.97	75.44
HUB3-1/2-__	HUB3-1/2SA-__	STG9-__	—	3½	91	5.00	127.00	2.72	69.09	1.63	41.40	.25	6.35	3.41	86.61
HUB4-__	HUB4SA-__	STG10-__	—	4	103	5.50	139.70	2.72	69.09	1.63	41.40	.25	6.35	3.88	98.55
HUB5-__	HUB5SA-__	STG11-__	—	5	129	6.88	174.75	3.03	76.96	1.94	49.28	.25	6.35	4.94	125.48
HUB6-__	HUB6SA-__	STG12-__	—	6	155	7.69	195.33	3.16	80.26	2.00	50.80	.31	7.87	6.00	152.40

T&B® Grounding and Bonding Locknuts for Hubs

- Available in zinc, copper-free aluminum or 316 stainless steel
- UL® File No. E-3060, CSA File No. 4484
- Use as replacement locknuts for the hubs featured above



ZINC	ALUMINUM	316 STAINLESS	PIPE SIZE		DIAMETER		HEIGHT		MAX. COND. SIZE	
			IN.	MM	IN.	MM	IN.	MM	AWG	SQ. MM
CAT. NO.	CAT. NO.	CAT. NO.	IN.	MM	IN.	MM	IN.	MM	GROUND SCREW	
L050GR-TB	L050GRA-TB	L050GRSST	½	16	1.50	38.10	.41	10.41	#10-32 x ¼"	#10 6
L075GR-TB	L075GRA-TB	L075GRSST	¾	21	1.69	42.93	.41	10.41	#10-32 x ¼"	#10 6
L100GR-TB	L100GRA-TB	L100GRSST	1	27	2.00	50.80	.41	10.41	#10-32 x ¼"	#10 6
L125GR-TB	L125GRA-TB	L125GRSST	1¼	35	2.38	60.45	.47	11.94	¼-20 x ¼"	#10 6
L150GR-TB	L150GRA-TB	L150GRSST	1½	41	2.75	69.85	.47	11.94	¼-20 x ⅝"	#8 10
L200GR-TB	L200GRA-TB	L200GRSST	2	53	3.25	82.55	.47	11.94	¼-20 x ⅝"	#8 10
L250GR-TB	L250GRA-TB	—	2½	63	3.75	95.25	.69	17.53	¼-20 x ⅝"	#6 16
L300GR-TB	L300GRA-TB	—	3	78	4.38	111.25	.72	18.29	¼-20 x ⅝"	#6 16
L350GR-TB	L350GRA-TB	—	3½	91	5.00	127.00	.72	18.29	¼-20 x ⅝"	#6 16
L400GR-TB	L400GRA-TB	—	4	103	5.50	139.70	.72	18.29	¼-20 x ⅝"	#4 25
L500GR-TB	L500GRA-TB	—	5	129	6.63	168.40	.72	18.29	⅜-16 x ⅝"	#2 35
L600GR-TB	L600GRA-TB	—	6	155	7.69	195.33	.72	18.29	⅜-16 x ⅝"	#1 50

* Metric size designator (ANSI C80.1-1994).

PVC-Coated Conduit Bodies and Fittings

In bulkhead and through-bulkhead styles!

Ocal® PVC-Coated Bulkhead Fittings



STTB2-G
Bulkhead Fitting

STTTB2-G
Through-Bulkhead
Fitting

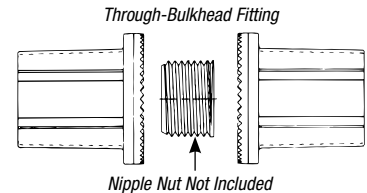
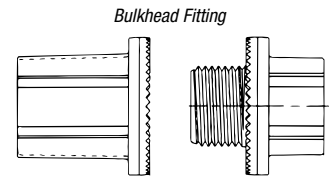
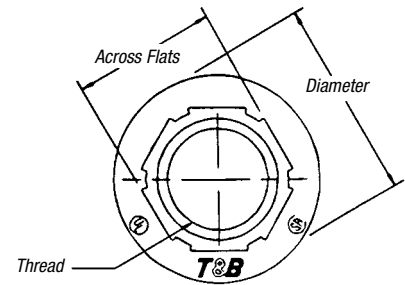
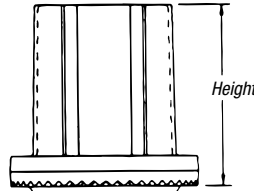
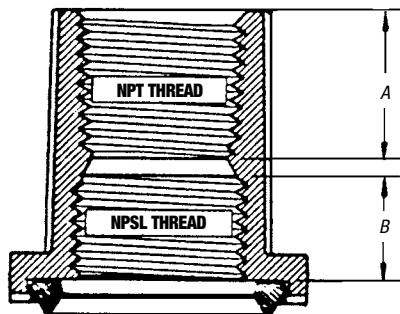

- Zinc body and locknut with thermoplastic insulating throat and nitrile sealing ring
- Nominal .040" (40 mil) PVC coating bonded to exterior — in blue, white, gray or custom colors
- Pressure-sealing sleeves protect your connections

CAT. NO.	COLOR
STTB1-__	
__ = space for color identifier	
G = Gray	
W = White	
B = Blue	
Custom colors also available.	

BULKHEAD FITTING CAT. NO.	THROUGH-BULKHEAD FITTING CAT. NO.	PIPE SIZE IN. METRIC SIZE DESIGNATOR*	THREAD	HEIGHT IN. MM	DIA. IN. MM	ACROSS FLATS IN. MM	"A" IN. MM	"B" IN. MM
STTB1-__	STTTB1-__	½	½-14	1.41	1.44	1.00	.75	.50
		16	—	35.72	36.51	25.40	19.05	12.70
STTB2-__	STTTB2-__	¾	¾-14	1.47	1.69	1.25	.78	.53
		21	—	37.31	42.86	31.75	19.84	13.49
STTB3-__	STTTB3-__	1	1-11½	1.69	2.00	1.53	.91	.59
		27	—	42.86	50.80	38.89	23.02	15.08
STTB4-__	STTTB4-__	1¼	1¼-11½	1.78	2.38	1.84	.91	.66
		35	—	45.24	60.33	46.83	23.02	16.67
STTB5-__	STTTB5-__	1½	1½-11½	1.81	2.75	1.13	.91	.66
		41	—	46.04	69.85	28.58	23.02	16.67
STTB6-__	STTTB6-__	2	2-11½	1.84	3.25	2.63	.94	.66
		53	—	46.83	82.55	66.68	23.81	16.67
STTB7-__	—	2½	2½-8	2.28	3.75	3.13	1.22	.88
		63	—	57.94	95.25	79.38	30.96	22.23
STTB8-__	—	3	3-8	2.56	4.38	3.78	1.19	.91
		78	—	65.09	111.13	96.04	30.16	23.02
STTB9-__	—	3½	3½-8	2.56	5.00	4.28	1.38	.88
		91	—	65.09	127.00	108.74	34.93	22.23
STTB10-__	—	4	4-8	2.56	5.50	4.84	1.38	.88
		103	—	65.09	139.70	123.03	34.93	22.23
STTB11-__	—	5	5-8	2.72	6.63	5.91	1.47	.88
		129	—	69.06	168.28	150.02	37.31	22.23
STTB12-__	—	6	6-8	3.00	7.69	7.03	1.50	.97
		155	—	76.20	195.26	178.58	38.10	24.61

* Metric size designator (ANSI C80.1-1994).
Dimensions shown are for uncoated fittings.

PVC-Coated Conduit Bodies and Fittings

Easily join two different sizes of conduit!

Ocal-Blue® Double-Coat Reducing Couplings

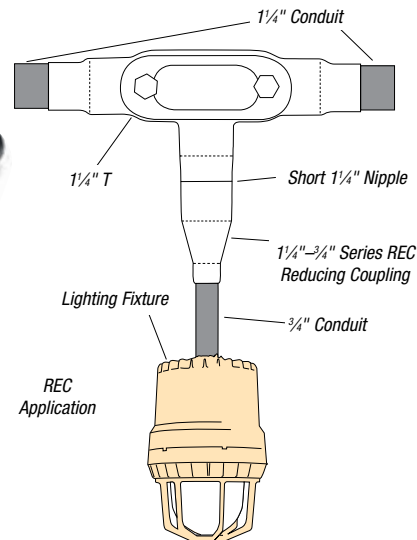

- Integral bushings in both ends prevent damage to wires
- Funnel-shaped interior guides wires from large to small conduit, making them easier to pull
- Nominal .002" (2 mil) blue urethane coating on both interior and exterior
- Nominal .040" (40 mil) PVC coating bonded to exterior
- Pressure-sealing sleeves protect connections



CAT. NO.	PIPE SIZE IN. METRIC SIZE DESIGNATOR*	
	A	B
REC21- <u> </u>	3/4	1/2
	21	16
REC31- <u> </u>	1	1/2
	27	16
REC32- <u> </u>	1	3/4
	27	21
REC42- <u> </u>	1 1/4	3/4
	35	21
REC43- <u> </u>	1 1/4	1
	35	27
REC52- <u> </u>	1 1/2	3/4
	41	21
REC53- <u> </u>	1 1/2	1
	41	27
REC54- <u> </u>	1 1/2	1 1/4
	41	35
REC602- <u> </u>	2	3/4
	53	21

CAT. NO.	PIPE SIZE IN. METRIC SIZE DESIGNATOR*	
	A	B
REC603- <u> </u>	2	1
	53	27
REC604- <u> </u>	2	1 1/4
	53	35
REC605- <u> </u>	2	1 1/2
	53	41
REC75- <u> </u>	2 1/2	1 1/2
	63	41
REC86- <u> </u>	3	2
	78	53
REC97- <u> </u>	3 1/2	2 1/2
	91	63
REC108- <u> </u>	4	3
	103	78
REC01210- <u> </u>	5	4
	129	103

* Metric size designator (ANSI C80.1-1994).

CAT. NO.	COLOR
REC21-<u> </u>	
<u> </u>	= space for color identifier
G	= Gray 
W	= White 
B	= Blue 
Custom colors also available.	

Reduce a conduit hub to a smaller size.

Ocal-Blue® Urethane-Coated Reducing Bushings

CAT. NO.	PIPE SIZE IN. METRIC SIZE DESIGNATOR*	
	A - MALE	B - FEMALE
RE21-G	3/4	1/2
	21	16
RE31-G	1	1/2
	27	16
RE32-G	1	3/4
	27	21
RE41-G	1 1/4	1/2
	35	16
RE42-G	1 1/4	3/4
	35	21
RE43-G	1 1/4	1
	35	21
RE51-G	1 1/2	1/2
	41	16
RE52-G	1 1/2	3/4
	41	21

CAT. NO.	PIPE SIZE IN. METRIC SIZE DESIGNATOR*	
	A - MALE	B - FEMALE
RE53-G	1 1/2	1
	41	27
RE54-G	1 1/2	1 1/4
	41	35
RE61-G	2	1/2
	53	16
RE62-G	2	3/4
	53	21
RE63-G	2	1
	53	27
RE64-G	2	1 1/4
	53	35
RE65-G	2	1 1/2
	53	41
RE73-G	2 1/2	1
	63	27

CAT. NO.	PIPE SIZE IN. METRIC SIZE DESIGNATOR*	
	A - MALE	B - FEMALE
RE74-G	2 1/2	1 1/4
	63	35
RE75-G	2 1/2	1 1/2
	63	41
RE76-G	2 1/2	2
	63	53
RE83-G	3	1
	78	27
RE84-G	3	1 1/4
	78	35
RE85-G	3	1 1/2
	78	41
RE86-G	3	2
	78	53
RE87-G	3	2 1/2
	78	63



CAT. NO.	PIPE SIZE IN. METRIC SIZE DESIGNATOR*	
	A - MALE	B - FEMALE
RE96-G	3 1/2	2
	91	53
RE97-G	3 1/2	2 1/2
	91	63
RE98-G	3 1/2	3
	91	78
RE106-G	4	2
	103	53
RE107-G	4	2 1/2
	103	63
RE108-G	4	3
	103	78

* Metric size designator (ANSI C80.1-1994).

PVC-Coated Conduit Bodies and Fittings



8" Movement
Coupling shown uncoated

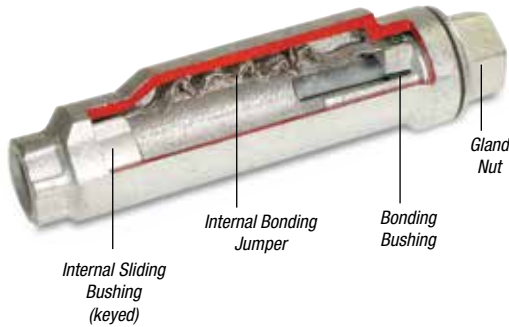

Coupling shown uncoated

Innovative Design Makes Installations Easier.

- No disassembly necessary to install
- Fast, simple and requires fewer steps
- True internal bonding jumper — no external grounding strap required
- Tamper-proof internal jumper protected from the environment
- Exceeds code requirements for long conduit runs to permit linear movement

No disassembly required.

Ocal® PVC-Coated XJG Rigid Conduit Expansion Coupling

When you install a rigid expansion coupling in a long conduit run, you normally need three hands, two strong backs and lots of patience. Now you can relax.

With the no-hassle XJG Rigid Conduit Expansion Coupling, installation's just a few turns and you're done.

The XJG Rigid Conduit Expansion Coupling features innovations that provide convenience to the installer, saving time and money on the job. No disassembly is needed during installation, requiring fewer tools and less opportunity for lost pieces. It also features a true internal bonding jumper, eliminating the need for external jumpers, so there are fewer parts to buy and install.

If you need a fitting that can give and take without a lot of hassle, reach for the XJG Rigid Conduit Expansion Coupling. It's the latest breakthrough in the industry's leading line of conduit fittings.



1

Slide the fitting onto the conduit until it stops at the internal sliding bushing. Tighten and you're ready. No parts to reassemble!



2

With a wrench, tighten the gland nut to create a raintight seal around the conduit.



3

Thread the next length of conduit into the other end of the fitting and tighten. You're done!

PVC-Coated Conduit Bodies and Fittings

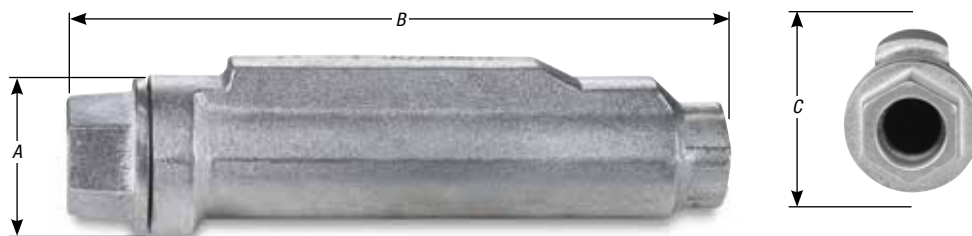

Coupling shown uncoated

PVC-Coated XJG Rigid Conduit Expansion Couplings

CAT. NO.	PIPE SIZE IN. METRIC SIZE DESIGNATOR*	MOVEMENT IN. MM	A DIAMETER IN. MM	B LENGTH IN. MM	C HEIGHT IN. MM
XJG24- 21	¾ 21	4.00 101.60	2.43 61.72	10.00 254.00	2.75 69.85
XJG28- 21	¾ 21	8.00 203.20	2.43 61.72	14.00 355.60	2.75 69.85
XJG34- 27	1 27	4.00 101.60	2.67 67.82	10.00 254.00	2.99 75.95
XJG38- 27	1 27	8.00 203.20	2.67 67.82	14.00 355.60	2.99 75.95
XJG44- 35	1¼ 35	4.00 101.60	3.36 85.34	10.56 268.22	3.68 93.47
XJG48- 35	1¼ 35	8.00 203.20	3.36 85.34	14.56 369.82	3.68 93.47
XJG54- 41	1½ 41	4.00 101.60	3.36 85.34	10.56 268.22	3.68 93.47
XJG58- 41	1½ 41	8.00 203.20	3.36 85.34	14.56 369.82	3.68 93.47
XJG64- 53	2 53	4.00 101.60	3.86 98.04	11.25 285.75	4.18 106.17
XJG68- 53	2 53	8.00 203.20	3.86 98.04	15.25 387.35	4.18 106.17
XJG74- 63	2½ 63	4.00 101.60	4.96 125.98	12.12 307.85	5.25 133.35
XJG78- 63	2½ 63	8.00 203.20	4.96 125.98	16.12 409.45	5.25 133.35
XJG84- 78	3 78	4.00 101.60	4.96 125.98	12.12 307.85	5.25 133.35
XJG88- 78	3 78	8.00 203.20	4.96 125.98	16.12 409.45	5.25 133.35
XJG94- 91	3½ 91	4.00 101.60	6.37 161.80	12.87 326.90	6.75 171.45
XJG98- 91	3½ 91	8.00 203.20	6.37 161.80	16.87 428.50	6.75 171.45
XJG104- 103	4 103	4.00 101.60	6.37 161.80	12.87 326.90	6.75 171.45
XJG108- 103	4 103	8.00 203.20	6.37 161.80	16.87 428.50	6.75 171.45
XJG1208- 129	5 129	8.00 203.20	7.99 161.80	18.87 479.30	8.56 217.42



* Metric size designator (ANSI C80.1 - 1994).
Dimensions shown are for uncoated coupling.



XJG24-G
4" Movement

Standard Materials/Finish

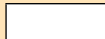
- Body/Finish: Ductile iron with nominal 40-mil PVC exterior coating
- Internal Bonding Jumper: Tinned copper braid

CAT. NO.	COLOR
XJG24- _	
_	= space for color identifier
G	= Gray 
W	= White 
B	= Blue 
Custom colors also available.	

PVC-Coated Conduit Bodies and Fittings

The ultimate liquidtight solution for corrosive environments!

Ocal® PVC-Coated Liquidtight Conduit Connectors



ST3/490-G
90° Angled



ST3/4-G
Straight



ST3/445-G
45° Angled

Non-Grounding Connectors

PVC-COATED STEEL STRAIGHT CAT. NO.	PVC-COATED ALUMINUM STRAIGHT CAT. NO.	PVC-COATED STEEL 45° CAT. NO.	PVC-COATED STEEL 90° CAT. NO.	PVC-COATED ALUMINUM 90° CAT. NO.	PIPE SIZE	
					IN.	METRIC DESIGNATOR*
ST3/8-	ST3/8SA-	ST3/845-	ST3/890-	ST3/890SA-	3/8	12
ST1/2-	ST1/2SA-	ST1/245-	ST1/290-	ST1/290SA-	1/2	16
ST3/4-	ST3/4SA-	ST3/445-	ST3/490-	ST3/490SA-	3/4	21
ST1-	ST1SA-	ST145-	ST190-	ST190SA-	1	27
ST1-1/4-	ST1-1/4SA-	ST1-1/445-	ST1-1/490-	ST1-1/490SA-	1 1/4	35
ST1-1/2-	ST1-1/2SA-	ST1-1/245-	ST1-1/290-	ST1-1/290SA-	1 1/2	41
ST2-	ST2SA-	ST245-	ST290-	ST290SA-	2	53
ST2-1/2-	ST2-1/2SA-	ST2-1/245-	ST2-1/290-	ST2-1/290SA-	2 1/2	63
ST3-	ST3SA-	ST345-	ST390-	ST390SA-	3	78
ST4-	ST4SA-	ST445-	ST490-	ST490SA-	4	103

* Metric size designator (ANSI C80.1-1994).

- Nominal .040" (40 mil) PVC coating bonded to exterior — available in gray, white, blue or custom colors
- Pressure-sealing sleeves protect the connection
- Ocal® uses only genuine T&B® liquidtight fittings to ensure quality installations
- Ground ring meets UL 467 for grounding and bonding
- Ground ring made with naval brass



ST3/490GR-G
90° Angled



ST3/4GR-G
Straight



ST3/445GR-G
45° Angled

Connectors with Grounding Ring



PVC-COATED STEEL STRAIGHT CAT. NO.	PVC-COATED STEEL 45° CAT. NO.	PVC-COATED STEEL 90° CAT. NO.	PIPE SIZE	
			IN.	METRIC DESIGNATOR*
ST1/2GR-	ST1/245GR-	ST1/290GR-	1/2	16
ST3/4GR-	ST3/445GR-	ST3/490GR-	3/4	21
ST1GR-	ST145GR-	ST190GR-	1	27
ST1-1/4GR-	ST1-1/445GR-	ST1-1/490GR-	1 1/4	35
ST1-1/2GR-	ST1-1/245GR-	ST1-1/290GR-	1 1/2	41
ST2GR-	ST245GR-	ST290GR-	2	53
ST2-1/2GR-	ST2-1/245GR-	ST2-1/290GR-	2 1/2	63
ST3GR-	ST345GR-	ST390GR-	3	78
ST4GR-	ST445GR-	ST490GR-	4	103

* Metric size designator (ANSI C80.1-1994).

CAT. NO.	MATERIAL	COLOR
ST3/4 -		
	Blank = Steel/Iron	G = Gray
	SA = Aluminum	W = White
	GR in Cat. No. designates ground ring.	B = Blue
	Custom colors also available.	

PVC-Coated Conduit Bodies and Fittings

The ideal fitting for jacketed metal-clad cable in ordinary locations!

Ocal-Blue® Double-Coat STAR TECK EXTREME® STE Series Fittings for Ordinary Locations

- Provides a means for passing armored and metal-clad jacketed cables through a bulkhead or enclosure
- Forms a mechanical grip and water- and/or oil-resistant termination
- Provides grounding continuity of cable armor
- Removable armor stop accommodates a wide range of cable sizes
- Features built-in sealing device and jacket stripping gauge, elastomeric collar ring/bushing and grounding ring
- Aluminum construction
- Nominal .002" (2 mil) blue urethane coating on both interior and exterior
- Nominal .040" (40 mil) PVC coating bonded to exterior

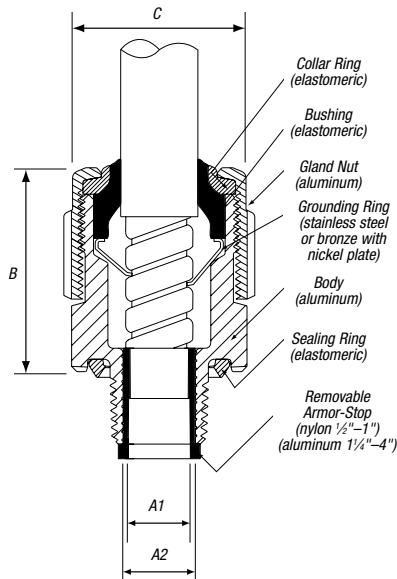

CAT. NO.	COLOR
STE050 -	_____
	_____ = space for color identifier
	G = Gray
	W = White
	B = Blue
	Custom colors also available.



PVC-Coated STE Series Fittings for Ordinary Locations

CAT. NO.	HUB SIZE IN. METRIC SIZE DESIGNATOR**	STRIP LENGTH IN. MM	GLAND TORQUE LB.-IN. NM	RANGE OVER JACKET		RANGE OVER ARMOR		A1: THROAT DIA. MIN. W/END STOP IN. MM	A2: THROAT DIA. MIN. W/O END STOP IN. MM	B OVERALL HEIGHT IN. MM	C MAX. WIDTH IN. MM
				MIN. IN. MM	MAX. IN. MM	MIN. IN. MM	MAX. IN. MM				
ST050-462-*	1/2	1.25	300	.53	.65	.42	.57	N/A***	.40	2.02	1.22
	16	31.75	33.90	13.46	16.51	10.67	14.48	N/A***	10.16	51.31	30.99
STE050-*	1/2	1.25	300	.60	.99	.52	.90	.51	.61	2.65	1.63
	16	31.75	33.90	15.24	25.15	13.21	22.86	12.95	15.49	67.31	41.40
STE075-*	3/4	1.25	600	.86	1.21	.78	1.13	.66	.82	2.90	2.08
	21	31.75	67.79	21.84	30.73	19.81	28.70	16.76	20.83	73.66	52.83
STE100-*	1	1.25	700	.95	1.38	.87	1.30	.79	1.04	3.02	2.30
	27	31.75	79.09	24.13	35.05	22.10	33.02	20.07	26.42	76.71	58.42
STE125-*	1 1/4	1.25	1000	1.15	1.63	.99	1.47	.97	1.25	4.01	2.82
	35	31.75	112.98	29.21	41.40	25.15	37.34	24.64	31.75	101.85	71.63
STE150-*	1 1/2	1.75	1200	1.44	1.97	1.28	1.81	1.26	1.56	4.29	3.25
	41	44.45	135.58	36.58	50.04	32.51	45.97	32.00	39.62	108.97	82.55
STE200-*	2	1.75	1600	1.83	2.38	1.67	2.22	1.65	2.00	4.12	3.60
	53	44.45	180.78	46.48	60.45	42.42	56.39	41.91	50.80	104.65	91.44
STE250-	2 1/2	2.50	1600	2.27	2.81	2.11	2.68	2.08	2.42	5.32	4.75
	63	63.50	180.78	57.66	71.37	53.59	68.07	52.83	61.47	135.13	120.65
STE300-	3	2.50	1600	2.67	3.27	2.55	3.15	2.53	2.89	5.40	5.40
	78	63.50	180.78	67.82	83.06	64.77	80.01	64.26	73.41	137.16	137.16
STE350-	3 1/2	2.50	1600	3.22	3.87	3.09	3.64	3.07	3.46	5.36	5.90
	91	63.50	180.78	81.79	98.30	78.49	92.46	77.98	87.88	136.14	149.86
STE400-	4	2.50	1600	3.67	4.34	3.55	4.23	3.53	3.94	5.42	6.40
	103	63.50	180.78	93.22	110.27	90.17	107.44	89.66	100.08	137.67	162.56

*These products are UL® Listed UL84H3 and watertight NEMA Type 6P.

**Metric size designator (ANSI C80.1-1994).

***This fitting does not have a removable armor stop.

PVC-Coated Boxes and Covers

Variety of styles offers versatility!

Ocal-Blue® Double-Coat FS and FD Series Device Boxes

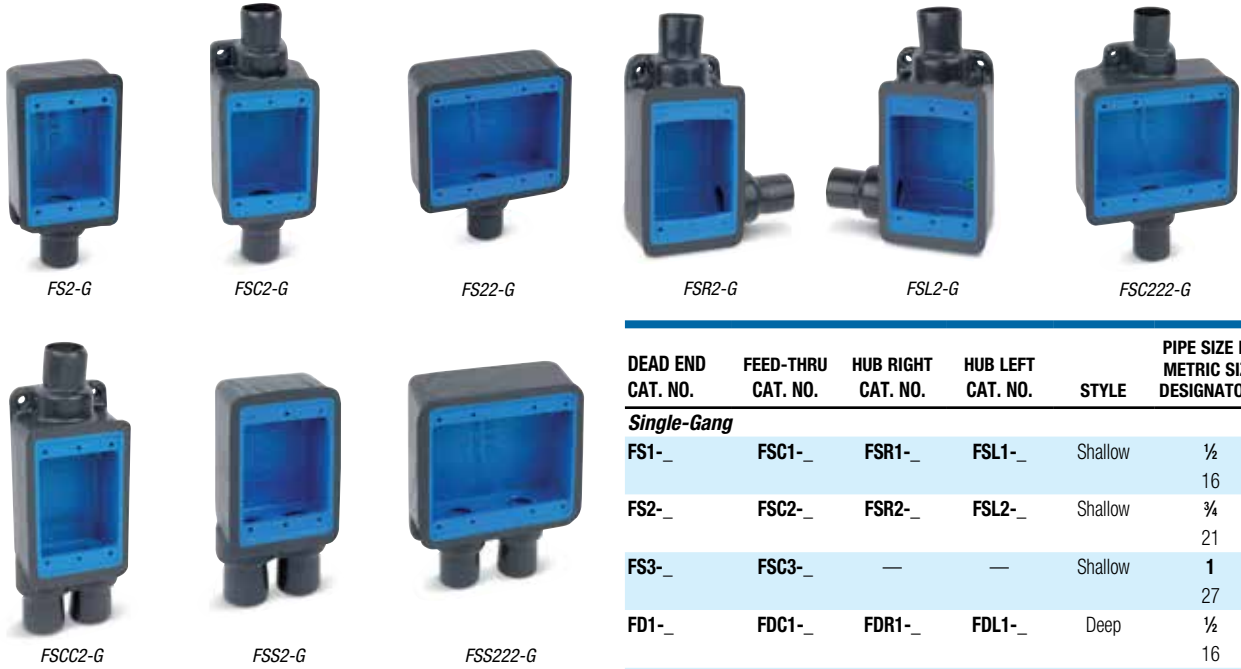

Install these boxes in conduit systems to accommodate wiring devices, act as pull boxes for conductors, provide openings to make splices and taps and provide access to conductors for maintenance and future system changes.

- Cast class 30 gray iron alloy boxes
- Coated with a nominal .002" (2 mil) blue urethane on both the interior and exterior before PVC coating is applied
- Nominal .040" (40 mil) PVC coating bonded to exterior
- PVC coating available in your choice of blue, white or gray with custom colors available on request
- Pressure-sealing sleeves protect connections with conduit

CAT. NO.	COLOR
FS1-	_____
	__ = space for color identifier
	G = Gray
	W = White
	B = Blue
	Custom colors also available.

DEAD END CAT. NO.	FEED-THRU CAT. NO.	HUB RIGHT CAT. NO.	HUB LEFT CAT. NO.	STYLE	PIPE SIZE IN. METRIC SIZE DESIGNATOR*
Single-Gang					
FS1-__	FSC1-__	FSR1-__	FSL1-__	Shallow	½ 16
FS2-__	FSC2-__	FSR2-__	FSL2-__	Shallow	¾ 21
FS3-__	FSC3-__	—	—	Shallow	1 27
FD1-__	FDC1-__	FDR1-__	FDL1-__	Deep	½ 16
FD2-__	FDC2-__	FDR2-__	FDL2-__	Deep	¾ 21
FD3-__	FDC3-__	—	—	Deep	1 27
—	FSCC2-__	—	—	Shallow	¾ 21
—	FDC2-__	—	—	Deep	¾ 21
FSS2-__	—	—	—	Shallow	¾ 21
FDD2-__	—	—	—	Deep	¾ 21
Double-Gang					
FS22-__	—	—	—	Shallow	¾ 21
FD22-__	—	—	—	Deep	¾ 21
FSS222-__	—	—	—	Shallow	¾ 21
FDS222-__	—	—	—	Deep	¾ 21
—	FSC222-__	—	—	Shallow	¾ 21
—	FDC222-__	—	—	Deep	¾ 21

* Metric size designator (ANSI C80.1-1994).

PVC-Coated Boxes and Covers

Designed for use with Ocal® FS and FD Series Boxes.

Ocal-Blue® Double-Coat FS and FD Series Covers



DS23-G



DS21G-G



DS32G-G



DS100G-G



DS185-G



FSK1VDR-G



FSKWGF1-G



WLGFSS-G



WLRD1-G



S1002G-G



S322G-G



S232-G



DS1282-G



S232GFI-G

CAT. NO.	DESCRIPTION	MATERIAL
Single-Gang		
DS23-	Duplex Receptacle Cover	Steel
DS21G-	Round Flush Receptacle Cover	Iron
DS32G-	Toggle Switch Cover	Iron
DS100G-	Blank Cover	Aluminum
Single-Gang — NEMA 3R Raintight when used with appropriate Ocal® boxes		
WLRD1-	Duplex Receptacle Cover – Box Mount – Horizontal	Aluminum
FSK1VDR-	Duplex Receptacle Cover – Box Mount – Vertical	Aluminum
WLGFSS-	GFCI Receptacle Cover – Box Mount – Horizontal	Aluminum
FSKWGF1-	GFCI Receptacle Cover – Box Mount – Vertical	Aluminum
DS185-	Front Lever Switch Cover – Box Mount – NEMA 4	Aluminum
Double-Gang		
S1002G-	Blank Cover	Iron
S322G-	2-Toggle Switch Cover	Iron
S232-	2-Duplex Receptacle Cover	Stamped Steel
S232GFI-	2-GFCI Receptacle Cover	Steel
Double-Gang — NEMA 3R Raintight when used with appropriate Ocal® boxes		
DS1282-	2-Plunger-Style Switch Cover	Aluminum

PVC-coated covers in other styles and materials are available upon request. Contact Technical Services for more information.

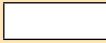
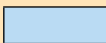
CAT. NO.	COLOR
DS23-	_____
	_____ = space for color identifier
	G = Gray 
	W = White 
	B = Blue 
	Custom colors also available.

PVC-Coated Hazardous Location Fittings

Specially designed for hazardous locations!

Ocal-Blue® Double-Coat STAR TECK EXTREME® STEX Series Fittings for Hazardous Locations

- Offers all the features of the STE Series
- Classified for Class I, Division 1, Groups A, B, C, D and Class II, Division 1, Groups E, F, G environments with approved metal-clad cable installed in accordance with NEC®/CEC requirements††
- Requires T&B® sealing compound for use in hazardous locations



PVC-Coated STEX Series Fittings for Hazardous Locations

CAT. NO.	HUB SIZE IN. METRIC SIZE DESIGNATOR**	STRIP LENGTH IN. MM	GLAND TORQUE LB.-IN. NM	RANGE OVER JACKET		RANGE OVER ARMOR		A1: THROAT DIA. MIN. W/END STOP IN. MM	A2: THROAT DIA. MIN. W/O END STOP IN. MM	B OVERALL HEIGHT IN. MM	C MAX. WIDTH IN. MM
				MIN. IN. MM	MAX. IN. MM	MIN. IN. MM	MAX. IN. MM				
STX050-462-_*	½	1.25	300	.53	.65	.42	.57	N/A***	.40	2.50	1.63
	16	31.75	33.90	13.46	16.51	10.67	14.48	N/A***	10.16	63.50	41.40
STX050-464-_*	½	1.25	300	.60	.76	.49	.68	N/A***	.49	2.53	1.63
	16	31.75	33.90	15.24	19.30	12.45	17.27	N/A***	12.45	64.26	41.40
STEX075-_*	¾	1.25	600	.60	.99	.52	.90	.50	.68	3.40	1.82
	21	31.75	67.79	15.24	25.15	13.21	22.86	12.70	17.27	86.36	46.23
STEX100-_*	1	1.25	700	.86	1.21	.78	1.13	.65	.83	3.58	2.30
	27	31.75	79.09	21.84	30.73	19.81	28.70	16.51	21.08	90.93	58.42
STEX125-_*	1¼	1.25	1000	.95	1.38	.87	1.30	.83	1.07	3.92	2.51
	3	31.75	112.98	24.13	35.05	22.10	33.02	21.08	27.18	99.57	63.75
STEX150-_*	1½	1.75	1200	1.15	1.63	.99	1.47	.96	1.27	5.02	3.26
	41	44.45	135.58	29.21	41.40	25.15	37.34	24.38	32.26	127.51	82.80
STEX200-_*	2	1.75	1600	1.44	1.97	1.28	1.81	1.25	1.56	5.12	3.62
	53	44.45	180.78	36.58	50.04	32.51	45.97	31.75	39.62	130.05	91.95
STEX250-†	2½	2.50	1600	1.83	2.38	1.67	2.22	1.64	2.00	5.17	4.58
	63	63.50	180.78	46.48	60.45	42.42	56.39	41.66	50.80	131.32	116.33
STEX300-†	3	2.50	1600	2.27	2.81	2.11	2.68	2.08	2.46	6.61	5.10
	78	63.50	180.78	57.66	71.37	53.59	68.07	52.83	62.48	167.89	129.54
STEX350-†	3½	2.50	1600	2.67	3.27	2.55	3.15	2.53	2.86	7.38	5.79
	91	63.50	180.78	67.82	83.06	64.77	80.01	64.26	72.64	187.45	147.07
STEX400-†	4	2.50	1600	3.22	3.87	3.09	3.64	3.06	3.46	7.65	6.19
	103	63.50	180.78	81.79	98.30	78.49	92.46	77.72	87.88	194.31	157.23
STX400-484-†	4	—	1600	3.81	4.03	3.68	3.87	—	—	—	—
	103	—	180.78	96.77	102.36	93.47	98.30	—	—	—	—
STX400-485-†	4	—	1600	3.97	4.19	3.84	4.03	—	—	—	—
	103	—	180.78	100.84	106.43	97.54	102.36	—	—	—	—

*These products are UL® Listed UL84H3 and watertight NEMA Type 6P.

***This fitting does not have a removable armor stop.

††Ratings prior to PVC coating.

**Metric size designator (ANSI C80.1-1994).

†CSA approved for hazardous locations.

T&B® Sealing Compounds — Used for Hazardous Locations

CAT. NO.	DESCRIPTION	VOLUME
SC4-KIT	Liquid-Type Sealing Compound for Use in Control Cable Applications	2.8 fl. oz.
SC65	Putty-Type Sealing Compound	60 grams

PVC-Coated Hazardous Location Fittings

Explosion-proof, dust-ignition-proof three-piece couplings.

Ocal-Blue® Double-Coat Conduit Unions

- Install in threaded thick-wall conduit systems in hazardous areas
- Use UNY male unions to connect conduit to a conduit fitting, junction box or device enclosure
- Use UNF female unions to connect conduit to conduit or to provide means for future modifications to the conduit system
- Nominal .002" (2 mil) blue urethane on interior and exterior
- Nominal .040" (40 mil) PVC coating bonded to exterior
- Pressure-sealing sleeves protect your connection
- Explosion-proof, dust-ignition-proof and suitable for use in the following environments:†
 - Class I, Division 1 & 2, Groups A, B, C, D
 - Class II, Division 1, Groups E, F, G
 - Class III, Division 1 & 2



UNF205-G



UNY Male 1/2"-4"
(shown uncoated)



UNY Male 5"-6"
(shown uncoated)



UNF Female 1/2"-4"
(shown uncoated)



UNF Female 5"-6"
(shown uncoated)



CAT. NO.	COLOR
UNF105-	
_ = space for color identifier	
G = Gray	
W = White	
B = Blue	
Custom colors also available.	

UNY Male Unions

CAT. NO.	PIPE SIZE IN. METRIC SIZE DESIGNATOR*	OVERALL LENGTH IN. MM	OVERALL DIAMETER IN. MM
UNY105-	1/2	2.39	1.50
	16	60.71	38.10
UNY205-	3/4	2.44	1.81
	21	61.98	45.97
UNY305-	1	2.75	2.00
	27	69.85	50.80
UNY405-	1 1/4	3.06	2.75
	35	77.72	69.85
UNY505-	1 1/2	3.63	3.06
	41	92.20	77.72
UNY605-	2	3.50	3.81
	53	88.90	96.77
UNY705-	2 1/2	4.81	4.31
	63	122.17	109.47
UNY805-	3	5.34	5.06
	78	135.64	128.52
UNY905-	3 1/2	5.50	5.69
	91	139.70	144.53
UNY1005-	4	5.63	6.19
	103	143.00	157.23
UNY905-	5	5.25	8.19
	129	133.35	208.03
UNY014-	6	5.38	9.31
	155	136.65	236.47

* Metric size designator (ANSI C80.1-1994).

UNF Female Unions

CAT. NO.	PIPE SIZE IN. METRIC SIZE DESIGNATOR*	OVERALL LENGTH IN. MM	OVERALL DIAMETER IN. MM
UNF105-	1/2	1.88	1.50
	16	47.75	38.10
UNF205-	3/4	2.13	1.81
	21	54.10	45.97
UNF305-	1	2.16	2.00
	27	54.86	50.80
UNF405-	1 1/4	2.25	2.75
	35	57.15	69.85
UNF505-	1 1/2	2.75	3.06
	41	69.85	77.72
UNF605-	2	2.50	3.81
	53	63.50	96.77
UNF705-	2 1/2	3.50	4.31
	63	88.90	109.47
UNF805-	3	4.00	5.06
	78	101.60	128.52
UNF905-	3 1/2	4.16	5.69
	91	105.66	144.53
UNF1005-	4	4.25	6.19
	103	107.95	157.23
UNF012-	5	3.81	8.19
	129	96.77	208.03
UNF014-	6	3.81	9.31
	155	96.77	236.47

† Ratings prior to PVC coating.

PVC-Coated Hazardous Location Fittings

Provides access to wiring, directional changes in conduit and more!

Ocal-Blue® Double-Coat GUA Series Conduit Boxes



GUA

Listings/Certifications†

- UL514A Wet Locations (when used with gasketed covers)
- UL886
- CSA C22.2 No. 30

GUA series conduit boxes are installed in hazardous areas to protect conductors, act as pull and splice boxes, provide access to conductors for maintenance and future system changes, act as mounting outlets for fixtures (with proper covers) or change conduit direction.

- Grade 60-45-10 ductile iron bodies and cast aluminum covers (iron covers also available)
- Nominal .002" (2 mil) blue urethane coating on both interior and exterior and nominal .040" (40 mil) PVC coating bonded to exterior
- All hubs have minimum five full threads, integral bushing and pressure-sealing sleeves
- All units furnished with internal grounding screw and ship complete with aluminum cover with O-ring gasket (covers also sold separately for replacement purposes)
- Explosion-proof, dust-ignition-proof, raintight and suitable for use in the following environments:†
 - Class I, Division 1 & 2, Groups C, D
 - Class II, Division 1, Groups E, F, G
 - Class III, Division 1 & 2
 - NEMA 3, 4, 7 CD, 9 EFG



GUAB



GUAC



GUAT



GUAX



CAT. NO.					ALUMINUM COVER ONLY	IRON COVER ONLY	PIPE SIZE IN. METRIC SIZE DESIGNATOR*	COVER OPENING IN. MM
GUA	GUAC	GUAT	GUAX	GUAB				
GUA14-	GUAC14-	GUAT14-	GUAX14-	GUAB14-	GUA04-	GUA04WOD-	½ 16	2.00 50.80
GUA24-	GUAC24-	GUAT24-	GUAX24-	GUAB24-	GUA04-	GUA04WOD-	¾ 21	2.00 50.80
GUA16-	GUAC16-	GUAT16-	GUAX16-	GUAB16-	GUA06-	GUA06WOD-	½ 16	3.00 76.20
GUA26-	GUAC26-	GUAT26-	GUAX26-	GUAB26-	GUA06-	GUA06WOD-	¾ 21	3.00 76.20
GUA36-	GUAC36-	GUAT36-	GUAX36-	GUAB36-	GUA06-	GUA06WOD-	1 27	3.00 76.20
—	—	GUAT37-	GUAX37-	—	GUA07-	GUA07WOD-	1 27	3.63 92.20
GUA47-	GUAC47-	GUAT47-	GUAX47-	GUAB47-	GUA07-	GUA07WOD-	1¼ 35	3.63 92.20
—	GUAC49-	GUAT49-	GUAX49-	—	GUA09-	GUA09WOD-	1¼ 35	5.00 127.00
GUA59-	GUAC59-	GUAT59-	GUAX59-	GUAB59-	GUA09-	GUA09WOD-	1½ 41	5.00 127.00
—	GUAC69-	GUAT69-	GUAX69-	GUAB69-	GUA09-	GUA09WOD-	2 53	5.00 127.00

†Ratings prior to PVC coating.

PVC-Coated Hazardous Location Fittings



GUAD



GUAL





GUAM



GUAN



GUAW

CAT. NO.	COLOR
GUA14 - _____	
_____	= space for color identifier
G	= Gray 
W	= White 
B	= Blue 
Custom colors also available.	



CAT. NO.					ALUMINUM COVER ONLY	IRON COVER ONLY	PIPE SIZE IN. METRIC SIZE DESIGNATOR*	COVER OPENING IN. MM
GUAD	GUAL	GUAM	GUAN	GUAW				
GUAD14_	GUAL14_	GUAM14_	GUAN14_	GUAW14_	GUA04_	GUA04WOD_	½ 16	2.00 50.80
GUAD24_	GUAL24_	GUAM24_	GUAN24_	GUAW24_	GUA04_	GUA04WOD_	¾ 21	2.00 50.80
GUAD16_	GUAL16_	GUAM16_	GUAN16_	GUAW16_	GUA06_	GUA06WOD_	½ 16	3.00 76.20
GUAD26_	GUAL26_	GUAM26_	GUAN26_	GUAW26_	GUA06_	GUA06WOD_	¾ 21	3.00 76.20
GUAD36_	GUAL36_	GUAM36_	GUAN36_	—	GUA06_	GUA06WOD_	1 27	3.00 76.20
—	GUAL47_	GUAM47_	GUAN47_	—	GUA07_	GUA07WOD_	1¼ 35	3.63 92.20
GUAD49_	GUAL49_	—	—	—	GUA09_	GUA09WOD_	1¼ 35	5.00 127.00
—	GUAL59_	—	GUAN59_	—	GUA09_	GUA09WOD_	1½ 41	5.00 127.00
—	GUAL69_	GUAM69_	GUAN69_	—	GUA09_	GUA09WOD_	2 53	5.00 127.00

PVC-Coated Hazardous Location Fittings

Junction boxes for branch conduits in hazardous locations.

Ocal-Blue® Double-Coat External Aluminum Hubs with Covers and Installed Green Ground Screw

- Accessible wiring chamber provides a convenient location to maintain or change a system, pull conductors and make splices
- Unique mounting pads and rugged protective housing ideal for installation of OEM devices or instruments
- Die-cast copper-free aluminum alloy A360 construction with precision cast and machined surfaces
- Precision NPT threaded hubs for trouble-free field installation
- Nominal .002" (2 mil) blue urethane coating on both interior and exterior and nominal .040" (40 mil) PVC coating bonded to exterior
- Explosion-proof, dust-ignition-proof, raintight and suitable for use in the following environments:^{††}
 - Class I, Division 1 & 2, Groups C, D
 - Class II, Division 1, Groups E, F, G
 - Class III, Division 1 & 2
 - NEMA 3, 4, 7 CD, 9 EFG (NEMA 4 rated when ordered with O-ring installed)



GALB



GAT



GAC



GAE



GAL



CAT. NO.						PIPE SIZE	COVER OPENING
THROUGH-FEED W/SURF. COVER GAC	DEAD END W/SURF. COVER GAE	L-STYLE W/SURF. COVER GAL	LB-STYLE W/SURF. COVER GALB	T-STYLE W/SURF. COVER GAT	SURFACE COVER ONLY GAS	IN. METRIC SIZE DESIGNATOR*	IN. MM
GAC-1- _†	GAE-1- _†	GAL-1- _†	GALB-1- _†	GAT-1- _†	GAS-123- _•	½	3.69
						16	93.73
GAC-2- _†	GAE-2- _†	GAL-2- _†	GALB-2- _†	GAT-2- _†	GAS-123- _•	¾	3.69
						21	93.73
GAC-3- _{†•}	GAE-3- _{†•}	GAL-3- _{†•}	GALB-3- _†	GAT-3- _†	GAS-123- _•	1	3.69
						27	93.73
GAC-4- _{†•}	—	GAL-4- _{†•}	GALB-4- _†	GAT-4- _†	GAS-4- _•	1¼	3.91
						35	99.31
GAC-5- _{†•}	—	GAL-5- _{†•}	GALB-5- _{†•}	GAT-5- _†	GAS-56- _•	1½	5.19
						41	131.83
GAC-6- _{†•}	—	GAL-6- _{†•}	GALB-6- _{†•}	GAT-6- _†	GAS-56- _•	2	5.19
						53	131.83

* Metric size designator (ANSI C80.1-1994).

• Made-to-order item. Consult factory for lead time and minimum quantities.

† Suffix -OR: O-ring available for NEMA 4 rating. Consult factory for lead time and price.

†† Ratings prior to PVC coating.

PVC-Coated Hazardous Location Fittings



GAX



GAFX



GAJU
(shown uncoated)



GAS



GAD



GAJ
(shown uncoated)

CAT. NO.	COLOR
GAC-1- _____	
_____	= space for color identifier
G = Gray	
W = White	
B = Blue	
Custom colors also available.	



CAT. NO.						PIPE SIZE	COVER OPENING
X-STYLE W/SURF. COVER GAX	X-STYLE W/FLANGE & SURF. COVER GAFX	U-STYLE SURFACE W/CANOPY COVER GAJU	SURFACE COVER ONLY GAS	DOMES COVER ONLY (CLASS I, GR. D) GAD	CANOPY COVER ONLY GAJ	IN. METRIC SIZE DESIGNATOR*	IN. MM
GAX-1- [†]	GAFX-1- [†]	GAJU-1-•	GALB-1- [†]	GAD-123-•	GAJ-123-•	½ 16	3.69 93.73
GAX-2- [†]	GAFX-2- [†]	GAJU-2-•	GALB-2- [†]	GAD-123-•	GAJ-123-•	¾ 21	3.69 93.73
GAX-3- ^{†•}	GAFX-3- [†]	GAJU-3-•	GALB-3- [†]	GAD-123-•	GAJ-123-•	1 27	3.69 93.73
GAX-4- ^{†•}	—	—	GALB-4- [†]	—	GAJ-4-•	1¼ 35	3.91 99.31
GAX-5- ^{†•}	—	GAJU-5-•	GALB-5- ^{†•}	—	GAJ-56-•	1½ 41	5.19 131.83
GAX-6- ^{†•}	—	GAJU-6-•	GALB-6- ^{†•}	—	GAJ-56-•	2 53	5.19 131.83

* Metric size designator (ANSI C80.1-1994).

• Made-to-order item. Consult factory for lead time and minimum quantities.

† Suffix -OR: O-ring available for NEMA 4 rating. Consult factory for lead time and price.

PVC-Coated Hazardous Location Fittings

Restrict the passage of gases, vapors and flames at atmospheric pressure and normal ambient temperatures.

Ocal-Blue® Double-Coat Sealing Fittings

- Prevents pre-compression or “pressure piling” in conduit systems
- Gray iron alloy body construction coated with nominal .002" (2 mil) blue urethane on both interior and exterior
- Nominal .040" (40 mil) PVC coating bonded to exterior — available in gray, white, blue or custom colors
- Explosion-proof, dust-ignition-proof and suitable for use in the following environments:[†]
 - Class I, Division 1 & 2, Groups C, D
 - Class II, Division 1, Groups E, F, G
 - Class III, Division 1 & 2

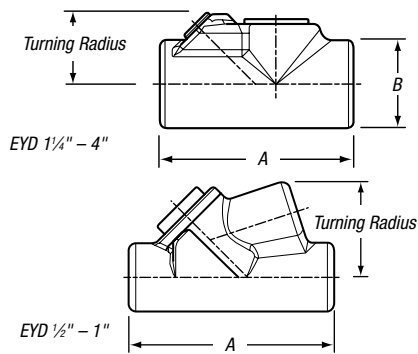

EYD Series Drain Sealing Fittings

FEMALE CAT. NO.	MALE & FEMALE CAT. NO.	PIPE SIZE IN. METRIC SIZE DESIGNATOR*	DIMENSIONS IN. MM		TURNING RADIUS IN. MM
			A	B	
EYD1_	EYD16_	1/2	3.81	1.50	1.75
		16	96.77	38.10	44.45
EYD2_	EYD26_	3/4	4.08	1.75	1.98
		21	103.63	44.45	50.29
EYD3_	EYD36_	1	4.85	2.19	2.19
		27	123.19	55.63	55.63
EYD4_	EYD46_	1 1/4	5.00	2.25	1.80
		35	127.00	57.15	45.72
EYD5_	EYD56_	1 1/2	5.44	2.44	2.00
		41	138.18	61.98	50.80
EYD6_	EYD66_	2	6.25	3.00	2.32
		53	158.75	76.20	58.93
EYD7_	EYD76_	2 1/2	7.50	3.50	2.69
		63	190.50	88.90	68.33
EYD8_	EYD86_	3	8.50	4.25	3.15
		78	215.90	107.95	80.01
EYD9_	EYD96_	3 1/2	9.19	4.75	3.38
		91	233.43	120.65	85.85
EYD10_	EYD106_	4	9.75	5.25	3.64
		103	247.65	133.35	92.46

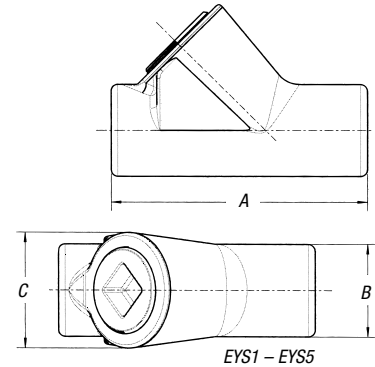

EYS Series Sealing Fittings

FEMALE CAT. NO.	MALE & FEMALE CAT. NO.	PIPE SIZE IN. METRIC SIZE DESIGNATOR*	DIMENSIONS IN. MM			TURNING RADIUS IN. MM
			A	B	C	
Vertical Only						
EYS1_	EYS16_	1/2	3.31	1.25	1.50	1.66
		16	84.07	31.75	38.10	42.16
EYS2_	EYS26_	3/4	3.65	1.50	1.75	1.96
		21	92.71	38.10	44.45	49.78
EYS3_	EYS36_	1	4.25	1.75	2.19	2.40
		27	107.95	44.45	55.63	60.96
Vertical or Horizontal						
EYS11_	EYS116_	1/2	3.63	1.25	—	1.09
		16	92.20	31.75	—	27.69
EYS21_	EYS216_	3/4	3.66	1.50	—	1.25
		21	92.96	38.10	—	31.75
EYS31_	EYS316_	1	4.25	1.75	—	1.59
		27	107.95	44.45	—	40.39
EYS4_	EYS46_	1 1/4	5.00	2.25	—	1.81
		35	127.00	57.15	—	45.97
EYS5_	EYS56_	1 1/2	5.44	2.44	—	2.00
		41	138.18	61.98	—	50.80
EYS6_	EYS66_	2	6.25	3.00	—	2.31
		53	158.75	76.20	—	58.67
EYS7_	EYS76_	2 1/2	7.50	3.50	—	2.56
		63	190.50	88.90	—	65.02
EYS8_	EYS86_	3	8.50	4.25	—	3.09
		78	215.90	107.95	—	78.49
EYS9_	EYS96_	3 1/2	9.19	4.75	—	3.38
		91	233.43	120.65	—	85.85
EYS10_	EYS106_	4	9.75	5.25	—	3.53
		103	247.65	133.35	—	89.66

* Metric size designator (ANSI C80.1-1994).

** EYSX and EYDX are expanded-fill styles. When ordering, add X to part number.

For example: EYSX31-G, EYDX31-B.

† Ratings prior to PVC coating.

PVC-Coated Hazardous Location Fittings



EZS



EZD



EZD
with Inspection Cover off

EZS Series Sealing Fittings

FEMALE CAT. NO.	MALE & FEMALE CAT. NO.	IN. METRIC SIZE DESIGNATOR*
EZS1-	EZS16-	½ 16
EZS2-	EZS26-	¾ 21
EZS3-	EZS36-	1 27
EZS4-	EZS46-	1¼ 35
EZS5-	EZS56-	1½ 41
EZS6-	EZS66-	2 53
EZS7-	EZS76-	2½ 63
EZS8-	EZS86-	3 78

* Metric size designator (ANSI C80.1-1994).

EZD Series Sealing Fittings

CAT. NO.	IN. METRIC SIZE DESIGNATOR*
EZD111-	½ 16
EZD211-	¾ 21
EZD311-	1 27
EZD411-	1¼ 35
EZD511-	1½ 41
EZD611-	2 53

* Metric size designator (ANSI C80.1-1994).

CAT. NO.	COLOR
EYS1-	_____
	_ = space for color identifier
G = Gray	
W = White	
B = Blue	
Custom colors also available.	

Ensures proper functioning of EYS sealing fittings.

Chico® Sealing Compound and Fiber

- Sealing compound mixes with water, pours easily and hardens in 60–70 minutes
- Fiber filler mineral wool holds sealing compound in place while it hardens

Ocal-Blue® Double-Coat EYS Sealing Fittings require fiber filler and sealing compound to function properly. Use Chico® X Fiber Filler to form a dam around the sealing fitting's integral bushing, as well as at the end of the conduit and around conductors entering the hub. Chico® A Sealing Compound expands slightly while hardening and bonds to the inner walls of the sealing fitting.



FIBER-X6



SEAL-A3

CAT. NO.	DESCRIPTION
SEAL-A3	Chico® A Sealing Compound, 1 lb. net wt./23 cu.in. vol.
FIBER-X6	Chico® X Fiber Filler, 8 oz.
SEALKIT-A4	Chico® A Sealing Compound, 1 lb. net wt./23 cu.in. vol., with 1 oz. Chico® X Fiber Filler

Chico® is a registered trademark of Cooper Crouse-Hinds.

PVC-Coated Strut and Accessories

Rugged steel channels protected by corrosion-resistant PVC!

Ocal® PVC-Coated Steel Strut

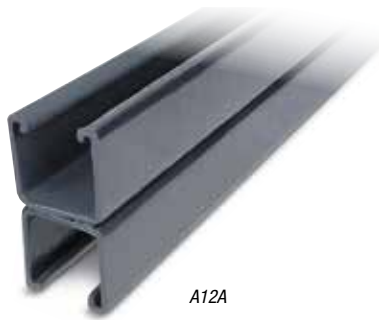

A12A



A12



A12P

- Channels cold formed from hot-rolled pickled and oiled strip steel
- Nominal .015" (15 mil) PVC coating
- PVC coating available in your choice of blue, white or gray standard colors
- Custom colors also available on request
- Sold in 10-ft. (3.048m) lengths with standard length tolerance of $\pm 1/8"$ (3.18mm)
- Choose between standard $1\frac{5}{8}"$ (41.28mm) and shallow $1\frac{3}{16}"$ (20.64mm) depths
- Available in both solid and punched styles
- Not recommended for vertical applications

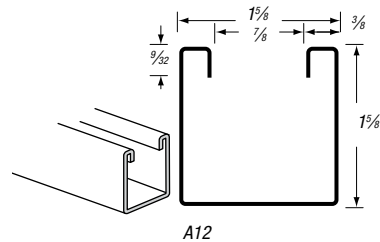

A12

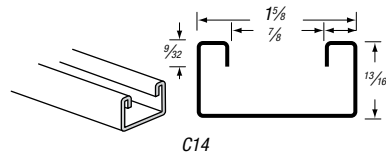

C14

CAT. NO.	COLOR
A12 -	_____
	_____ = space for color identifier
	G = Gray
	W = White
	B = Blue
Catalog No. Example:	Custom colors also available.
C14P-W is shallow punched strut channel coated in white PVC.	

CAT. NO.	STYLE	STEEL GAUGE MM	IN. MM	
			W	H
A12-__	Standard	12	1.63 x	1.63
		2.65	41.28 x	41.28
A12A-__	Back to Back	12	1.63 x	3.25
		2.65	41.28 x	82.55
A12P-__	Standard Punched	12	1.63 x	1.63
		2.65	41.28 x	41.28
C14-__	Shallow	14	1.63 x	.81
		1.89	41.28 x	20.64
C14P-__	Shallow Punched	14	1.63 x	.81
		1.89	41.28 x	20.64

PVC-Coated Strut and Accessories

Type 304 or Type 316 stainless — cold-roll formed for strength.

Stainless Steel Strut



- 12- or 14-gauge Type 304 or Type 316 stainless steel
- Available in 10-ft. (3.048m) and 20-ft. (6.096m) lengths with standard length tolerance of $\pm \frac{1}{8}$ " (3.18mm)
- Choose standard or shallow and solid or half-slot style

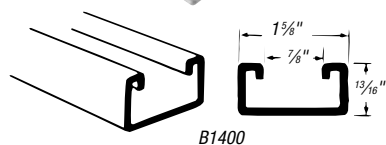
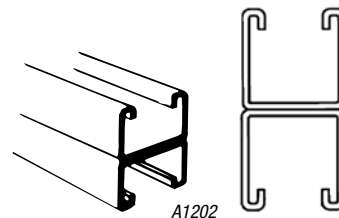

B1400

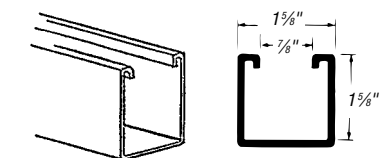

A1200

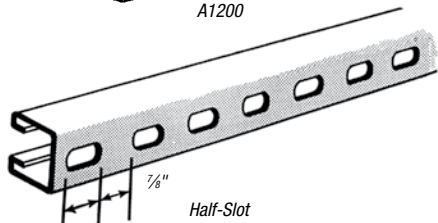

Half-Slot

TYPE 304 STAINLESS CAT. NO.	TYPE 316 STAINLESS CAT. NO.	STYLE	STEEL GAUGE MM	LENGTH FT. M	IN. MM	
					WIDTH	HEIGHT
A1200 10SS	A120010T316SS	Standard	12	10	1.63 x	1.63
			2.65	3.05	41.28 x	41.28
A1200 20SS	A120020T316SS	Standard	12	20	1.63 x	1.63
			2.65	6.10	41.28 x	41.28
A1200HS 10SS	A1200HS10T316SS	Standard Half-Slot	12	10	1.63 x	1.63
			2.65	3.05	41.28 x	41.28
A1200HS 20SS	A1200HS20T316SS	Standard Half-Slot	12	20	1.63 x	1.63
			2.65	6.10	41.28 x	41.28
B1400 10SS	B140010T316SS	Shallow	14	10	1.63 x	.81
			1.89	3.05	41.28 x	22.23
B1400 20SS	B140020T316SS	Shallow	14	20	1.63 x	.81
			1.89	6.10	41.28 x	22.23
A1202HS10SS	A1202HS10T316SS	Back-to-Back Half-Slot	12	10	1.63 x	3.25
			2.65	3.05	41.28 x	82.55
A1202HS20SS	A1202HS20T316SS	Back-to-Back Half-Slot	12	20	1.63 x	3.25
			2.65	6.10	41.28 x	82.55

Stainless Steel Hardware Accessories

TYPE 304 STAINLESS CAT. NO.	TYPE 316 STAINLESS CAT. NO.	SIZE
Flat Plate Fittings		
AB220SS	AB220SS316	5 5/8" x 3 1/2"
AB207SS	AB207SS6C	5 5/8"
X207SS	X207SS6C	7 1/4"
AB206SS	AB206SS6C	3 5/8"
90° Corner Fittings or Brackets		
AB201SS	AB201SS316	—
AB202SS	AB202SS316	1 5/8" x 2"
AB203SS	AB203SS316	—
AB204SS	AB204SS316	2 1/4" x 3 5/8"
AB213SS	AB213SS316	—
AB214SS	AB214SS316	—
AB219SS	AB219SS316	—
AW219SS	AW219SS316	9 5/8" x 3 7/8"
AB205SS	AB205SS316	—

TYPE 304 STAINLESS CAT. NO.	TYPE 316 STAINLESS CAT. NO.	SIZE
45° Fittings		
AB225SS	AB225SS316	3 1/2" x 2 1/2"
SPAB227SS	AB227SS316	3" x 2 5/8"
Pedestal Base		
AP232SS	AP232SS6	4 1/4" x 3 1/2"
AP232SQSS	AP232SQSS6	4 1/4" x 3 1/2"
AP235SS	AP235SS6	6" x 4"
AP235SQSS	AP235SQSS6	6" x 4"

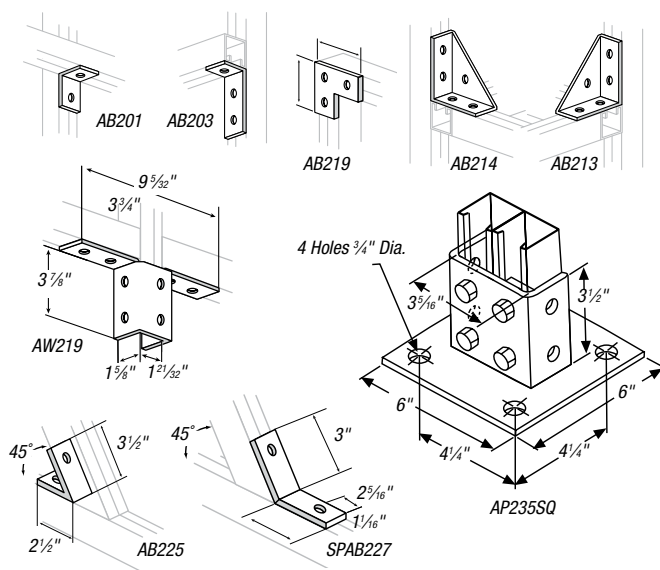

PVC-Coated Strut and Accessories

Stainless Steel Hardware Accessories (continued)

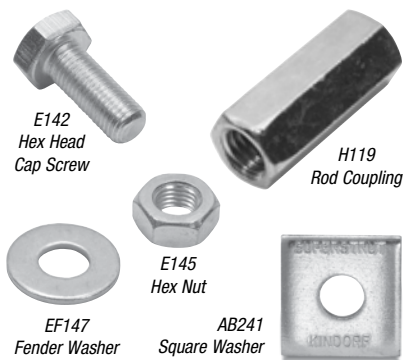

TYPE 304 STAINLESS CAT. NO.	TYPE 316 STAINLESS CAT. NO.	SIZE
Spring Nut — Regular		
—	A100 1/4 SS	1/4"
—	A100 5/16SS	5/16"
—	A100 3/8 SS	3/8"
Spring Nut — Short		
—	B100 1/4 SS	1/4"
—	B100 3/8 SS	3/8"
—	B100 1/2SS	1/2"
Springless Nut		
—	AB100 1/4 SS	1/4"
—	AB100 5/16SS	5/16"
—	AB100 3/8 SS	3/8"
Hex Head Cap Screw		
E142 (T) X (L) SS	E142 (T) X (L) SS316	—
Hex Nut		
E145 1/4 SS	—	1/4"
E145 5/16SS	—	5/16"
E145 3/8 SS	—	3/8"
E145 1/2 SS	—	1/2"

TYPE 304 STAINLESS CAT. NO.	TYPE 316 STAINLESS CAT. NO.	SIZE
Fender Washer		
EF147 1/4 SS	—	1/4"
EF147 3/8 SS	—	3/8"
EF147 1/2SS	—	1/2"
Square Washer		
AB241 1/4SS	AB241-1/4SS316	1/4"
AB241 5/16SS	—	5/16"
AB241 3/8 SS	AB241-3/8 SS316	3/8"
AB241 1/2SS	AB241-1/2SS316	1/2"
Rod Coupling		
H119 1/4SS	—	1/4"
H119 3/8SS	—	3/8"
H119 1/2SS	H119-1/2SS6	1/2"
U-Bolt Beam Clamps		
U501SS	—	3 3/8"H
U502SS	—	4 13/16"H

Continuously threaded rod for use with conduit hangers and strut to suspend overhead conduit runs.

All-Thread Rod

- All-thread steel rod coated with nominal .015" (15 mil) PVC in blue, white or gray with custom colors available on request
- Available in 1/4", 3/8" or 1/2" standard diameters and in 3-, 6- or 10-ft. standard lengths
- Also available uncoated in Type 304 or Type 316 stainless steel
- Stainless steel all-thread rod comes in 3/8" or 1/2" diameters in 6-ft. standard lengths with other diameters and lengths available on request

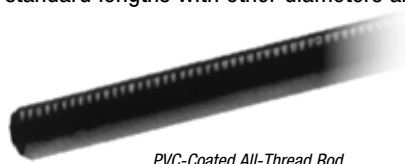

PVC-Coated All-Thread Rod

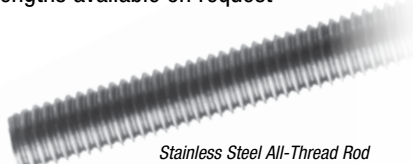

Stainless Steel All-Thread Rod

Ocal® PVC-Coated Steel All-Thread Rod

CAT. NO.	TRADE SIZE	LENGTH
	IN. MM	FT. M
THR1/4X10- _	1/4	10.00
	6.35	3.05
THR3/8X3- _	3/8	3.00
	9.53	0.91
THR3/8X6- _	3/8	6.00
	9.53	1.83
THR3/8X10- _	3/8	10.00
	9.53	3.05
THR1/2X3- _	1/2	3.00
	12.70	0.91
THR1/2X6- _	1/2	6.00
	12.70	1.83
THR1/2X10- _	1/2	10.00
	12.70	3.05

CAT. NO.	DIAMETER X LENGTH	COLOR
THR3/8X3-	_____	
_ = space for color identifier		
G = Gray		
W = White		
B = Blue		
Custom colors also available.		

Stainless Steel All-Thread Rod

TYPE 304 STAINLESS CAT. NO.	TYPE 316 STAINLESS CAT. NO.	TRADE SIZE IN. MM	LENGTH FT. M
H104-3/8X6SS	H104 3/8X6SS316	3/8	6.00
		9.53	1.83
H104 3/8X12SS	H104-3/8X12SS6	3/8	12.00
		9.53	3.66
H104-1/2X6SSC	H104-1/2X6SS6	1/2	6.00
		12.70	1.83
H104 1/2X12SS	H104 1/2X12SS316	1/2	12.00
		12.70	3.66

PVC-Coated Strut and Accessories

Corrosion-protected clamps for hanging threaded rod.

Ocal® PVC-Coated Hanger Rod Beam Clamps

- Malleable iron construction
- Nominal .015" (15 mil) PVC coating in blue, white, gray or custom colors
- 500, 502 and 503 also available uncoated in Type 316 stainless steel; add -SS316 to catalog number to order (for example: 502-SS316)

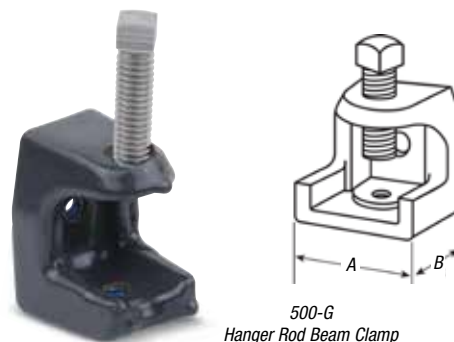

500-G
Hanger Rod Beam Clamp

CAT. NO.	COLOR
500 - _____	
_ = space for color identifier	
G = Gray	
W = White	
B = Blue	
Custom colors also available.	

CAT. NO.	BASE "A" IN. MM	BASE "B" IN. MM	JAW OPENING IN. MM	TAPPED HOLE IN. MM	LOAD RATING† LBS. KG
500-__	1 25.40	1¼ 31.75	1⁄16 23.81	¼ - 20 6.35 - 20	450 204.12
501-__	1½ 38.10	1¾ 41.28	3⁄16 22.23	5⁄16 - 18 7.94 - 18	800 362.87
502-__	2 50.80	2 50.80	1 25.40	¾ - 16 9.53 - 16	1300 589.67
503-__	2¾ 66.68	3 63.50	1 25.40	½ - 13 12.70 - 13	1300 589.67
508-__	2½ 63.50	2¾ 60.33	2¾ 53.98	½ - 13 12.70 - 13	1700 771.11

* Metric size designator (ANSI C80.1-1994).

† Load ratings based on bottom hole of beam clamp with safety factor of three.

CSA File No. LR-52208

Includes stainless steel bolt and nut for fast, easy installation.

Ocal® PVC-Coated Mini Conduit Hangers

- Nominal .015" (15 mil) PVC coating in blue, white, gray or custom colors
- Rated for loads of up to 500 lbs. (226.80kg) with a safety factor of three



MINE3/4-G
Mini Conduit Hanger

CAT. NO.	COLOR
MINE 1 - _____	
_ = space for color identifier	
G = Gray	
W = White	
B = Blue	
Custom colors also available.	

CAT. NO.	PIPE SIZE IN. METRIC SIZE DESIGNATOR*
MINE1/2-__	½ 16
MINE3/4-__	¾ 21
MINE1-__	1 27
MINE1-1/4-__	1¼ 35
MINE1-1/2-__	1½ 41
MINE2-__	2 53
MINE2-1/2-__	2½ 63
MINE3-__	3 78
MINE3-1/2-__	3½ 91
MINE4-__	4 103

* Metric size designator (ANSI C80.1-1994).

PVC-Coated Strut and Accessories

Designed for easy attachment of conduit to strut!

Pipe Straps for Strut

Just twist-insert these pipe straps anywhere you need them along the slot side of a channel. For additional flexibility, you can position the straps as closely as your pipe couplings permit.

- Combination slot and hex head bolt for flexibility of attachment
- Captivated square nut on shoulder enables easy one-handed tightening
- Use with either 1 5/8" or 1 1/2" strut for greater versatility
- Shipped pre-assembled for easier counting, sorting and handling
- Available with nominal .015" (15 mil) PVC coating in your choice of blue, white or gray standard colors (custom colors also available on request)
- Or choose uncoated Cobra® Clamps in Type 316 stainless steel



Stainless Steel
Cobra® Clamp



PVC-Coated
Pipe Strap

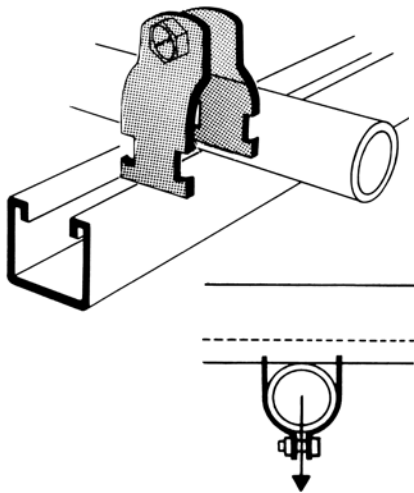

Stainless Steel Cobra® Clamp — Type 316

TYPE 316 STAINLESS CAT. NO.	PIPE SIZE IN. METRIC SIZE DESIGNATOR*
CPC075SS6	1/2 16
CPC100SS6	3/4 21
CPC100SS6	1 27
CPC150SS6	1 1/4 35
CPC150SS6	1 1/2 41
CPC200SS6	2 53
CPC250SS6	2 1/2 63
CPC300SS6	3 78
CPC350SST	3 1/2 91
CPC400SS6	4 103

* Metric size designator (ANSI C80.1-1994).

Note: Stainless steel strut straps are recommended only for use with stainless steel strut. Stainless steel straps may damage the PVC coating on PVC-coated strut.

Ocal® PVC-Coated Strut Pipe Straps

CAT. NO.	PIPE SIZE IN. METRIC SIZE DESIGNATOR*
SS1/2-	1/2 16
SS3/4-	3/4 21
SS1-	1 27
SS1-1/4-	1 1/4 35
SS1-1/2-	1 1/2 41
SS2-	2 53
SS2-1/2-	2 1/2 63
SS3-	3 78
SS3-1/2-	3 1/2 91
SS4-	4 103
SS5-	5 129

* Metric size designator (ANSI C80.1-1994).

CAT. NO.	SIZE	COLOR
SS 1-		
		—
		= space for color identifier
	G	Gray
	W	White
	B	Blue
Custom colors also available.		

PVC-Coated Strut and Accessories

Fewer parts, less installation time and huge labor savings!

Trapnut® Strut Fastener

The unique scissor action of the Trapnut® Strut Fastener closes at any desired position on the threaded rod. Once closed, precision threads trap the rod for a sturdy hold that can be adjusted up or down for fine-tune positioning. While the versatile Trapnut® Fastener has a locking pin that holds it in the desired position, it can also be removed and reused.



Standard method using nuts and washers



New method using Trapnut® Strut Fastener

Unlike a hex nut, there's no need to thread the Trapnut® Fastener from either end of the rod, saving valuable time on the job. While the Trapnut® Fastener is a time-saver for new work, it's invaluable for retrofit applications. Rather than disassembling an existing trapeze to run additional conduit above it, simply clamp the Trapnut® Fastener between the trapeze and beam clamp for a speedy retrofit solution. It's ideal for applications where the rod ends aren't accessible.

The Trapnut® Fastener offers sturdy, load-bearing steel construction, so you can be confident of a solid installation. In addition, the Trapnut® Fastener functions as a hex nut, square washer and flat washer all in one, so there are fewer parts to keep track of on the job.

- Takes 30% less time than the traditional method on new work*
- Takes 43% less time than the traditional method on retrofit applications*

* Based on time study conducted by Thomas & Betts comparing the time to install 15 feet of 2" conduit with typical trapeze assemblies using washers and nuts versus Trapnut® fasteners.



Type 316 Stainless Steel Trapnut® Fastener

CAT. NO.	MATERIAL	SIZE IN. MM	DESIGN LOAD LBS. KG
H122-1/4-SS6	Type 316 Stainless Steel	¼" 6.35	150.00 68.04
H122-3/8-SS6	Type 316 Stainless Steel	⅜" 9.53	590.00 267.62
H122-1/2-SS6	Type 316 Stainless Steel	½" 12.70	1080.00 489.88

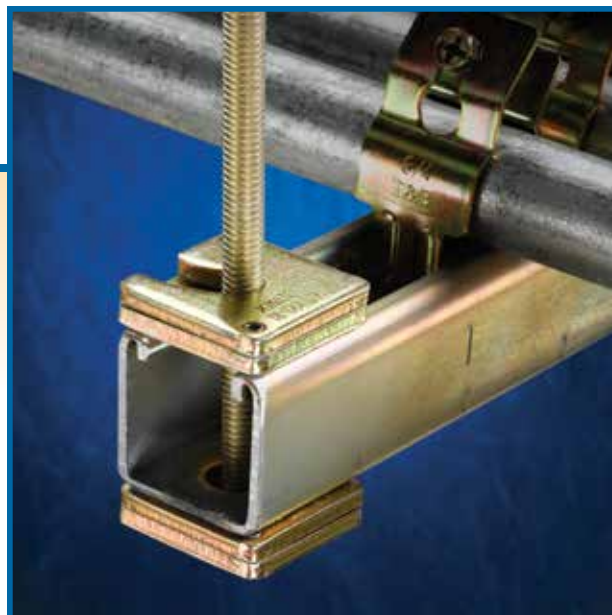

Trapnut® Fastener is Quick and Easy to Install

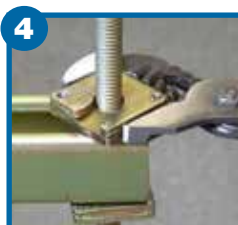
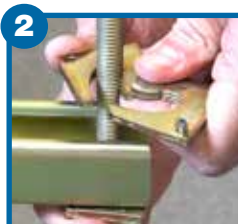
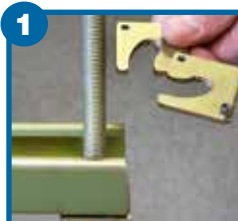

Hold in the open position.

- No need to thread the Trapnut® Fastener from either end of the rod — saves valuable time
- Perfect for retrofit applications where the rod ends are not accessible

Insert the bottom plate on the rod and close the top plate.

- Precision threads trap the threaded rod for a sturdy hold that can be adjusted up or down for fine-tune positioning
- Functions as a hex nut, square washer and flat washer combined

Press the pin with pliers.

- Locking pin holds Trapnut® Fastener in the desired position
- Can be removed and reused

Tighten to the desired position with pliers.

- Can be adjusted up or down for fine-tune positioning
- Sturdy, load-bearing stainless steel construction
- Sized to provide custom fit for either 1½" or 1½" strut systems

Ocal® Installation Products

The Right Tools for the Job!

Thomas & Betts Ocal® PVC-Coated Conduit is designed to prevent corrosion from striking weak points in conduit systems. But any PVC-coated conduit system is only as good as the installation job. The wrong tools can result in incorrectly installed pipes and fittings or damage to PVC coating, creating those weak points where corrosion starts.

After careful research and evaluation, Thomas & Betts now offers you the very best installation tools available for PVC-coated conduit. These tools are ready for use on PVC-coated conduit right out of the box. What that means to you, the installer, is lower costs — in equipment, in installation time and in time you'd normally have to spend adapting standard tools for use on PVC-coated conduit.



Hassle-Free Installation

Count on Thomas & Betts to provide a hassle-free way for installers to get the right tools for the job in their hands — just another benefit of using Ocal® products.

For more information on Ocal® Installation Guidelines, see **pages 65–71**.

Ocal® Installation Products

Bends 1/2" through 2" PVC-coated conduit.

GREENLEE® Model 555 Electric Bender for PVC-Coated Conduit

When you use this electric bending machine on 1/2" through 2" conduit, the shoes as well as the roller assembly should be of the type designed specifically for use with PVC-coated conduit.

If you use conventional shoes, the shoes and each of the rollers in the roller assembly must be machined 60 thousandths. Some manufacturers use slide bars instead of a roller assembly, and these, too, must be machined 60 thousandths.

Be sure to compensate for "spring back," since PVC coating often requires the setting to be off as much as 5°.



Conduit & Fittings — Ocal® Corrosion-Resistant Conduit Systems

CAT. NO.	DESCRIPTION
GBENDER	GREENLEE® Model 555 Bender
Shoes and Roller Kit for 40-mil PVC-Coated Conduit	
37279	1/2" – 2" Shoes and Roller Supports
Kit Consists of One Each:	
00946	1/2" through 1 1/4" Roller Support
00573	1/2" through 1 1/4" Shoe
37281	1 1/2" and 2" Shoe
37282	1 1/2" through 2" Roller Support
23818	Metal Storage Box

Make saddles, offsets and conventional bends.

Hand Bender for PVC-Coated Conduit

CAT. NO.	CONDUIT SIZE
35220	1/2"
35225	3/4"
2424A8	1"



Ocal® Installation Products

High-speed threading — up to 25 rpm!

RHINO® High-Performance Threading Machine



RHINO® Threading Machine with optional wheeled stand

- Standard threading machine with built-in pipe cutter, reamer, foot-operated safety switch, ½" to 2" and 2½" to 4" automatic die heads and precision alloy dies
- Heavy-duty, 115V AC/DC, 50/60 Hz motor develops up to 3hp
- Quiet operation — 85dB maximum noise level
- Easy to maintain and service
- Precision pipe cutter with dual guide for accuracy and control
- COLLINS® SUPER GRIP R/L chucking system features four heavy-duty jaws, specially designed for PVC-coated conduit, at front and rear to automatically grip and center pipe

CAT. NO.	DESCRIPTION
RHINO® High-Performance Threading Machine	
P00551C	RHINO® ½"-4" Threading Machine with Jaws for PVC-Coated Conduit
ROTH00548	Optional Wheeled Stand with Tool Tray for RHINO® Threading Machine
Replacement Threading Die Sets for RHINO® Threading Machine	
89101	½"-¾" Threading Die Set
89102	1"-2" Threading Die Set
59912	2½"-4" Threading Die Set
Replacement Jaws Sets for RHINO® Threading Machine	
P20305C	Jaw Set for PVC-Coated Conduit
ROTH02385	Jaw Set for Galvanized Rigid Conduit

Portable and compact for mobile use and hard-to-reach spaces!

SUPERTRONIC® 2000 Power Threader



- Quick and easy production of precision-threaded joints to approved standards
- Dust-tight casing with sealed lubrication ensures long service life and low maintenance
- Optimized gearing for high-performance output with minimal energy consumption
- 15–25 rpm threading speed with 60 rpm rapid reverse for time savings
- Complete set includes SUPERTRONIC® 2000, forged pipe clamp, thread-cutting spray, quick-change die heads with tempered-steel precision dies for ½", ¾", 1", 1¼", 1½" and 2" PVC-coated conduit and carrying case



Forged pipe clamp, shown above, is included with the P71259C SUPERTRONIC® 2000 Power Threader Set

CAT. NO.	DESCRIPTION
P71259C	SUPERTRONIC® 2000 Power Threader Set for ½", ¾", 1", 1¼", 1½" and 2" PVC-Coated Conduit

Ocal® Installation Products

Threads ½" to 2" conduit in seconds!

MINI-COLLINS® Electric Power Drive

- Lightweight, compact design goes anywhere — only 28" long and requires only 1¾" clearance in trenches, overhead and other tight spaces
- Easy to maintain — built-in fill plug eliminates disassembly of gearbox for oiling
- 115V, 15A reversible motor provides the power to make any turning job easier
- Tightens nuts, drives cable pullers, turns hoists and jacks, opens and closes valves and drives up to 6" geared threaders
- Compatible with RIDGID® 12R die heads
- Cat. No. 13158 Adapter enables SUPER CUT die heads (below) to be used with ROTHENBERGER® MINI-COLLINS® and RIDGID® Model 700 portable threading machines



MINI-COLLINS® Electric Power Drive



The two-piece 13158 adapter enables the use of SUPER CUT die heads with the MINI-COLLINS®. For dies up to 1¼" in size, use both pieces together, as shown at above right. For larger dies, separate the two pieces, as shown at above left, and use only the outer ring.

CAT. NO.	DESCRIPTION
MINI-COLLINS® Electric Power Drive & Accessories	
ROTH00074	MINI-COLLINS® Electric Power Drive
13158	MINI-COLLINS® Adapter for SUPER CUT Die Heads
ROTH00117	MINI-COLLINS® 1" Square Shaft Drive for Geared Threaders
ROTH00119	Steel Carrying Case for MINI-COLLINS®

Machined to thread PVC-coated conduit.

SUPER CUT Die Heads



- Optimized cutting geometry offers easy starting and excellent shaving discharge
- Purchase dies individually
- Or choose the complete set, including ratchet handle, quick-change die heads, tempered-steel precision dies for ½", ¾", 1", 1¼", 1½" and 2" PVC-coated conduit and plastic carrying case
- Fit SUPERTRONIC® 2000 threader
- Use with MINI-COLLINS® (above) or RIDGID® Model 700 with Catalog No. 13158 adapter (above)

CAT. NO.	DESCRIPTION
P70905C	Complete Die Set for ½" – 2"
P70912C	½" Die
P70913C	¾" Die
P70914C	1" Die
P70915C	1¼" Die
P70849C	1½" Die
P70850C	2" Die

Ocal® Installation Products

Equipped with chain vise.

Tri-Stand Vise

- Sturdy, stable frame collapses for easy mobility and storage
- Ceiling brace for overhead support enables you to secure frame even during difficult work
- Features recesses for bending tubes 3/8", 1/2" and 3/4" O.D.



ROTH00076

CAT. NO.	DESCRIPTION	PIPE CAPACITY IN. METRIC SIZE DESIGNATOR*
ROTH00076	Tri-Stand with 6" Chain Vise (use with Ocal® Half-Shell Clamps)	1/2 – 6 16 – 155

* Metric size designator (ANSI C80.1-1994).

Superior design and construction for faster, safer chain-vise clamping of PVC-coated conduit.

Ocal® Half-Shell Clamps

If you already have a chain vise, now you can avoid the expense of purchasing a yoke vise with special jaws — or the trouble of making clamps out of PVC or steel pipe — to cut and thread PVC-coated conduit. These Half-Shell Clamps come in the full range of 1/2" to 6" trade sizes. Buy the individual sizes you need, or choose our convenient set, which contains all the sizes from 1/2" to 2" in a handy carrying/storage case.

A unique internal design ensures secure clamping while protecting the integrity of the conduit's PVC coating. Cast from ductile iron for extreme strength and durability, Ocal® Half-Shell Clamps offer you years of consistent, reliable service.



- Two-piece construction, cast from ductile iron for exceptional strength, durability and performance
- Cross-hatched interior surface grips conduit securely while safeguarding PVC jacket from damage
- Available individually in 1/2" through 6" trade sizes
- Also available in a convenient set – 1/2" to 2" trade sizes
- Each clamp clearly marked with trade size for easy identification
- Openings at each end enable hanging for handy storage



CAT. NO.	CONDUIT SIZE	
	IN.	METRIC*
<i>Individual Half-Shell Clamps</i>		
HLF-SHL-CLP1/2	1/2	16
HLF-SHL-CLP3/4	3/4	21
HLF-SHL-CLP1	1	27
HLF-SHL-CLP1-1/4	1 1/4	35
HLF-SHL-CLP1-1/2	1 1/2	41
HLF-SHL-CLP2	2	53
HLF-SHL-CLP2-1/2	2 1/2	63
HLF-SHL-CLP3	3	78
HLF-SHL-CLP3-1/2	3 1/2	91
HLF-SHL-CLP4	4	103
HLF-SHL-CLP5	5	129
HLF-SHL-CLP6	6	155
<i>Half-Shell Clamp Set (in carrying/storage case)</i>		
HLF-SHL-CLP-SET1	1/2 – 2	16–53

* Metric size designator (ANSI C80.1-1994).

Ocal® Installation Products

Designed to hold PVC-coated conduit safely and securely in a yoke-style vise.

Ocal® Jaws for PVC-Coated Conduit

- Replaces the standard jaw inserts in a yoke vise
- Provides greater clamping force and prevents pipe from spinning during threading
- Machined aluminum construction
- Three-piece set



CAT. NO.	DESCRIPTION	WEIGHT	
		LBS.	KG
JAWS23	Used with RIDGID No. 23 Yoke Vise	2.80	1.27

Specially designed for cutting PVC-coated conduit.

Steel Pipe Cutters

- Easy pressure control transmits optimum force onto tube
- Hardened, high-alloy steel cutter wheel provides long service life and burr-free external cutting



CAT. NO.	DESCRIPTION	PIPE O.D.
P70045C	Steel Pipe Cutter — Up to 2"	1/8"–2"
P70060C	Steel Pipe Cutter — Up to 4"	1/8"–4"

Rapid and clean deburring!

Ratchet Pipe Reamer

- Smooth-running ratchet
- Tempered-steel cutting bit
- For steel tubes 1/4" to 2" O.D.

CAT. NO.	DESCRIPTION	PIPE O.D.
70289	Ratchet Pipe Reamer	1/4"–2"



Ocal® Installation Products

Removable aluminum jaws for PVC-coated conduit.

Ocal® J-Wrenches

Use with our pliers, or purchase just the jaws and adapt your own!



J460



J460



J42



J442

CAT. NO.	DESCRIPTION	PIPE CAPACITY
J442	12" J-Wrench with Jaws	½" to 1¼"
J460	16" J-Wrench with Jaws	1½" to 2½"
J42	12" Jaw Set only	½" to 1¼"
J60	16" Jaw Set only	1½" to 2½"

Jaws grip PVC-coated pipe securely without damaging the plastic coating!

Aluminum Pipe Wrenches

- Extremely light aluminum alloy offers high strength but weighs 40% less than standard cast
- Self-clamping, spring-supported hook for easy, one-handed, ratchet-like use
- Scale on hook for quick preset of tube diameter



CAT. NO.	LENGTH IN. MM	STEEL TUBE O.D. MAX. IN. METRIC SIZE DESIGNATOR*
P70159C	10 254	1½ 16
P70160C	14 356	2 53
P70161C	18 457	2½ 63
P70162C	24 610	3 78

* Metric size designator (ANSI C80.1-1994).

Specially coated strap won't absorb oil.

Strap Wrenches



31370

31355

CAT. NO.	HANDLE LENGTH IN. MM	STRAP LENGTH IN. MM	STRAP WIDTH IN. MM	PIPE CAPACITY IN. MM	PIPE CAPACITY (O.D.) IN. MM	WEIGHT LBS. KG
31355	11.75 298.45	17.00 431.80	1.75 44.45	2.00 50.80	3.50 88.90	1.75 .79
31370	18.00 457.20	29.25 742.95	1.75 44.45	5.00 127.00	5.50 139.70	2.75 1.25

Ocal® Installation Products

Protects, lubricates and enhances the conductivity of all electrical connections!

KOPR-SHIELD® Joint Compound

- Meets NEC® requirements for protection against corrosion: *“Where corrosion protection is necessary and the conduit is threaded in the field, all threads shall be coated with an approved electrically conductive, corrosion-resistant compound.”*
- Extremely adhesive compound flows smoothly into uneven contours and voids, ensuring easy application and complete, positive protection and lubrication
- Won't settle out, thin, thicken, harden or dry out under the most severe environmental conditions
- Excellent temperature characteristics — can be brushed on at -50° F to 250° F (-45° C to 121° C) and remains intact for short periods even at 1,800° F (982° C)
- Ensures low resistance and seals out air and moisture
- Unique, homogenized blend of pure, polished colloidal copper, rust and corrosion inhibitors

NEC and National Electrical Code are registered trademarks of the National Fire Protection Association, Inc.



KOPR-SHIELD® Joint Compound

CAT. NO.	CONTAINER	SIZE
201-31879	Brush Cap Can	1½ oz. (.04 liter)
201-31879-1	Brush Cap Can	4 oz. (.12 liter)
CP8-TB	Brush Cap Can	8 oz. (.24 liter)
CP16	Brush Cap Can	1 pint (.47 liter)
CP128	Can	1 gallon (3.79 liter)

Note: Not recommended for food & beverage processing applications.

Conduit & Fittings — Ocal® Corrosion-Resistant Conduit Systems



Fast-drying, air-cure patch for Ocal® conduit and fittings.

Ocal® Touch-Up Compounds

CAT. NO.	CONTAINER	SIZE	COLOR
Exterior PVC Patch			
SPRAY-G	Spray Can	12½ oz. (.37 liter)	Dark Gray
SPRAY-W	Spray Can	12½ oz. (.37 liter)	White
SPRAY-B	Spray Can	12½ oz. (.37 liter)	Light Blue
PATCHP-G	Brush Cap Can	1 pint (.47 liter)	Dark Gray
PATCHP-W	Brush Cap Can	1 pint (.47 liter)	White
PATCHP-B	Brush Cap Can	1 pint (.47 liter)	Light Blue
PATCHG-G	Bottle	1 gallon (3.79 liter)	Dark Gray
PATCHG-W	Bottle	1 gallon (3.79 liter)	White
PATCHG-B	Bottle	1 gallon (3.79 liter)	Light Blue
Interior Urethane Patch			
URETHANEPATCH	Brush Cap Can	1 pint (.47 liter)	Blue

Ocal® Installation Products

A better patching solution for hot weather applications!

Ocal® Heat-Cure Patch

Even in the best of installations, the PVC jacket on PVC-coated conduit or fittings can be cut, nicked or abraded. To maintain corrosion protection, Ocal® has added a new, thicker PVC patch to its offering of touch-up compounds.

Ideal for use in hot weather, Ocal® Heat-Cure Patch offers a thicker consistency at high ambient temperatures than standard air-cure patches, ensuring better coverage and a more effective patch.

Ocal® Heat-Cure Patch makes patching fast and easy.

- 1 Make sure the area to be patched is clean and dry.
- 2 Squeeze the amount of patch material needed onto the area to be repaired.
- 3 If necessary, spread and level the patch material with a putty knife.
- 4 Apply heat with a heat gun or torch, such as the T&B® Portable Heat-Shrink Torch.
- 5 Being careful not to overheat (500° F/260° C max.), apply heat for two minutes total, or at least one minute after surface of patch has turned glossy. (The patch material is a glossy liquid that turns flat with initial heat application and then turns glossy again as heating continues.)
- 6 Allow the patched area to air cool, or use a water quench.



NEW!

CAT NO.	COLOR	SIZE
PATCHT-G	Dark Gray	6 oz. (.18 liter)
PATCHT-W	White	6 oz. (.18 liter)
PATCHT-B	Light Blue	6 oz. (.18 liter)

Separate controls enable precise adjustment of flame and temperature!

T&B® Portable Heat-Shrink Torch

- 2,500° F (1,371° C) output capacity satisfies virtually any heating, brazing or soldering requirement
- Dual fuel- and air-flow controls enable separate adjustment of temperature and flame precision
- Brass and steel construction provides durability
- Operates on standard butane lighter fluid (not included)

Specifications

- Dimensions (without base) L x W x H:
3.90" x 1.40" x 5.40"
99.06mm x 35.56mm x 137.16mm
- Weight (when filled):
9.88 oz.
280.09g
- Fuel Tank Capacity:
2.03 fl. oz.
60.03ml
- Operating Time (per full fuel tank):
Up to 220 minutes



CAT. NO.	DESCRIPTION
WT-PTORCH	Portable Heat-Shrink Torch

Technical Information

Ocal® PVC Exterior Coating Chemical Resistance

SOLUTIONS	CONC.	TEMP.	RECOMMENDED EXPOSURE		
			SPLASHING	LIQUID	FUMES
Acetic Acid	10%	120	no	no	no
Acid Copper Plating Solution		160	yes	yes	yes
Alkaline Cleaners		160	yes	yes	yes
Aluminum Chloride	Sat'd	160	yes	yes	yes
Aluminum Sulfate	Sat'd	160	yes	yes	yes
Alums	Sat'd	160	yes	yes	yes
Ammonium Chloride	Sat'd	160	yes	yes	yes
Ammonium Hydroxide	28%	120	yes	yes	yes
Ammonium Hydroxide	10%	120	yes	yes	yes
Ammonium Sulfate	Sat'd	160	yes	yes	yes
Ammonium Thiocyanate	Sat'd	160	yes	yes	yes
Amyl Alcohol	Any	90	yes	yes	yes
Arsenic Acids	Any	150	yes	yes	yes
Barium Sulfide	Sat'd	120	yes	yes	yes
Black Liquor	Sat'd	90	yes	yes	yes
Benzoic Acid	Sat'd	160	yes	yes	yes
Brass Plating Solution	Any	160	yes	yes	yes
Bromine Water	Sat'd	120	yes	yes	yes
Butyl Alcohol	Any	90	yes	yes	yes
Cadmium Plating Solution	Any	150	yes	yes	yes
Calcium Bisulfite	Any	150	yes	yes	yes
Calcium Chloride	Sat'd	160	yes	yes	yes
Calcium Hypochlorite	Sat'd	120	yes	yes	yes
Carbonic Acid	Sat'd	160	yes	yes	yes
Casein	Sat'd	90	yes	yes	yes
Castor Oil	Any	90	yes	yes	yes
Caustic Soda	35%	120	yes	yes	yes
Caustic Soda	10%	150	yes	yes	yes
Caustic Potash	35%	120	yes	yes	yes
Caustic Potash	10%	150	yes	yes	yes
Chlorine Water	Sat'd	90	yes	yes	yes
Chromium Plating Solution	Any	150	yes	yes	yes
Citric Acid	Sat'd	160	yes	yes	yes
Copper Chloride (Cupric)	Sat'd	160	yes	yes	yes
Copper Cyanide Plating Sol (High Speed)	Any	160	yes	yes	yes
(with Alkali Cyanides)	Any	180	yes	yes	yes
Copper Sulfate	Sat'd	160	yes	yes	yes
Coconut Oil	Sat'd	90	yes	yes	yes
Cottonseed Oil	Sat'd	90	yes	yes	yes
Disodium Phosphate	Sat'd	160	yes	yes	yes
Ethyl Alcohol	Any	90	yes	yes	yes
Ethylene Glycol	Any	90	yes	no	yes
Ferric Chloride	45%	120	yes	yes	yes
Ferrous Sulfate	Sat'd	150	yes	yes	yes
Fluoboric Acid	Any	150	yes	yes	yes
Formaldehyde	37%	120	yes	yes	yes
Formic Acid	85%	100	no	no	no
Gallic Acid	Sat'd	150	no	no	yes
Glucose	Any	150	yes	yes	yes
Glue	Any	150	yes	yes	yes
Glycerine	Any	90	yes	yes	yes
Gold Plating Solution	Any	150	yes	yes	yes
Hydrochloric Acid	10%	120	yes	no	yes
Hydrochloric Acid	21.5%	120	yes	no	yes
Hydrochloric Acid	37.5%	120	yes	no	yes
Hydrochloric Acid	37.5%	90	yes	no	yes
Hydrofluoric Acid	4%	140	yes	no	yes
Hydrofluoric Acid	10%	120	yes	no	yes
Hydrofluoric Acid	48%	120	yes	no	yes
Hydrogen Peroxide	30%	120	yes	yes	yes
Hydrogen Sulfide	Sat'd	120	yes	yes	yes
Hydroquinone	Any	90	yes	yes	yes
Indium Plating Solution	Any	150	yes	yes	yes
Lactic Acid	50%	120	yes	yes	yes
Lactic Acid	Any	90	yes	yes	yes

SOLUTIONS	CONC.	TEMP.	RECOMMENDED EXPOSURE		
			SPLASHING	LIQUID	FUMES
Lead Plating Solution	Any	150	yes	yes	yes
Malic Acid	Any	90	yes	yes	yes
Methyl Alcohol	Any	90	yes	yes	yes
Mineral Oils	Any	90	yes	yes	yes
Nickel Acetate	Sat'd	160	yes	yes	yes
Nickel Plating Solution		160	yes	yes	yes
Nickel Salts	Sat'd	160	yes	yes	yes
Nitric Acid	35%	120	yes	no	yes
Nitric Acid	40%	90	yes	no	yes
Nitric Acid	60%	120	yes	no	yes
Nitric Acid/ Hydrofluoric Acid	15% 4%	140	yes	yes	yes
Nitric Acid/ Sodium Dichromate	16% 13%	130	yes	yes	yes
Water	71%				
Oleic Acid	Any	90	yes	yes	yes
Oxalic Acid	Sat'd	120	yes	yes	yes
	Any	90	yes	yes	yes
Phenol	Sat'd	120	no	no	no
Phosphoric Acid	75%	150	yes	yes	yes
Phosphoric Acid	85%	120	yes	yes	yes
Phosphoric Acid	85%	160	yes	yes	yes
Potassium Acid Sulfate	Sat'd	150	yes	yes	yes
Potassium Antimonate	Sat'd	150	yes	yes	yes
Potassium Bisulfite	Sat'd	90	yes	yes	yes
Potassium Chloride	Sat'd	160	yes	yes	yes
Potassium Cuprocyanide	Sat'd	150	yes	yes	yes
Potassium Cyanide	Sat'd	160	yes	yes	yes
Potassium Dichromate	Sat'd	160	yes	yes	yes
Potassium Hypochlorite	Sat'd	90	yes	no	yes
Potassium Sulfide	Sat'd	150	yes	yes	yes
Potassium Thiosulfate	Sat'd	150	yes	yes	yes
Propyl Alcohol	Sat'd	150	yes	yes	yes
Rhodium Plating Solution	Sat'd	150	yes	yes	yes
Silver Plating Solution	Sat'd	150	yes	yes	yes
Soaps	Any	90	yes	yes	yes
Sodium Acid Sulfate	Sat'd	160	yes	yes	yes
Sodium Antimonate	Sat'd	150	yes	yes	yes
Sodium Bicarbonate	Sat'd	160	yes	yes	yes
Sodium Bisulfite	Sat'd	90	yes	yes	yes
Sodium Chloride	Sat'd	160	yes	yes	yes
Sodium Cyanide	Sat'd	160	yes	yes	yes
Sodium Dichromate	Sat'd	160	yes	yes	yes
Sodium Hydroxide	10%	150	yes	no	yes
Sodium Hydroxide	35%	120	yes	no	yes
Sodium Hydroxide	73%	160	no	no	no
Sodium Hypochlorite	Sat'd	90	yes	no	yes
Sodium Hypochlorite	15%	120	yes	no	yes
Sodium Sulfide	Sat'd	150	yes	yes	yes
Sodium Thiosulfate	Sat'd	150	yes	yes	yes
Sulfuric Acid	15%	120	yes	yes	yes
Sulfuric Acid	15%	160	yes	yes	yes
Sulfuric Acid	50%	120	yes	yes	yes
Sulfuric Acid	70%	90	yes	no	yes
Sulfuric Acid	98%	100	no	no	yes
Sulfurous Acid	2%	120	yes	no	yes
Sulfurous Acid	6%	120	yes	no	yes
Tannic Acid	Sat'd	90	yes	yes	yes
Tartaric Acid	Sat'd	90	yes	yes	yes
Tin Chloride Aqueous	Sat'd	150	yes	yes	yes
Tin Plating Solution	Sat'd	150	yes	yes	yes
Triethanolamine	Sat'd	150	yes	yes	yes
Trisodium Phosphate	Sat'd	150	yes	yes	yes
Water	Sat'd	160	yes	yes	yes
White Liquor		90	yes	yes	yes
Zinc Plating Solution		160	yes	yes	yes
Zinc Sulfate	Sat'd	160	yes	yes	yes

Technical Information

Ocal® Urethane Interior Coating Chemical Resistance

SOLUTIONS	CONC.	TEMP.	RECOMMENDED EXPOSURE		
			SPLASHING	LIQUID	FUMES
Acetic Acid	10%	75	yes	no	yes
Acid Copper Plating Solution	Any	75	yes	no	yes
Alkaline Cleaners	Any	75	yes	no	yes
Aluminum Chloride	Sat'd	75	yes	no	yes
Aluminum Sulfate	Sat'd	75	yes	no	yes
Alums	Sat'd	75	yes	no	yes
Ammonium Chloride	Sat'd	75	yes	no	yes
Ammonium Hydroxide	28%	75	yes	no	yes
Ammonium Hydroxide	10%	75	yes	no	yes
Ammonium Sulfate	Sat'd	75	yes	no	yes
Ammonium Thiocyanate	Sat'd	75	yes	no	yes
Amyl Alcohol	Any	75	yes	yes	yes
Arsenic Acids	Any	75	yes	no	yes
Barium Sulfide	Sat'd	75	yes	no	yes
Black Liquor	Sat'd	75	yes	no	yes
Benzoic Acid	Sat'd	75	yes	no	yes
Brass Plating Solution	Any	75	yes	no	yes
Bromine Water	Sat'd	75	yes	no	yes
Butyl Alcohol	Any	75	yes	no	yes
Cadmium Plating Solution	Any	75	yes	no	yes
Calcium Bisulfite	Any	75	yes	no	yes
Calcium Chloride	Sat'd	75	yes	no	yes
Calcium Hypochlorite	Sat'd	75	yes	no	yes
Carbonic Acid	Sat'd	75	yes	no	yes
Casein	Sat'd	75	yes	no	yes
Castor Oil	Any	75	yes	yes	yes
Caustic Soda	35%	75	yes	no	yes
Caustic Soda	10%	75	yes	no	yes
Caustic Potash	35%	75	yes	no	yes
Caustic Potash	10%	75	yes	no	yes
Chlorine Water	Sat'd	75	yes	no	yes
Chromium Plating Solution	Any	75	yes	no	yes
Citric Acid	Sat'd	75	yes	no	yes
Copper Chloride (Cupric)	Sat'd	75	yes	no	yes
Copper Cyanide Plating Sol (High Speed)	Any	75	yes	no	yes
(with Alkali Cyanides)	Sat'd	75	yes	no	yes
Copper Sulfate	Sat'd	75	yes	no	yes
Coconut Oil	Sat'd	75	yes	yes	yes
Cottonseed Oil	Sat'd	75	yes	yes	yes
Disodium Phosphate	Sat'd	75	yes	no	yes
Ethyl Alcohol	Any	75	yes	no	yes
Ethylene Glycol	Any	75	yes	yes	yes
Ferric Chloride	45%	75	yes	no	yes
Ferrous Sulfate	Sat'd	75	yes	no	yes
Fluoboric Acid	Any	75	yes	no	yes
Formaldehyde	37%	75	yes	no	yes
Formic Acid	85%	75	yes	no	yes
Gallic Acid	Sat'd	75	yes	no	yes
Glucose	Any	75	yes	yes	yes
Glue	Any	75	yes	no	yes
Glycerine	Any	75	yes	yes	yes
Gold Plating Solution	Any	75	yes	no	yes
Hydrochloric Acid	10%	75	yes	no	yes
Hydrochloric Acid	21.5%	75	yes	no	yes
Hydrochloric Acid	37.5%	75	yes	no	yes
Hydrofluoric Acid	4%	75	yes	no	yes
Hydrofluoric Acid	10%	75	yes	no	yes
Hydrofluoric Acid	48%	75	yes	no	yes
Hydrogen Peroxide	30%	75	yes	no	yes
Hydrogen Sulfide	Sat'd	75	yes	no	yes
Hydroquinone	Any	75	yes	no	yes
Indium Plating Solution	Any	75	yes	no	yes
Lactic Acid	50%	75	yes	no	yes
Lactic Acid	Any	75	yes	no	yes

SOLUTIONS	CONC.	TEMP.	RECOMMENDED EXPOSURE		
			SPLASHING	LIQUID	FUMES
Lead Plating Solution	Any	75	yes	no	yes
Malic Acid	Any	75	yes	no	yes
Methyl Alcohol	Any	75	yes	no	yes
Mineral Oils	Any	75	yes	yes	yes
Nickel Acetate	Sat'd	75	yes	no	yes
Nickel Plating Solution		75	yes	no	yes
Nickel Salts	Sat'd	75	yes	no	yes
Nitric Acid	35%	75	yes	no	yes
Nitric Acid	40%	75	yes	no	yes
Nitric Acid	60%	75	yes	no	yes
Nitric Acid/ Hydrofluoric Acid	15%				
	4%	75	yes	no	yes
Nitric Acid/ Sodium Dichromate	16%				
	13%	75	yes	no	yes
	71%				
Oleic Acid	Any	75	yes	no	yes
Oxalic Acid	Sat'd	75	yes	no	yes
	Any	75	yes	no	yes
Phenol	Sat'd	75	yes	no	yes
Phosphoric Acid	75%	75	yes	no	yes
Phosphoric Acid	85%	75	yes	no	yes
Potassium Acid Sulfate	Sat'd	75	yes	no	yes
Potassium Antimonate	Sat'd	75	yes	no	yes
Potassium Bisulfite	Sat'd	75	yes	no	yes
Potassium Chloride	Sat'd	75	yes	no	yes
Potassium Cuprocyanide	Sat'd	75	yes	no	yes
Potassium Cyanide	Sat'd	75	yes	no	yes
Potassium Dichromate	Sat'd	75	yes	no	yes
Potassium Hypochlorite	Sat'd	75	yes	no	yes
Potassium Sulfide	Sat'd	75	yes	no	yes
Potassium Thiosulfate	Sat'd	75	yes	no	yes
Propyl Alcohol	Sat'd	75	yes	no	yes
Rhodium Plating Solution	Sat'd	75	yes	no	yes
Silver Plating Solution	Sat'd	75	yes	no	yes
Soaps	Any	75	yes	no	yes
Sodium Acid Sulfate	Sat'd	75	yes	no	yes
Sodium Antimonate	Sat'd	75	yes	no	yes
Sodium Bicarbonate	Sat'd	75	yes	no	yes
Sodium Bisulfite	Sat'd	75	yes	no	yes
Sodium Chloride	Sat'd	75	yes	no	yes
Sodium Cyanide	Sat'd	75	yes	no	yes
Sodium Dichromate	Sat'd	75	yes	no	yes
Sodium Hydroxide	10%	75	yes	no	yes
Sodium Hydroxide	35%	75	yes	no	yes
Sodium Hydroxide	73%	75	yes	no	yes
Sodium Hypochlorite	Sat'd	75	yes	no	yes
Sodium Hypochlorite	15%	75	yes	no	yes
Sodium Sulfide	Sat'd	75	yes	no	yes
Sodium Thiosulfate	Sat'd	75	yes	no	yes
Sulfuric Acid	15%	75	yes	no	yes
Sulfuric Acid	50%	75	yes	no	yes
Sulfuric Acid	70%	75	yes	no	yes
Sulfuric Acid	98%	75	yes	no	yes
Sulfurous Acid	2%	75	yes	no	yes
Sulfurous Acid	6%	75	yes	no	yes
Tannic Acid	Sat'd	75	yes	no	yes
Tartaric Acid	Sat'd	75	yes	no	yes
Tin Chloride Aqueous	Sat'd	75	yes	no	yes
Tin Plating Solution	Sat'd	75	yes	no	yes
Triethanolamine	Sat'd	75	yes	no	yes
Trisodium Phosphate	Sat'd	75	yes	no	yes
Water	Sat'd	75	yes	no	yes
White Liquor		75	yes	no	yes
Zinc Plating Solution		75	yes	no	yes
Zinc Sulfate	Sat'd	75	yes	no	yes

Technical Information

Ocal® Guide Specification:

Section 26 05 33 — Underground Ducts and Raceways for Electrical Systems: Conduit Systems for Use in Corrosive Environments

Part 1 — General

Part 2 — Products

1.1 Summary

- A. Section Includes: Furnishing, installation and assembly of PVC-coated electrical rigid metal conduit (ERMC) systems and stainless steel fittings.
- B. Related Sections
 - 1. Section 26 05 29 – Hangers and Supports for Electrical Systems

1.2 References

- A. National Electrical Manufacturers Association (NEMA)
 - 1. NEMA RN 1: Polyvinyl-Chloride (PVC) Externally Coated Galvanized Rigid Steel Conduit and Intermediate Metal Conduit
- B. National Fire Protection Association (NFPA)
 - 1. NFPA 70: National Electrical Code® (NEC®)
- C. American Society for Testing and Materials (ASTM):
 - 1. ASTM A 239: Standard Practice for Locating the Thinnest Spot in a Zinc (Galvanized) Coating on Iron or Steel Articles
- D. Underwriters Laboratories, Inc. (UL®)
 - 1. UL 6: Safety Standard for Rigid Metal Conduit
 - 2. UL 514B: Safety Standard for Fittings for Conduit and Outlet Boxes
- E. American National Standards Institute (ANSI)
 - 1. ANSI C80.1: American National Standard for Rigid Steel Conduit – Zinc Coated
- G. Steel Tube Institute of North America
 - 1. Guidelines for Installing Steel Conduit/Tubing

1.3 Submittals

- A. General: Submit in accordance with Section 01 33 00.
- B. Product Data
 - 1. Manufacturer's descriptive literature and product specifications for each product.
 - 2. Manufacturer's installation literature and training guide.
 - 3. Manufacturer's product drawings, when applicable.

1.4 Quality Assurance

- A. Manufacturer Qualifications: Products shall be free of defects in material and workmanship.
- B. Installer Qualifications: Installer shall be trained and certified based on the acceptable manufacturer's listed requirements.

2.1 General

- A. Furnish PVC-coated ERMC of size as indicated. If not indicated, the smallest trade size shall be ¾ in. The PVC-coated ERMC system shall include necessary PVC-coated fittings, boxes and covers to form a complete encapsulated system.

2.2 Manufacturers

- A. Acceptable Manufacturers: Thomas & Betts Corporation; 8155 T & B Blvd., Memphis, TN 38125. Tel: 901-252-5000. Web: www.tnb.com.
- B. Substitutions: Not permitted.
- C. Requests for substitutions will be considered in accordance with provisions of Section 01 25 00.

2.3 Materials/Components

A. PVC-COATED RIGID STEEL CONDUIT

The PVC-coated rigid steel conduit shall be hot-dip galvanized inside and out with hot-dip galvanized threads. The interior galvanizing shall be listed per UL 6. The exterior galvanizing shall be listed per UL 6 as primary corrosion protection. Thread protectors shall be used on the exposed threads of the PVC-coated conduit. PVC-coated ERMC steel conduit shall comply with UL 6, ANSI C80.1 and NEMA RN 1 standards without exception.

The PVC coating, in compliance with NEMA RN 1, shall be nominal 40 mils in thickness continuous over the entire length of the conduit except at the threads and be free of blisters, bubbles or pinholes. PVC shall be UL listed as a primary corrosion protection.

A blue urethane coating shall be uniformly and consistently applied to the interior of conduit. This internal coating shall be a nominal 2 mils thickness. All male threads on elbows and nipples shall be protected by this same application of urethane coating.

Coated couplings shall be used with coated conduit. The thickness of the coating on couplings shall be at least equal to the thickness of the coating on the conduit. Each coated coupling shall have a flexible PVC sleeve which extends from each end of the coupling and which will overlap the PVC coating on the conduit when the coupling has been installed on the conduit. The length of the sleeve extension(s) shall be at least equivalent to the nominal conduit size for sizes up through 2 in. For sizes 2–6 in., the length of the sleeve extension(s) shall be at least 2 in. The PVC sleeve shall be a nominal thickness of 40 mils in thickness. The inside diameter of the overlapping sleeve shall be less than the outside diameter of the PVC-coated conduit.

B. PVC-COATED RIGID ALUMINUM CONDUIT

The PVC-coated ERMC aluminum conduit prior to coating shall be UL listed. The exterior of the conduit shall have a PVC coating of a minimum thickness of nominal 40 mils.

Technical Information

Ocal® Guide Specification (continued):

A blue urethane coating shall be uniformly and consistently applied to the interior of conduit. This internal coating shall be a nominal 2 mils thickness. All male threads on elbows and nipples shall be protected by this same application of urethane coating.

Coated couplings shall be used with coated conduit. The thickness of the coating on couplings shall be at least equal to the thickness of the coating on the conduit. Each coated coupling shall have a flexible PVC sleeve which extends from each end of the coupling and which will overlap the PVC coating on the conduit when the coupling has been installed on the conduit. The length of the sleeve extension(s) shall be at least equivalent to the nominal conduit size for sizes up through 2 in. For sizes 2–6 in., the length of the sleeve extension(s) shall be at least 2 in.

The PVC sleeve shall be a nominal thickness of 40 mils in thickness. The inside diameter of the overlapping sleeve shall be less than the outside diameter of the PVC-coated conduit.

C. PVC-COATED ORDINARY LOCATION FITTINGS

PVC-coated ferrous and aluminum fittings for general service and corrosive locations must be UL listed. The PVC coating shall be minimum 40 mils in thickness and be free of blisters, bubbles or pinholes. Female threads on fittings shall be protected by application of urethane coating.

All female ends of PVC-coated conduit fittings shall have a flexible PVC sleeve which extends from the female ends of the fitting and which will overlap the PVC coating on the conduit when the fitting has been installed on the conduit. The length of the sleeve extension(s) shall be at least equivalent to the nominal conduit size for sizes up through 2 in. For sizes 2–6 in., the length of the sleeve extension(s) shall be at least 2 in. The PVC sleeve shall be a nominal thickness of 40 mils in thickness. The inside diameter of the overlapping sleeve shall be less than the outside diameter of the PVC-coated conduit.

1. The PVC coating on all form 8 covers shall form a gasket-like flange of at least 3/8 in. wide and minimum 40 mils covering the top of the fitting around the opening and the bottom of the cover/matting with the flange of the fitting. A blue urethane coating shall be uniformly and consistently applied to the interior, exterior and threads of all conduit bodies, including but not limited to form 8 and form 7 conduit bodies. This coating shall be a nominal 2 mils thickness. Stainless steel encapsulated screws shall be supplied with all form 7 and form 8 fittings.
2. Rigid hubs shall have a nominal 40 mils PVC coating thickness with a nominal 2 mils of blue urethane on interior and threads. The male threads and locknut shall remain uncoated.
3. Liquidtight fittings shall have an exterior PVC coating of a minimum thickness of nominal 40 mils.

D. PVC-COATED HAZARDOUS LOCATION FITTINGS

Hazardous location fittings prior to PVC coating must be UL listed. All female ends of PVC-coated conduit fittings shall have a flexible PVC sleeve which extends from the female ends of the fitting and which will overlap the PVC coating on the conduit when the fitting has been installed on the conduit. The length of the sleeve extension(s) shall be at least equivalent to the nominal conduit size for sizes up through 2 in. For sizes 2–6 in., the length of the sleeve extension(s) shall be at least 2 in. The PVC sleeve shall be a nominal thickness of 40 mils in thickness. The inside diameter

of the overlapping sleeve shall be less than the outside diameter of the PVC-coated conduit.

E. PVC-COATED STRUT, HANGERS AND CLAMPS

Right-angle beam clamps and U-bolts shall be specially formed and sized to fit snugly the outside diameter of the PVC-coated conduit. Support products such as ferrous strut, beam clamps, pipe straps, clamp back spacers, conduit clamp hangers and all-thread rods shall have a minimum 15-mil PVC coating by the manufacturer of the ERM conduit and system components.

F. STAINLESS STEEL FITTINGS

Stainless steel liquid-tight fittings shall be made of 304-grade stainless steel or better.

G. STAINLESS STEEL STRUT, HANGERS, ETC.

Stainless steel strut, beam clamps, pipe straps, clamp back spacers, conduit clamp hangers and all-thread rods shall be made of 304-grade stainless steel or better.

Part 3 — Execution

3.1 Examination

- A. The PVC-coated ERM and system components have been selected for use in an atmosphere considered to be corrosive for this project. The corrosive atmosphere is considered to be more damaging than merely the presence of moisture. Accordingly, conduit and the corresponding fittings for it must have PVC protection as described under Part 2 – Products. Conduit and fittings that are merely galvanized for this purpose are insufficient.

3.2 Preparation

- A. Preparation shall be done in accordance with manufacturer's printed instructions.

3.3 Installation

- A. Install in accordance with manufacturer's printed instructions and manufacturer's installation training.

3.4 Quality Control

- A. General: Comply with requirements of Section 01 45 13.

3.5 Manufacturer's Field Services

- A. Free on-site installation training course by company representative. This representative must conduct the on-site training course in order to qualify for the installation certificate. The time required for this training is estimated to be two (2) hours.
- B. After the on-site training installation, the representative shall then register the installer in his database and provide certification for installation.

END OF SECTION

Notes

1. Ocal® PVC-coated conduit and fittings are not recommended for use in areas where they will be exposed to sustained temperatures above 200 degrees Fahrenheit or exposed to fire. Prolonged exposure to heat greater than 200 degrees Fahrenheit or exposure to fire may cause the plastic coatings to release harmful emissions, posing a potential health hazard to persons subjected to such emissions.
2. If subjected to sustained flame or sustained heat above 400 degrees Fahrenheit, PVC will burn. PVC is self-extinguishing at room temperature.

Technical Information

Ocal® Recommended Installation Procedures

PVC-coated conduit is installed in much the same manner as conventional rigid galvanized steel conduit; however, certain precautions must be taken to protect the exterior coating and ensure satisfactory results. By following these guidelines and using the proper tooling, a damage-free installation can be achieved.

When an engineer has specified Ocal® PVC-coated conduit, the intent is for the total run to be PVC coated. There are no exceptions to this rule. This means from the beginning of the run to its completion and all in between, no exposed metal shall be allowed.

Clamping in a Yoke-Style Vise

The first step is the correct clamping of the PVC-coated conduit.

When you use a yoke-style vise, you should replace both the upper and lower jaw inserts with the specially designed Ocal® jaw vise adapters. These adapters provide greater clamping force and prevent the pipe from spinning during the threading process. (See Catalog No. JAWS23 on **page 57**).



Ocal Jaw Vise Adapters
JAWS23
See **page 57**

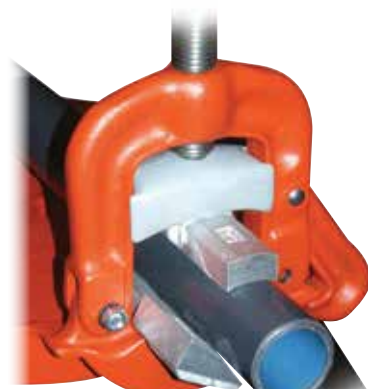

Clamping in a Chain-Style Vise

If a chain-style vise is used, the chain — as well as the jaw inserts — will tear the PVC coating when the threading force is applied.

To prevent this from happening, installers sometimes make “shells” from PVC pipe or standard rigid steel conduit that fit over the PVC-coated conduit. To save time and obtain more consistency, longer life and better protection, you can use the Ocal® half-shell clamps featured on **page 56**.

Available in trade sizes ½" to 6", Ocal® half-shell clamps are made from ductile iron for superior strength and durability. They feature a cross-hatched interior surface designed to safeguard the PVC coating while holding the conduit securely in a chain-style vise.



Chain-Style Vise
ROTH00076
See **page 56**

Half-Shell Clamp Sets
HLF-SHL-CLP-SET1
See **page 56**



Half-Shell Clamps
for conduit sizes ½" to 6"
HLF-SHL-CLP-
See **page 56**

Technical Information

Cutting with a Band Saw Cutter

A band saw cutter will cut the PVC coating flush with the end of the conduit. PVC material cut flush to the end of the conduit will not allow the die teeth to bite into the steel to start the threading process.

Therefore, before threading, you must remove approximately ¼" of the PVC coating from the end of the conduit. Using a knife, whittle in a pencil-sharpening style, cutting the coating from the conduit. A wire brush may also be used to remove PVC coating.

A band saw cutter usually will not cut the conduit at a "perfect" 90° angle (the accuracy of this cut depends heavily on the skill of the operator).

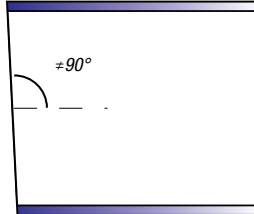

Cutting with a Roller-Style Cutter

Although most personnel in the field prefer a band saw cutter, a roller-style cutter is the recommended tool for cutting Ocal® PVC-coated conduit.

A roller-style cutter cuts the edge of the conduit at a bevel and removes ¼" of the coating at the same time. In addition, a roller-style cutter provides an exact 90° cut in relation to the conduit. No additional removal of PVC coating is necessary.

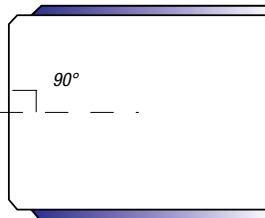

Steel Pipe Cutters
P70045C,
P70060C
See page 57



Technical Information

Manual and Hand-Held Threading

PVC-coated conduit has a larger O.D. than uncoated conduit. Standard dies will not clear the additional thickness. Hand-held as well as power threading devices require a die head for the correct size conduit. The standard die head is factory set for rigid conduit and will not fit over PVC coating. These die heads are available from Ocal®, machined for use with PVC-coated conduit. You can have standard dies machined as well.

If you have dies machined, you will need to adhere to the following procedure:

1. Remove the cover plate and the four die teeth.
2. Have the machinist remove 100 thousandths of an inch ($\frac{1}{10}$ ") from the throat and collar diameter of the die head.
3. Replace the dies and cover.

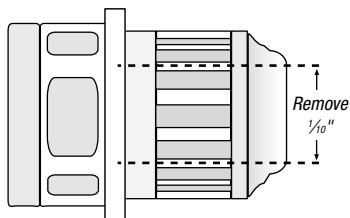

SUPER CUT Die Head Set
P70905C
See page 55

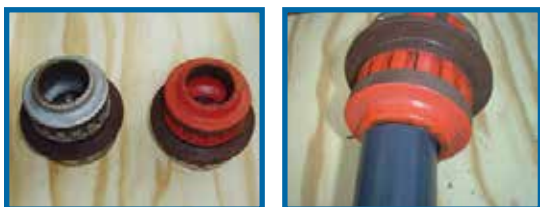

Throat & Collar Shown

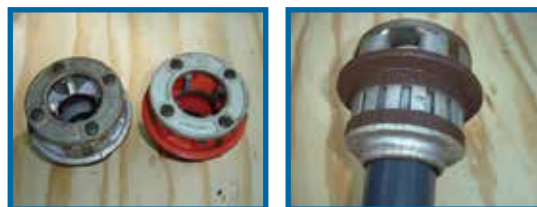

Cover Plate Shown



The die teeth are cutting tapered threads and will become clogged with PVC and metal shavings.



To prevent clogging, use a knife and score the conduit lengthwise from the point where the threads will end to where they begin. This will allow the PVC and metal shavings to fall into the throat of the die head.



Technical Information

Threading

Manual Hand-Held Threading

Manual, ratchet-style threaders, such as the Rothenberger SUPER CUT ratchet threader, are typically used for smaller size conduit. The ratchet knob indicates forward and reverse. Die heads snap in from both sides and lock in place.

Hand-Held Powered Threading

The Rothenberger MINI-COLLINS® is a heavy-duty hand-held power tool typically used for conduit up to 2" in diameter. Hand-held power threaders such as the Rothenberger SUPERTRONIC® 2000 are available with die heads for PVC-coated conduit. The Rothenberger MINI-COLLINS® uses Rothenberger SUPER CUT dies. Optional tool cases are available.



Rothenberger SUPERTRONIC® 2000
P71259C
See page 54



Ream the conduit with approved reamers. Spiral and straight-style reamers are both acceptable.



Rothenberger MINI-COLLINS®
R0TH00074
See page 55

The threads must be dressed per NEC® Article 300.6 [a]: "Where unusually corrosive elements require additional protection, it is recommended that threads be zinc coated with a hot dipped process or equivalent."

Use a good quality degreaser and apply Ocal® interior touch-up compound or KOPR-SHIELD®.



Ocal® Urethane Patching Compound
See page 59



KOPR-SHIELD®
See page 59

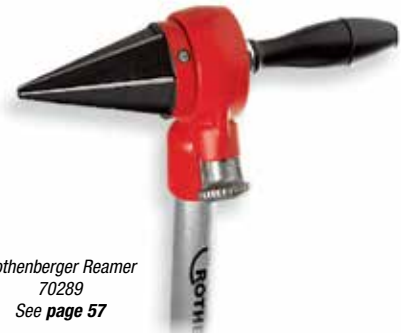

Rothenberger Reamer
70289
See page 57

Technical Information

Geared Threading

Geared threaders will thread 2½" through 6" PVC coated conduit. However, geared threaders are typically only used for 5" and 6" conduit. The cutting dies are adjustable and will not require pencil cutting the conduit.

The geared threader requires a clamp screw to secure the conduit, and the clamp screw will penetrate the PVC coating. Make certain the clamp screw is tight; otherwise, it will slip around the conduit and tear the coating. After the threading process is complete, touch up the penetrated area with Ocal® exterior PVC patching compound (see **pages 59–60**).

Ream the conduit and dress the threads as previously described.



Geared Threader ("Hog Head")



Rothenberger MINI-COLLINS®
ROTH00074
See **page 55**

Stationary Power Threading

Rothenberger RHINO®

The Rothenberger RHINO® threading machine featured on **page 54**, Catalog No. P00551C, which comes equipped with jaws for PVC-coated conduit up to 4", is the recommended choice for threading Ocal® PVC-coated conduit.

With the Rothenberger RHINO®, you won't need to pencil cut or score the PVC, because this machine uses a roller cutter and will remove ¼" of the PVC coating. Cuttings will fall onto the screen on the lower portion of the machine.

Machines that use centrifugal force (slap chucks) — other than the Rothenberger RHINO®, Catalog No. P00551C — to tighten the jaws around the conduit can be used, but only with shell clamps attached. These types of threaders will damage the PVC coating without the use of shell clamps.



Rothenberger RHINO®
P00551C
See **page 54**

Technical Information

Bending

Never use any type of lubricant on the shoes. Use rubbing alcohol to clean the shoe prior to bending.

Hand Bending

A standard hand bender can be used for saddles, offsets and conventional bending. For PVC-coated conduit, the next larger shoe size from the EMT size should be used. The chart below shows the catalog numbers of the hand benders on **page 53** and the corresponding size of PVC-coated conduit on which they should be used.

CAT. NO.	PVC-COATED CONDUIT SIZE
35220	1/2"
35225	3/4"
2424A8	1"



Hand Bender
See **page 53**



Chicago Bender



Ocal® Air-Cure
Patching Compounds
See **page 59**



Ocal® Heat-Cure Patch
See **page 60**

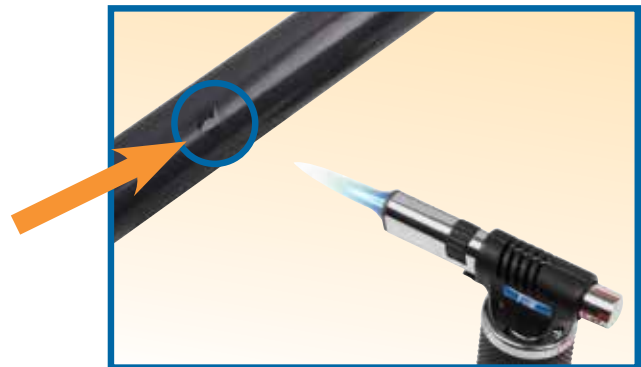

Ocal® Heat-Cure Patch offers a thicker consistency at higher ambient temperatures than standard air-cure compounds, ensuring better coverage and a more effective patch in warm weather applications.

Technical Information

Electric Bending

These machines are designed for bending 1/2" through 2" conduit. The shoes as well as the roller assembly should be of the design for use with PVC-coated conduit. Listed along with the Greenlee® electric bender on **page 53** are the bending accessories to equip the machine for PVC-coated conduit.

If you use conventional shoes on an electric bender, the shoes and each of the rollers in the roller assembly must be machined 60 thousandths. Some manufacturers use slide bars instead of a roller assembly, and these, too, must be machined 60 thousandths. Be sure to compensate for "spring back," since PVC coating often requires the setting to be off as much as 5°.

Hydraulic Bending

This is the preferred style of bending for 2 1/2" and larger size conduit. The shoe assembly should be of the design for PVC-coated conduit. The roller wheel and/or slide bar will accommodate PVC-coated conduit without the need for machining.

Note: Sequential bends can be manufactured by Ocal upon request.
5" and 6" conduit must be bent at the factory.



Greenlee® Model 555 Bender (left) and bending accessories for PVC-coated conduit (below) See **page 53**

Conduit & Fittings — Ocal® Corrosion-Resistant Conduit Systems



Shoe for Greenlee Hydraulic Bending Tool

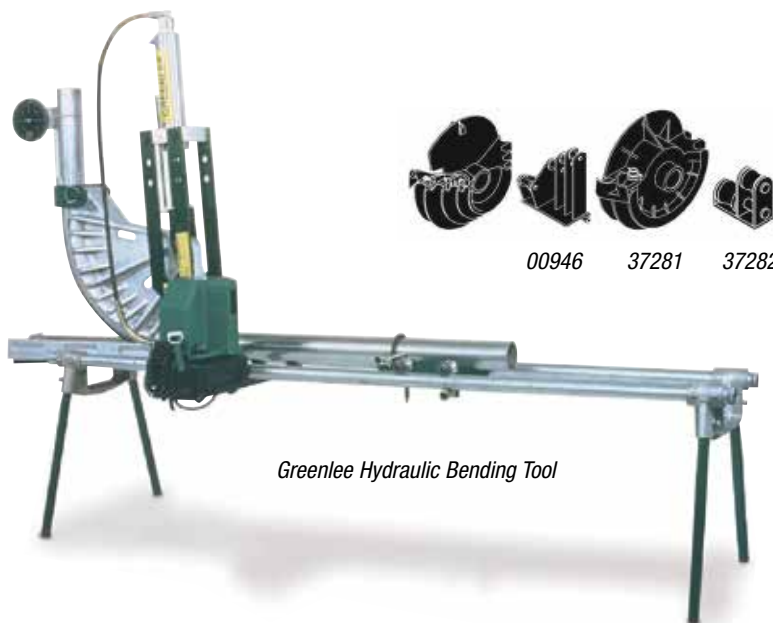

Greenlee Hydraulic Bending Tool



00946 37281 37282

Technical Information

NEMA Standards Publication No. RN 1–2005

Underwriter Laboratories, Inc. (UL®)

333 Pfingsten Road, Northbrook, IL 60062

UL® 6-2007 Safety Standard for Electrical Rigid Metal Conduit – Steel

Section 3 — External Coatings

3.1 Thickness

The thickness of polyvinyl chloride (PVC) coatings shall be a nominal .040 in. (1.02mm). The tolerance on the coating thickness shall be +.010 in. (.25mm) or -.005 in. (.13mm).

3.2 Coating Material

The PVC coating shall have the properties specified in **Table 3.1**.

Properties of PVC Coatings — Table 3.1

PROPERTY	MINIMUM REQUIREMENT	ASTM TEST METHOD
Hardness:		
Shore A	75	D 2240
Shore D	25	D 2240
Tensile Strength	2,000 psi	D 638
Elongation	200%	D 638
Dielectric Strength	325 volts per mil	D 149
Brittleness Temperature	5° F	D 1790

3.3 Application of Coating

3.3.1 Cleaning

The exterior surface that is to receive the coating shall be free of grease, oil, dirt and other extraneous matter. **The surface shall be cleaned in such a manner that the galvanized surface of the conduit is not harmed or eroded.**

3.3.2 Priming

The cleaned exterior surface shall be primed with an adhesive suitable for use with the PVC coating material to be applied.

3.3.3 Coating

The PVC material shall be applied in powder, plastisol or pellet form by a manufacturing method which will produce a finished product conforming to these standards.

3.4 Elbows

Coated elbows shall be used with coated conduit. The thickness of the coating on elbows shall be in accordance with Section 3.1.

3.5 Couplings

Coated couplings shall be used with coated conduit. The thickness of the coating on couplings shall be at least equal to the thickness of the coating on the conduit.

Each coated coupling shall have a flexible PVC sleeve which extends from each end of the coupling and which will overlap the PVC coating on the conduit when the coupling has been installed on the conduit.

The length of the sleeve extension(s) shall be at least equivalent to the nominal conduit size for sizes up through NPS 2 (53). For sizes NPS 2½ (63) through NPS 6 (155), the length of the sleeve extension(s) shall be at least 2 in. (50.8mm).

The PVC sleeve shall be a nominal thickness of .040 in. (1.02mm). The inside diameter (I.D.) of the overlapping sleeve shall be less than the outside diameter (O.D.) of the PVC-coated conduit.

3.6 Workmanship and Appearance

The PVC coating shall be free of blisters, bubbles and pinholes. The PVC coating shall be continuous over the entire length of the conduit except at the threads and shall be holiday-free at the time of manufacture.

A holiday is herein defined as an electrical discontinuity of less than 80,000 ohms equivalent resistance sensed with a cellulose sponge wet with a suitable electrolyte and measured with an appropriate low voltage direct-current instrument. A suitable electrolyte is a solution containing tap water, 3.0% salt (sodium chloride) and .5% liquid detergent.

The inside of the PVC-coated conduit, couplings and elbows shall be free of the PVC coating material.

All sleeve extensions shall be square cut.

3.7 Performance Requirements

Typical physical requirements for PVC-coated conduit are given in **Table 3.2**.

Typical Physical Properties of PVC-Coated Rigid Conduit and IMC — Table 3.2

PROPERTY	REQUIREMENT*	TEST METHOD
Abrasion Resistance	200 hours, no failure	ASTM G6
Bendability, Radius (at 73.4° ± 1.8° F)	9 in. (228.6mm)	ASTM G10
Artificial Weathering	Minimum 1,000 hours, no adverse effect	ASTM G153

* The above requirements are based on testing a .040 in. (1.02mm) PVC coating applied over NPS ¾ inch galvanized rigid steel conduit. See Section 1 for information on the ASTM test methods.

3.8 Adhesion

The adhesion of the PVC coating to the conduit shall be greater than the strength of the coating itself. This shall be determined by making two circumferential cuts, above ½ in. (12.7mm) apart, through the plastic to the substrate. A third cut shall be made perpendicular to and crossing the circumferential cuts. The edge of the plastic shall be carefully lifted with a knife to form a plastic tab. This tab shall be pulled perpendicular to the conduit with a pair of pliers. The plastic tab shall tear rather than any additional coating film separating from the substrate.

Catalog Number Index

CAT. NO.	PAGE NO.	CAT. NO.	PAGE NO.	CAT. NO.	PAGE NO.	CAT. NO.	PAGE NO.
0		37282.....	53	A120010T316SS.....	47	AP232SS.....	47
00573.....	53	380F-4X-.....	19	A120020T316SS.....	47	AP232SS6.....	47
00946.....	53	390-.....	19	A1200HS 10SS.....	47	AP235SQSS.....	47
1		4		A1200HS 20SS.....	47	AP235SQSS6.....	47
13158.....	55	470F-.....	19	A1200HS10T316SS.....	47	AP235SS.....	47
170F-.....	19	470SA-.....	19	A1200HS20T316SS.....	47	AP235SS6.....	47
170SA-.....	19	480F-4X-.....	19	A1202HS10SS.....	47	AW219SS.....	47
180F-4X-.....	19	490-.....	19	A1202HS10T316SS.....	47	AW219SS316.....	47
190-.....	19	5		A1202HS20SS.....	47	B	
1HMS1/2-.....	17	500-.....	49	A1202HS20T316SS.....	47	B100 1/2SS.....	48
1HMS1-.....	17	501-.....	49	A12A-.....	46	B100 1/4 SS.....	48
1HMS1-1/2-.....	17	502-.....	49	A12.....	46	B100 3/8 SS.....	48
1HMS1-1/4-.....	17	503-.....	49	AB100 1/4 SS.....	48	B1400 10SS.....	47
1HMS2-.....	17	508-.....	49	AB100 3/8 SS.....	48	B1400 20SS.....	47
1HMS2-1/2-.....	17	570F-.....	19	AB100 5/16SS.....	48	B140010T316SS.....	47
1HMS3/4-.....	17	570SA-.....	19	AB201SS.....	47	B140020T316SS.....	47
1HMS3-.....	17	580F-4X-.....	19	AB201SS316.....	47	BC10-.....	27
1HMS3-1/2-.....	17	590-.....	19	AB202SS.....	47	BC3-.....	27
1HMS4-.....	17	59912.....	54	AB202SS316.....	47	BC4-.....	27
2		6		AB203SS.....	47	BC5-.....	27
201-31879.....	59	670F-.....	19	AB203SS316.....	47	BC6-.....	27
201-31879-1.....	59	670SA-.....	19	AB204SS.....	47	BC7-.....	27
23818.....	53	680F-4X-.....	19	AB204SS316.....	47	BC8-.....	27
2424A8.....	53	690-.....	19	AB205SS.....	47	BC9-.....	27
270F-.....	19	7		AB205SS316.....	47	BG48-.....	27
270SA-.....	19	70289.....	57	AB206SS.....	47	BG68-.....	27
280F-4X-.....	19	8		AB206SS6C.....	47	BG88-.....	27
290-.....	19	870F-.....	19	AB207SS.....	47	BG98-.....	27
2HS1/2-.....	17	870SA-.....	19	AB207SS6C.....	47	BLB10-.....	27
2HS1-.....	17	880F-.....	19	AB213SS.....	47	BLB3-.....	27
2HS1-1/2-.....	17	889-.....	19	AB213SS316.....	47	BLB4-.....	27
2HS1-1/4-.....	17	89101.....	54	AB214SS.....	47	BLB5-.....	27
2HS2-.....	17	89102.....	54	AB214SS316.....	47	BLB6-.....	27
2HS2-1/2-.....	17	9		AB219SS.....	47	BLB7-.....	27
2HS3/4-.....	17	970F-.....	19	AB219SS316.....	47	BLB8-.....	27
2HS3-.....	17	970SA-.....	19	AB220SS.....	47	BLB9-.....	27
2HS3-1/2-.....	17	980F-.....	19	AB220SS316.....	47	BT10-.....	27
2HS4-.....	17	989-.....	19	AB225SS.....	47	BT3-.....	27
3		A		AB225SS316.....	47	BT4-.....	27
31355.....	58	A100 1/4 SS.....	48	AB227SS316.....	47	BT5-.....	27
31370.....	58	A100 3/8 SS.....	48	AB241 1/2SS.....	48	BT6-.....	27
35220.....	53	A100 5/16SS.....	48	AB241 1/4SS.....	48	BT7-.....	27
35225.....	53	A12-.....	46	AB241 3/8 SS.....	48	BT8-.....	27
370F-.....	19	A1200 10SS.....	47	AB241 5/16SS.....	48	BT9-.....	27
370SA-.....	19	A1200 20SS.....	47	AB241-1/2SS316.....	48	BUB10-.....	27
37279.....	53	0		AB241-1/4SS316.....	48	BUB3-.....	27
37281.....	53	A100 1/4 SS.....	48	AB241-3/8 SS316.....	48	BUB4-.....	27
		A100 3/8 SS.....	48	AP232SQSS.....	47	BUB5-.....	27
		A100 5/16SS.....	48	AP232SQSS6.....	47		
		A12-.....	46				
		A1200 10SS.....	47				
		A1200 20SS.....	47				

Catalog Number Index

Index

CAT. NO.	PAGE NO.	CAT. NO.	PAGE NO.	CAT. NO.	PAGE NO.	CAT. NO.	PAGE NO.
GUAD26-_____	41	GUAX59-_____	40	HUB1-1/2SA-_____	29	L300GR-TB_____	29
GUAD36-_____	41	GUAX69-_____	40	HUB1-1/4-_____	29	L350GRA-TB_____	29
GUAD49-_____	41			HUB1-1/4SA-_____	29	L350GR-TB_____	29
GUAL14-_____	41	H		HUB1SA-_____	29	L400GRA-TB_____	29
GUAL16-_____	41	H050GRSST_____	29	HUB2-_____	29	L400GR-TB_____	29
GUAL24-_____	41	H075GRSST_____	29	HUB2-1/2-_____	29	L500GRA-TB_____	29
GUAL26-_____	41	H100GRSST_____	29	HUB2-1/2SA-_____	29	L500GR-TB_____	29
GUAL36-_____	41	H104 1/2X12SS_____	48	HUB2SA-_____	29	L600GRA-TB_____	29
GUAL47-_____	41	H104 1/2X12SS316_____	48	HUB3/4-_____	29	L600GR-TB_____	29
GUAL49-_____	41	H104 3/8X12SS_____	48	HUB3/4SA-_____	29	LB107-_____	19, 21
GUAL59-_____	41	H104 3/8X6SS316_____	48	HUB3-_____	29	LB107SA-_____	19, 21
GUAL69-_____	41	H104-1/2X6SS6_____	48	HUB3-1/2-_____	29	LB108-_____	19, 21
GUAM14-_____	41	H104-1/2X6SSC_____	48	HUB3-1/2SA-_____	29	LB1089-_____	19, 21
GUAM16-_____	41	H104-3/8X12SS6_____	48	HUB3SA-_____	29	LB17-_____	19, 21
GUAM24-_____	41	H104-3/8X6SS_____	48	HUB4-_____	29	LB17SA-_____	19, 21
GUAM26-_____	41	H119 1/2SS_____	48	HUB4SA-_____	29	LB18-4X-_____	19, 21
GUAM36-_____	41	H119 1/4SS_____	48	HUB5-_____	29	LB19-_____	19, 21
GUAM47-_____	41	H119 3/8SS_____	48	HUB5SA-_____	29	LB27-_____	19, 21
GUAM69-_____	41	H119-1/2SS6_____	48	HUB6-_____	29	LB27SA-_____	19, 21
GUAN14-_____	41	H122-1/2-SS6_____	51	HUB6SA-_____	29	LB28-4X-_____	19, 21
GUAN16-_____	41	H122-1/4-SS6_____	51			LB29-_____	19, 21
GUAN24-_____	41	H122-3/8-SS6_____	51	J		LB37-_____	19, 21
GUAN26-_____	41	H125GRSST_____	29	J42_____	58	LB37SA-_____	19, 21
GUAN36-_____	41	H150GRSST_____	29	J442_____	58	LB38-4X-_____	19, 21
GUAN47-_____	41	H200GRSST_____	29	J460_____	58	LB39-_____	19, 21
GUAN59-_____	41	HLF-SHL-CLP1_____	56	J60_____	58	LB448-4X-_____	19, 21
GUAN69-_____	41	HLF-SHL-CLP1/2_____	56	JAWS23_____	57	LB47-_____	19, 21
GUAT14-_____	40	HLF-SHL-CLP1-1/2_____	56			LB47SA-_____	19, 21
GUAT16-_____	40	HLF-SHL-CLP1-1/4_____	56	L		LB49-_____	19, 21
GUAT24-_____	40	HLF-SHL-CLP2_____	56	L050GRA-TB_____	29	LB57-_____	19, 21
GUAT26-_____	40	HLF-SHL-CLP2_____	56	L050GRSST_____	29	LB57SA-_____	19, 21
GUAT36-_____	40	HLF-SHL-CLP3_____	56	L050GR-TB_____	29	LB58-4X-_____	19, 21
GUAT37-_____	40	HLF-SHL-CLP3/4_____	56	L075GRA-TB_____	29	LB59-_____	19, 21
GUAT47-_____	40	HLF-SHL-CLP3-1/2_____	56	L075GRSST_____	29	LB67-_____	19, 21
GUAT49-_____	40	HLF-SHL-CLP4_____	56	L075GR-TB_____	29	LB67SA-_____	19, 21
GUAT59-_____	40	HLF-SHL-CLP5_____	56	L100GRA-TB_____	29	LB68-4X-_____	19, 21
GUAT69-_____	40	HLF-SHL-CLP6_____	56	L100GRSST_____	29	LB69-_____	19, 21
GUAW14-_____	41	HLF-SHL-CLSET1_____	56	L100GR-TB_____	29	LB777-_____	19, 21
GUAW16-_____	41	HS107-SS_____	17	L125GRA-TB_____	29	LB777SA-_____	19, 21
GUAW24-_____	41	HS108-SS_____	17	L125GRSST_____	29	LB78-_____	19, 21
GUAW26-_____	41	HS109-SS_____	17	L125GR-TB_____	29	LB789-_____	19, 21
GUAX14-_____	40	HS110-SS_____	17	L150GRA-TB_____	29	LB87-_____	19, 21
GUAX16-_____	40	HS907-SS_____	17	L150GRSST_____	29	LB87SA-_____	19, 21
GUAX24-_____	40	HS908-SS_____	17	L150GR-TB_____	29	LB888-_____	19, 21
GUAX26-_____	40	HS909-SS_____	17	L200GRA-TB_____	29	LB889-_____	19, 21
GUAX36-_____	40	HS910-SS_____	17	L200GRSST_____	29	LB97-_____	19, 21
GUAX37-_____	40	HUB1/2-_____	29	L200GR-TB_____	29	LB97SA-_____	19, 21
GUAX47-_____	40	HUB1/2SA-_____	29	L250GRA-TB_____	29	LB98-_____	19, 21
GUAX49-_____	40	HUB1-_____	29	L250GR-TB_____	29	LB989-_____	19, 21
		HUB1-1/2-_____	29	L300GRA-TB_____	29		

Catalog Number Index

CAT. NO.	PAGE NO.	CAT. NO.	PAGE NO.	CAT. NO.	PAGE NO.	CAT. NO.	PAGE NO.
LBD012-	27	LL59-	19, 22	LR888-	19, 23	N	
LBD014-	27	LL67-	19, 22	LR889-	19, 23	NPL1/2X10-	13
LBD10900-	27	LL67SA-	19, 22	LR97-	19, 23	NPL1/2X10SA-	13
LBD1100-	27	LL68-4X-	19, 22	LR97SA-	19, 23	NPL1/2X12-	13
LBD2200-	27	LL69-	19, 22	LR989-	19, 23	NPL1/2X12SA-	13
LBD3300-	27	LL777-	19, 22	LRELL_X12-	15	NPL1/2X2-	13
LBD4400-	27	LL777SA-	19, 22	LRELL_X12-SA-	15	NPL1/2X21/2-	13
LBD5500-	27	LL78-	19, 22	LRELL_X15-	15	NPL1/2X21/2SA-	13
LBD6600-	27	LL789-	19, 22	LRELL_X15-SA-	15	NPL1/2X2SA-	13
LBD7700-	27	LL87-	19, 22	LRELL_X18-	15	NPL1/2X3-	13
LBD8800-	27	LL87SA-	19, 22	LRELL_X18-SA-	15	NPL1/2X31/2-	13
LBD9900-	27	LL888-	19, 22	LRELL_X24-	15	NPL1/2X31/2SA-	13
LBH10-	27	LL889-	19, 22	LRELL_X24-SA-	15	NPL1/2X3SA-	13
LBH100-	27	LL97-	19, 22	LRELL_X30-	15	NPL1/2X4-	13
LBH20-	27	LL97SA-	19, 22	LRELL_X30-SA-	15	NPL1/2X4SA-	13
LBH30-	27	LL989-	19, 22	LRELL_X36-	15	NPL1/2X5-	13
LBH40-	27	LR107-	19, 23	LRELL_X36-SA-	15	NPL1/2X5SA-	13
LBH50-	27	LR107SA-	19, 23	LRELL_X42-	15	NPL1/2X6-	13
LBH60-	27	LR1089-	19, 23	LRELL_X42-SA-	15	NPL1/2X6SA-	13
LBH70-	27	LR17-	19, 23	LRELL_X48-	15	NPL1/2X8-	13
LBH80-	27	LR17SA-	19, 23	LRELL_X48-SA-	15	NPL1/2X8SA-	13
LBH90-	27	LR18-4X-	19, 23	LRELL_X60-	15	NPL11/2X10-	13
LBH90-	27	LR19-	19, 23	LRELL_X60-SA-	15	NPL11/2X10SA-	13
LBY15-	28	LR27-	19, 23	LU17-	19, 25	NPL11/2X12-	13
LBY25-	28	LR27SA-	19, 23	LU18-4X-	19	NPL11/2X12SA-	13
LBY35-	28	LR28-4X-	19, 23	LU27-	19, 25	NPL11/2X2-	13
LBY45-	28	LR29-	19, 23	LU28-4X-	19	NPL11/2X21/2-	13
LBY55-	28	LR37-	19, 23	LU37-	19, 25	NPL11/2X21/2SA-	13
LL107-	19, 22	LR37SA-	19, 23	LU38-4X-	19	NPL11/2X2SA-	13
LL107SA-	19, 22	LR38-4X-	19, 23	LU448-4X-	19	NPL11/2X3-	13
LL1089-	19, 22	LR39-	19, 23	LU47-	19, 25	NPL11/2X31/2-	13
LL17-	19, 22	LR448-4X-	19, 23	LU57-	19, 25	NPL11/2X31/2SA-	13
LL17SA-	19, 22	LR47-	19, 23	LU58-4X-	19	NPL11/2X3SA-	13
LL18-4X-	19, 22	LR47SA-	19, 23	LU67-	19, 25	NPL11/2X4-	13
LL19-	19, 22	LR49-	19, 23	LU68-4X-	19	NPL11/2X4SA-	13
LL27-	19, 22	LR57-	19, 23	M			
LL27SA-	19, 22	LR57SA-	19, 23	MINE1/2-	49	NPL11/2X5-	13
LL28-4X-	19, 22	LR58-4X-	19, 23	MINE1-	49	NPL11/2X5SA-	13
LL29-	19, 22	LR59-	19, 23	MINE1-1/2-	49	NPL11/2X6-	13
LL37-	19, 22	LR67-	19, 23	MINE1-1/4-	49	NPL11/2X6SA-	13
LL37SA-	19, 22	LR67SA-	19, 23	MINE2-	49	NPL11/2X8-	13
LL38-4X-	19, 22	LR68-4X-	19, 23	MINE2-1/2-	49	NPL11/2X8SA-	13
LL39-	19, 22	LR69-	19, 23	MINE3/4-	49	NPL11/4X10-	13
LL448-4X-	19, 22	LR777-	19, 23	MINE3-	49	NPL11/4X10SA-	13
LL47-	19, 22	LR777SA-	19, 23	MINE3-1/2-	49	NPL11/4X12-	13
LL47SA-	19, 22	LR78-	19, 23	MINE4-	49	NPL11/4X12SA-	13
LL49-	19, 22	LR789-	19, 23			NPL11/4X2-	13
LL57-	19, 22	LR87-	19, 23			NPL11/4X21/2-	13
LL57SA-	19, 22	LR87SA-	19, 23			NPL11/4X21/2SA-	13
LL58-4X-	19, 22					NPL11/4X2SA-	13

Catalog Number Index

Index

CAT. NO.	PAGE NO.	CAT. NO.	PAGE NO.	CAT. NO.	PAGE NO.	CAT. NO.	PAGE NO.
NPL11/4X3-	13	NPL2X12SA-	13	NPL3X12-	13	P70159C	58
NPL11/4X31/2-	13	NPL2X21/2-	13	NPL3X12SA-	13	P70160C	58
NPL11/4X31/2SA-	13	NPL2X21/2SA-	13	NPL3X31/2-	13	P70161C	58
NPL11/4X3SA-	13	NPL2X3-	13	NPL3X31/2SA-	13	P70162C	58
NPL11/4X4-	13	NPL2X31/2-	13	NPL3X4-	13	P70849C	55
NPL11/4X4SA-	13	NPL2X31/2SA-	13	NPL3X4SA-	13	P70850C	55
NPL11/4X5-	13	NPL2X3SA-	13	NPL3X5-	13	P70905C	55
NPL11/4X5SA-	13	NPL2X4-	13	NPL3X5SA-	13	P70912C	55
NPL11/4X6-	13	NPL2X4SA-	13	NPL3X6-	13	P70913C	55
NPL11/4X6SA-	13	NPL2X5-	13	NPL3X6SA-	13	P70914C	55
NPL11/4X8-	13	NPL2X5SA-	13	NPL3X8-	13	P70915C	55
NPL11/4X8SA-	13	NPL2X6-	13	NPL3X8SA-	13	P71259C	54
NPL1X10-	13	NPL2X6SA-	13	NPL4X10-	13	PAR1/2-	16
NPL1X10SA-	13	NPL2X8-	13	NPL4X10SA-	13	PAR1-	16
NPL1X12-	13	NPL2X8SA-	13	NPL4X12-	13	PAR1-1/2-	16
NPL1X12SA-	13	NPL3/4X10-	13	NPL4X12SA-	13	PAR1-1/4-	16
NPL1X2-	13	NPL3/4X10SA-	13	NPL4X4-	13	PAR2-	16
NPL1X21/2-	13	NPL3/4X12-	13	NPL4X4SA-	13	PAR2-1/2-	16
NPL1X21/2SA-	13	NPL3/4X12SA-	13	NPL4X5-	13	PAR3/4-	16
NPL1X2SA-	13	NPL3/4X2-	13	NPL4X5SA-	13	PAR3-	16
NPL1X3-	13	NPL3/4X21/2-	13	NPL4X6-	13	PAR3-1/2-	16
NPL1X31/2-	13	NPL3/4X21/2SA-	13	NPL4X6SA-	13	PAR4-	16
NPL1X31/2SA-	13	NPL3/4X2SA-	13	NPL4X8-	13	PATCHG-B	59
NPL1X3SA-	13	NPL3/4X3-	13	NPL4X8SA-	13	PATCHG-G	59
NPL1X4-	13	NPL3/4X31/2-	13	NPL5X10-	13	PATCHG-W	59
NPL1X4SA-	13	NPL3/4X31/2SA-	13	NPL5X10SA-	13	PATCHB	59
NPL1X5-	13	NPL3/4X3SA-	13	NPL5X12-	13	PATCHG	59
NPL1X5SA-	13	NPL3/4X4-	13	NPL5X12SA-	13	PATCHW	59
NPL1X6-	13	NPL3/4X4SA-	13	NPL5X5-	13	PATCHT-B	60
NPL1X6SA-	13	NPL3/4X5-	13	NPL5X5SA-	13	PATCHT-G	60
NPL1X8-	13	NPL3/4X5SA-	13	NPL5X6-	13	PATCHT-W	60
NPL1X8SA-	13	NPL3/4X6-	13	NPL5X6SA-	13		
NPL21/2X10-	13	NPL3/4X6SA-	13	NPL5X8-	13		
NPL21/2X10SA-	13	NPL3/4X8-	13	NPL5X8SA-	13		
NPL21/2X12-	13	NPL3/4X8SA-	13	NPL6X10-	13		
NPL21/2X12SA-	13	NPL31/2X10-	13	NPL6X10SA-	13		
NPL21/2X31/2-	13	NPL31/2X10SA-	13	NPL6X12-	13		
NPL21/2X31/2SA-	13	NPL31/2X12-	13	NPL6X12SA-	13		
NPL21/2X4-	13	NPL31/2X12SA-	13	NPL6X5-	13		
NPL21/2X4SA-	13	NPL31/2X4-	13	NPL6X5SA-	13		
NPL21/2X5-	13	NPL31/2X4SA-	13	NPL6X6-	13		
NPL21/2X5SA-	13	NPL31/2X5-	13	NPL6X6SA-	13		
NPL21/2X6-	13	NPL31/2X5SA-	13	NPL6X8-	13		
NPL21/2X6SA-	13	NPL31/2X6-	13	NPL6X8SA-	13		
NPL21/2X8-	13	NPL31/2X6SA-	13				
NPL21/2X8SA-	13	NPL31/2X8-	13				
NPL2X10-	13	NPL31/2X8SA-	13				
NPL2X10SA-	13	NPL3X10-	13				
NPL2X12-	13	NPL3X10SA-	13				

P			
P00551C	54		
P20305C	54		
P70045C	57		
P70060C	57		

R			
RA1/2-	16		
RA1-	16		
RA1-1/2-	16		
RA1-1/4-	16		
RA2-	16		
RA2-1/2-	16		
RA3/4-	16		
RA3-	16		
RA3-1/2-	16		
RA4-	16		
RE106-G	31		
RE107-G	31		
RE108-G	31		
RE21-G	31		
RE31-G	31		
RE32-G	31		
RE41-G	31		

Catalog Number Index

CAT. NO.	PAGE NO.	CAT. NO.	PAGE NO.	CAT. NO.	PAGE NO.	CAT. NO.	PAGE NO.
RE42-G	31	S232GFI-	37	ST190-	34	ST490G-	34
RE43-G	31	S322G-	37	ST190G-	34	ST490SA-	34
RE51-G	31	SC4-KIT	38	ST190SA-	34	ST4G-	34
RE52-G	31	SC65	38	ST1G-	34	ST4SA-	34
RE53-G	31	SEAL-A3	45	ST1SA-	34	STE050-	35
RE54-G	31	SEALKIT-A4	45	ST2-	34	STE075-	35
RE61-G	31	SPAB227SS	47	ST2-1/2-	34	STE100-	35
RE62-G	31	SPRAY-B	59	ST2-1/245-	34	STE125-	35
RE63-G	31	SPRAY-G	59	ST2-1/245G-	34	STE150-	35
RE64-G	31	SPRAY-W	59	ST2-1/290-	34	STE200-	35
RE65-G	31	SS1/2-	50	ST2-1/290G-	34	STE250-	35
RE73-G	31	SS1-	50	ST2-1/290SA-	34	STE300-	35
RE74-G	31	SS1-1/2-	50	ST2-1/2G-	34	STE350-	35
RE75-G	31	SS1-1/4-	50	ST2-1/2SA-	34	STE400-	35
RE76-G	31	SS2-	50	ST245-	34	STEX075-	38
RE83-G	31	SS2-1/2-	50	ST245G-	34	STEX100-	38
RE84-G	31	SS3/4-	50	ST290-	34	STEX125-	38
RE85-G	31	SS3-	50	ST290G-	34	STEX150-	38
RE86-G	31	SS3-1/2-	50	ST290SA-	34	STEX200-	38
RE87-G	31	SS4-	50	ST2G-	34	STEX250-	38
RE96-G	31	SS5-	50	ST2SA-	34	STEX300-	38
RE97-G	31	ST050-462-	35	ST3/4-	34	STEX350-	38
RE98-G	31	ST1/2-	34	ST3/445-	34	STEX400-	38
REC01210-	31	ST1/245-	34	ST3/445G-	34	STG1-	29
REC108-	31	ST1/245G-	34	ST3/490-	34	STG10-	29
REC21-	31	ST1/290-	34	ST3/490G-	34	STG11-	29
REC31-	31	ST1/290G-	34	ST3/490SA-	34	STG12-	29
REC32-	31	ST1/290SA-	34	ST3/4G-	34	STG2-	29
REC42-	31	ST1/2G-	34	ST3/4SA-	34	STG3-	29
REC43-	31	ST1/2SA-	34	ST3/8-	34	STG4-	29
REC52-	31	ST1-	34	ST3/845-	34	STG5-	29
REC53-	31	ST1-1/2-	34	ST3/845G-	34	STG6-	29
REC54-	31	ST1-1/245-	34	ST3/890-	34	STG7-	29
REC602-	31	ST1-1/245G-	34	ST3/890G-	34	STG8-	29
REC603-	31	ST1-1/290-	34	ST3/890SA-	34	STG9-	29
REC604-	31	ST1-1/290G-	34	ST3/8G-	34	STTB1-	30
REC605-	31	ST1-1/290SA-	34	ST3/8SA-	34	STTB10-	30
REC75-	31	ST1-1/2G-	34	ST3-	34	STTB11-	30
REC86-	31	ST1-1/2SA-	34	ST345-	34	STTB12-	30
REC97-	31	ST1-1/4-	34	ST345G-	34	STTB2-	30
ROTH00074	55	ST1-1/445-	34	ST390-	34	STTB3-	30
ROTH00076	56	ST1-1/445G-	34	ST390G-	34	STTB4-	30
ROTH00117	55	ST1-1/490-	34	ST390SA-	34	STTB5-	30
ROTH00119	55	ST1-1/490G-	34	ST3G-	34	STTB6-	30
ROTH00548	54	ST1-1/490SA-	34	ST3SA-	34	STTB7-	30
ROTH02385	54	ST1-1/4G-	34	ST4-	34	STTB8-	30
	S	ST1-1/4SA-	34	ST445-	34	STTB9-	30
S1002G-	37	ST145-	34	ST445G-	34	STTTB1-	30
S232-	37	ST145G-	34	ST490-	34	STTTB2-	30

Catalog Number Index

Index

CAT. NO.	PAGE NO.	CAT. NO.	PAGE NO.	CAT. NO.	PAGE NO.	CAT. NO.	PAGE NO.
STTTB3-_____	30	TB18-4X-_____	19, 25	U			
STTTB4-_____	30	TB19-_____	19, 25	U501SS_____	48	X207SS_____	47
STTTB5-_____	30	TB27-_____	19, 25	U502SS_____	48	X27-_____	19, 26
STTTB6-_____	30	TB27SA-_____	19, 25	UB1/2-_____	16	X27SA-_____	19, 26
STX050-462-_____	38	TB28-4X-_____	19, 25	UB1-_____	16	X28-4X-_____	19, 26
STX050-464-_____	38	TB29-_____	19, 25	UB1-1/2-_____	16	X29-_____	19, 26
STX400-484-_____	38	TB37-_____	19, 25	UB1-1/4-_____	16	X37-_____	19, 26
STX400-485-_____	38	TB37SA-_____	19, 25	UB2-_____	16	X37SA-_____	19, 26
T				UB2-1/2-_____	16	X38-4X-_____	19, 26
T107-_____	19, 24	TB38-4X-_____	19, 25	UB3/4-_____	16	X39-_____	19, 26
T107SA-_____	19, 24	TB39-_____	19, 25	UB3-_____	16	X448-4X-_____	19, 26
T1089-_____	19, 24	TB448-4X-_____	19, 25	UB3-1/2-_____	16	X47-_____	19, 26
T17-_____	19, 24	TB47-_____	19, 25	UB4-_____	16	X47SA-_____	19, 26
T17SA-_____	19, 24	TB47SA-_____	19, 25	UB5-_____	16	X57-_____	19, 26
T18-4X-_____	19, 24	TB49-_____	19, 25	UB6-_____	16	X57SA-_____	19, 26
T19-_____	19, 24	TB57-_____	19, 25	UNF012-_____	39	X58-4X-_____	19, 26
T27-_____	19, 24	TB57SA-_____	19, 25	UNF014-_____	39	X67-_____	19, 26
T27SA-_____	19, 24	TB58-4X-_____	19, 25	UNF1005-_____	39	X67SA-_____	19, 26
T28-4X-_____	19, 24	TB67-_____	19, 25	UNF105-_____	39	X68-4X-_____	19, 26
T29-_____	19, 24	TB67SA-_____	19, 25	UNF205-_____	39	XJG104-_____	33
T37-_____	19, 24	TB68-4X-_____	19, 25	UNF305-_____	39	XJG108-_____	33
T37SA-_____	19, 24	TCC1-_____	12	UNF405-_____	39	XJG1208-_____	33
T38-4X-_____	19, 24	TCC10-_____	12	UNF505-_____	39	XJG24-_____	33
T39-_____	19, 24	TCC12-_____	12	UNF605-_____	39	XJG28-_____	33
T448-4X-_____	19, 24	TCC14-_____	12	UNF705-_____	39	XJG34-_____	33
T47-_____	19, 24	TCC2-_____	12	UNF805-_____	39	XJG38-_____	33
T47SA-_____	19, 24	TCC3-_____	12	UNF905-_____	39	XJG44-_____	33
T49-_____	19, 24	TCC4-_____	12	UNY014-_____	39	XJG48-_____	33
T57-_____	19, 24	TCC5-_____	12	UNY1005-_____	39	XJG54-_____	33
T57SA-_____	19, 24	TCC6-_____	12	UNY105-_____	39	XJG58-_____	33
T58-4X-_____	19, 24	TCC7-_____	12	UNY205-_____	39	XJG64-_____	33
T59-_____	19, 24	TCC8-_____	12	UNY305-_____	39	XJG68-_____	33
T67-_____	19, 24	TCC9-_____	12	UNY405-_____	39	XJG74-_____	33
T67SA-_____	19, 24	THR1/2X10-_____	48	UNY505-_____	39	XJG78-_____	33
T68-4X-_____	19, 24	THR1/2X3-_____	48	UNY605-_____	39	XJG84-_____	33
T69-_____	19, 24	THR1/2X6-_____	48	UNY705-_____	39	XJG88-_____	33
T77-_____	19, 24	THR1/4X10-_____	48	UNY805-_____	39	XJG94-_____	33
T77SA-_____	19, 24	THR3/8X10-_____	48	UNY905-_____	39	XJG98-_____	33
T78-_____	19, 24	THR3/8X3-_____	48	URETHANEPATCH_____	59		
T789-_____	19, 24	THR3/8X6-_____	48	W			
T87-_____	19, 24	TS102-SS_____	17	WLGFFS-_____	37		
T87SA-_____	19, 24	TS103-SS_____	17	WLRD1-_____	37		
T88-_____	19, 24	TS104-SS_____	17	WT-PTORCH_____	60		
T889-_____	19, 24	TS105-SS_____	17	X			
T97-_____	19, 24	TS106-SS_____	17	X17-_____	19, 26		
T97SA-_____	19, 24	TS902-SS_____	17	X17SA-_____	19, 26		
T989-_____	19, 24	TS903-SS_____	17	X18-4X-_____	19, 26		
TB17-_____	19, 25	TS904-SS_____	17	X19-_____	19, 26		
TB17SA-_____	19, 25	TS905-SS_____	17				
		TS906-SS_____	17				

A Global Leader in Innovative...



Wire & Cable Management

Carlion® *Catamount*® *EZCODE*® *Kindorf*® *red•dot*® *Steel City*®
Superstrut® *T&B Cable Tray* *Ty-Duct*® *Ty-Rap*®



Cable Protection Systems

Adaptaflex® **Carlion**® *Harnessflex*® *KOPEX-EX*® *Ocal*®
PMA® *red•dot*® *Steel City*® *T&B Fittings*®



Power Connection & Control

Blackburn® **CYBEREX**® *elastimold*® **FISHER PIERCE**® **HiTech**®
HOMAC® **JENNINGS** TECHNOLOGY® **JOSLYN**® *Pos-E-Kon*® *Russellstoll*® *Sta-Kon*®



Safety Technology

AMERACE® **Current Technology**® **EMERGI-LITE**®
Hazlux® **JOSLYN**® *Lightalarms*®

Thomas & Betts

www.tnb.com

Visit the T&B world of electrical product solutions

Visit our web site for more information about Thomas & Betts solutions and our newest products. For a user-friendly catalog and competitive part number search, application and technical support and other useful information, go to:

www.tnb.com

Industry codes and specifications

Thomas & Betts products meet or exceed applicable industry specifications or codes which are detailed in the appropriate T&B product literature.



Online CAD library

Thomas & Betts offers free download of two- and three-dimensional CAD models of many of its products in more than 90 native CAD formats at: www.tnb.com/cadlibrary

American Recovery and Reinvestment Act (ARRA)



Get certification letters for compliant products online at:

www.tnb.com/ARRA

Thomas & Betts Corporation

8155 T&B Boulevard
Memphis, TN 38125
901.252.8000

www.tnb.com

© 2013 Thomas & Betts Corporation. All rights reserved.
Greenlee, Rhino, Mini-Collins, Supertronic, and Kopr-Shield are the property of their respective owners.

Printed in the U.S.A. 02/13/5M CAT23

United States

Thomas & Betts Corporation
Electrical Division Headquarters
8155 T&B Boulevard
Memphis, TN 38125
Phone: 901.252.8000
Fax: 901.252.1354
Technical Services:
888.862.3289
Customer Service:
1.800.816.7809
Email: elec_custserv@tnb.com

Canada

Thomas & Betts Ltd
700 Avenue Thomas
St.-Jean-sur-Richelieu
Quebec J2X 2M9
Phone: 450.347.5318
Fax: 450.347.1976

Latin America

Mexico: 01-800-TNB-HELP
Central America & Caribbean:
+52.81.8329.7707
South America:
+52.81.8329.7643
Email: servicioalcliente@tnb.com

Europe/Africa

T&B European Centre
200 Chaussée de Waterloo
B-1640 Rhode-St-Genèse
Belgium
Phone: +32.235.98200
Email: europe_inquiry@tnb.com

Middle East

Thomas & Betts Ltd
PO Box 54567
Office 107 5EA East Wing
Dubai Airport Free Zone
Dubai
United Arab Emirates
Phone: +9714.609.1635
Fax: +9714.609.1636
Email: me_ex_inquiry@tnb.com

Asia Pacific

Thomas & Betts Asia Pte Ltd
10 Ang Mo Kio Street 65
#06-07 Techpoint
Singapore 569059
Phone: +65.6720.8828
Fax: +65.6720.8780
Email: asia_inquiry@tnb.com

Thomas & Betts