

INSTALLATION MANUAL

WIRED REMOTE CONTROLLER
For authorized service personnel only.

English

MANUEL D'INSTALLATION

TÉLÉCOMMANDE AVEC FIL
Uniquement réservé aux techniciens agréés.

Français

MANUAL DE INSTALACIÓN

MANDO A DISTANCIA CABLEADO
Sólo para personal de servicio autorizado.

Español

UTY-RNKU

INSTALLATION MANUAL

PART NO. 9373328179
WIRED REMOTE CONTROLLER

Contents

1. SAFETY PRECAUTIONS	2
2. MAIN UNIT AND ACCESSORIES	3
3. ELECTRICAL REQUIREMENT	3
4. SELECTING AN INSTALLATION LOCATION	
4.1. Dimensions	3
4.2. Name of parts	3
5. INSTALLING THE REMOTE CONTROLLER	
5.1. Installation	4
5.2. Setting the DIP switch	5
5.3. Connection of Remote Controller Cable	5
6. INSTALLATION METHODS	
6.1. Group control	6
6.2. Dual remote control	6
7. TURNING ON THE POWER	7
8. SETTING THE ROOM TEMPERATURE DETECTION LOCATION	7
9. ADDRESS SETTING	7
10. FUNCTION SETTING	8
11. ADMINISTRATIVE INDOOR UNIT SETTING	9
12. TEST RUN	10
13. ERROR CODE DISPLAY	10
14. GENERAL SPECIFICATIONS	10

1. SAFETY PRECAUTIONS

- The “SAFETY PRECAUTION” indicated in this manual contain important information pertaining to your safety. Be sure to observe them.
- For details of the operation methods, refer to the operating manual.
- Request the user to keep this manual on hand for future use, such as for relocating or repairing the unit.

 WARNING	This mark indicates procedures which, if improperly performed, might lead to the death or serious injury of the user.
Perform electrical work by an authorized service personnel in accordance with this manual and the electrical wiring regulations or implementation regulations of the country. Also do not install this unit by yourself. Improper electric work will cause electric shock or a fire.	
Perform installation work in accordance with this manual. Request an authorized service personnel to perform installation work. Do not install this unit by yourself. Improper installation will cause injury, electric shock, fire, etc.	
In the event of a malfunction (burning smell, etc.), immediately stop operation, turn off the electrical breaker, and consult authorized service personnel.	
Install a leakage circuit breaker to power supply cable in accordance with the related laws and regulations and electric company standards.	
Use a power source exclusively for this unit. Never share the power source with other electrical equipment. Doing so will cause fire and electric shock.	

Do not install the unit in the following areas:
<ul style="list-style-type: none"> • Do not install the unit near a source of heat, steam, or flammable gas. • Area filled with mineral oil or containing a large amount of splashed oil or steam, such as a kitchen. It will deteriorate plastic parts, causing the parts to fail or the unit to leak water. • Area that generates substances that adversely affect the equipment, such as sulfuric gas, chlorine gas, acid, or alkali. It will cause the copper pipes and brazed joints to corrode, which can cause refrigerant leakage. • Area containing equipment that generates electromagnetic interference. It will cause the control system to malfunction, preventing the unit from operating normally. • Area that can cause combustible gas to leak, contains suspended carbon fibers or flammable dust, or volatile inflammables such as paint thinner or gasoline. If gas leaks and settles around the unit, it can cause a fire. • Do not use the unit for special purposes, such as storing food, raising animals, growing plants, or preserving precision devices or art objects. It can degrade the quality of the preserved or stored objects. • Install the unit in a well-ventilated place avoiding rains and direct sunlight.





Do not operate this unit when your hands are wet. Touching the unit with wet hands will cause an electric shock.

If children may approach the unit, take preventive measures so that they cannot reach the unit.

 CAUTION	This mark indicates procedures which, if improperly performed, might possibly result in personal harm to the user or damage to property.
When detecting the room temperature using the remote controller, please set up the remote controller according to the following conditions. If the remote controller is not well set, the correct room temperature will not be detected, and thus the abnormal conditions like “not cool” or “not heat” will occur even if the air-conditioner is running normally. :	
<ul style="list-style-type: none"> • A location with an average temperature for the room being air conditioned. • Not directly exposed to the outlet air from the air-conditioner. • Out of direct sunlight. • Away from the influence of other heat sources. 	
Pay abundant care when transporting this unit because it is a precision device. Improper transportation will cause trouble.	
Do not touch the switches with sharp objects. Doing so will cause injury, trouble, or electric shock.	
Do not expose this unit directly to water. Doing so will cause trouble, electric shock, or heating.	
Do not set vessels containing a liquid on this unit. Doing so will cause heating, fire, or electric shock.	
Dispose of the packing materials safely. Tear and dispose of the plastic packing bags so that children cannot play with them. There is the danger of suffocation if children play with the original plastic bags.	
Do not insert articles into the slit parts of this unit. Doing so will cause trouble, heating, or electric shock.	

2. MAIN UNIT AND ACCESSORIES

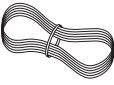
The following installation parts are supplied. Use them as required.

Name and Shape	Q'ty	Application
Wired remote controller 	1	Main unit
Installation manual 	1	This manual
Operating manual 	1	Instruction book for operation
Remote controller cable 33 ft. (10 m) 	1	For connecting the remote controller
Screw (M4 × 16mm) 	2	For installing the remote controller
Binder 	1	For remote controller and remote controller cable binding

3. ELECTRICAL REQUIREMENT

When connecting the remote controller use the following wiring.

Use	Size	Wire type	Remarks
Remote controller cable	0.33 mm ² (22AWG)	Polar 3 core Twisted pair	Use sheathed PVC cable.

4. SELECTING AN INSTALLATION LOCATION

4.1. Dimensions

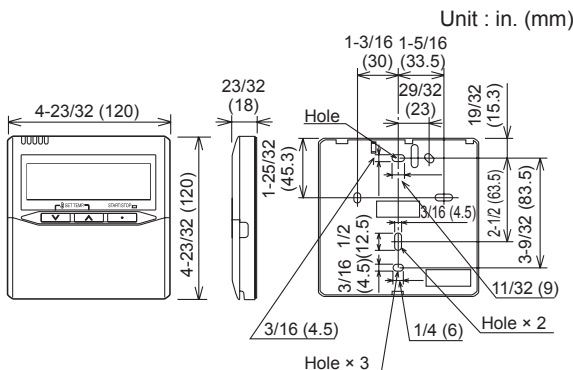





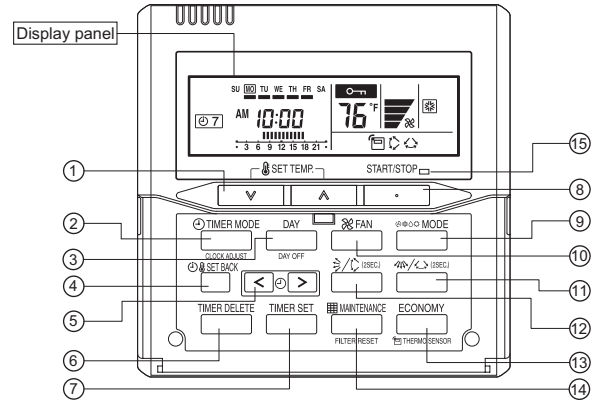



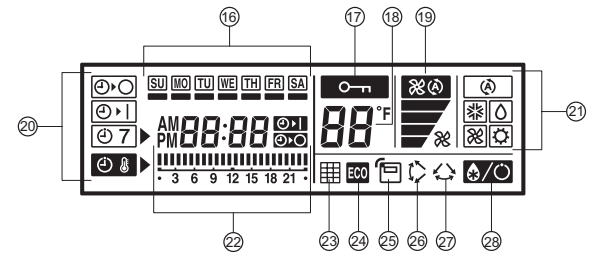



4.2. Name of parts

• With cover open



• Display panel



- ① “ SET TEMP. ” (Set Temperature Button)
- ② “ TIMER MODE / CLOCK ADJUST” (Timer Mode/Clock Adjust Button)
- ③ “DAY / DAY OFF” (Day/Day OFF Button)
- ④ “ SET BACK” (Set Back Button)
- ⑤ “< ”, “ >” (Set Time Button)
- ⑥ “TIMER DELETE” (Timer Delete Button)
- ⑦ “TIMER SET” (Timer Set Button)
- ⑧ “START/STOP” (Start/Stop Button)
- ⑨ “ MODE” (Mode Button)
- ⑩ “ FAN” (Fan Control Button)
- ⑪ “ ” (Horizontal airflow direction and swing Button)
- ⑫ “ ” (Vertical airflow direction and swing Button)
- ⑬ “ECONOMY /  THERMO SENSOR” (Economy/Thermo Sensor Button)
- ⑭ “ MAINTENANCE / FILTER RESET” (Maintenance/Filter Reset Button)
- ⑮ Operation Lamp
- ⑯ Day Display
- ⑰ Operation Lock Display
- ⑱ Temperature Display
- ⑲ Fan Speed Display
- ⑳ Timer Mode Display
- ㉑ Operation Mode Display
- ㉒ Timer and Clock Display
- ㉓ Filter Display
- ㉔ Economy Display
- ㉕ Thermo Sensor Display
- ㉖ Vertical Swing Display
- ㉗ Horizontal Swing Display
- ㉘ Defrost Display

5. INSTALLING THE REMOTE CONTROLLER

WARNING

Always use the accessories and specified installation work parts. Check the state of the installation parts. Not using the specified parts will cause units to fall off, water leakage, electric shock, fire, etc.

Install at a place that can withstand the weight of the unit and install positively so that the unit will not topple or fall.

When installing this unit, make sure that there are no children nearby. Otherwise, injury or electric shock could result.

After installing this unit, perform the test run to confirm that the unit is operating properly. Then, explain the operation of this unit to the customer.

Before starting installation work, turn off the power of this unit and the connection destination. Do not turn on the power again until installation is completed. Otherwise, it will cause electric shock or fire.

Use the accessories or specified power supply cable and remote controller cables. Do not modify power supply cable and remote controller cables other than those specified, do not use extension cords, and do not use independent branch wiring. Overcurrent may cause electric shock or fire.

Install the remote controller cables securely to the terminal block. Confirm that external force is not applied to the wire. Use remote controller cables made of the specified wire. If intermediate connection or insertion fixing are imperfect, it will cause electric shock, fire, etc.

When connecting the power supply cable and transmission cable, route the cables so that the rear case of this unit is securely fixed. If the rear case is imperfectly fixed, it may cause fire or overheating of the terminals.

Perform earth (ground) work positively. Do not connect the earth (ground) wire to a telephone cable, water pipe, or conductor rod.

Always fasten the outside covering of the connection cord with the cord clamp. (If the insulator is chafed, electric leakage may occur.)

When performing cable wiring work, be sure that it does not touch the user. Doing so will cause injury or electric shock.

If any cable is damaged, do not repair or modify it yourself. Improper work will cause electric shock or fire.

CAUTION

Do not set the DIP switch of this unit except as specified in this manual or the installation manual supplied with the air conditioner.

Setting the switches other than specified will cause an accident or trouble.

Use an insulated screwdriver to set the DIP switches.

Before opening the case of this unit, completely discharge static electricity charged on you body. Not doing so will cause trouble.

Do not touch the circuit board and circuit board parts directly with your hands. Otherwise, injury or electric shock could result.

Tightening the mounting screws too tight will damage the case of this unit.

Be careful so that the front cover does not fall after the front cover screws are removed. Otherwise, injury could result.

When performing wiring work, be careful not to damage the cable or injure yourself. Also, connect the connectors securely. Loose connectors will cause trouble, heating, fire, or electric shock.

Install the power supply cable and remote controller cables of the indoor or outdoor unit 40 in. (1 m) away from television and radio to avoid distorted images and noise.

Perform wiring so that water does not enter this unit along the external wiring. Always install a trap to the wiring or take other countermeasures. Otherwise it will cause trouble or electric shock or fire.

Confirm the name of each unit and name of each terminal block of the unit and connect the wiring in accordance with the directions given in the manual so that there is no incorrect wiring. Incorrect wiring will damage the electric parts and cause smoke and fire.

When installing the connection cable near a source of electromagnetic waves, use shielded cable. Otherwise, a breakdown or malfunction could result.

5.1. Installation

Open the operation panel on the front of the remote controller, remove the 2 screws indicated in the following figure, and then remove the front case of the remote controller.

When open the remote controller, remove the connector from the front case. The cables may break if the connector is not removed and the front case hangs down. When installing the front case, connect the connector to the front case. When removing and connecting the connector, be careful not to break the cables.

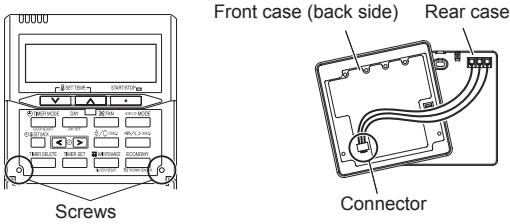

- (1) Pass the remote controller cable through the hole in the rear case and connect the remote controller cable to the remote controller terminal block specified in Fig. 1.
- (2) Clamp the remote controller cable sheath with the binder as shown in Fig. 1.
- (3) Cut off the excess binder.
- (4) Install the rear case to the wall, box, etc., with 2 screws (Fig. 2).

Fig. 1

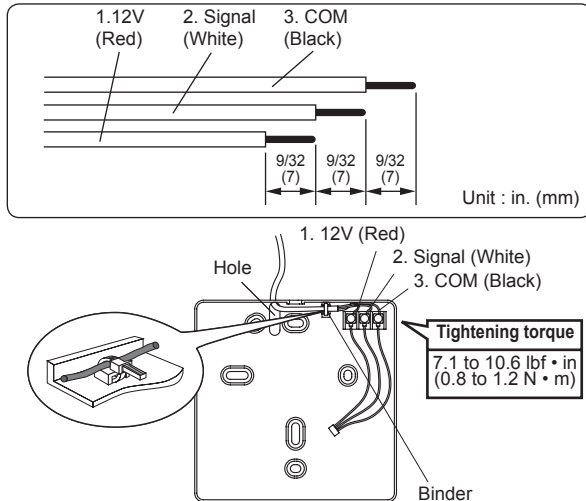

CAUTION
Be careful to avoid breaking the cable by over-tightening the binder.

CAUTION
When connecting the remote controller cables, do not over-tighten the screws.

Fig. 2 [Example]

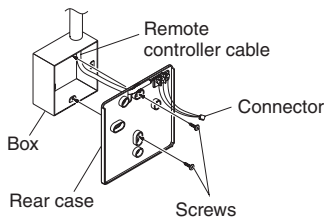

5.2. Setting the DIP switch

Set the remote controller DIP switches (Fig. 3).
Set DIP switch 1 - NO.6 to ON.
For the other switch, set it according to the situation.

Fig. 3
[Example]

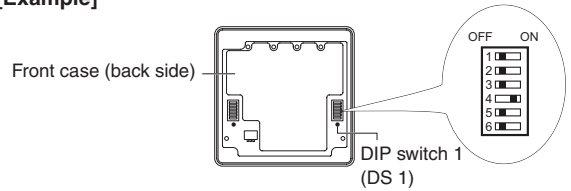

	NO.	Switch state		Detail
		OFF	ON	
DIP switch 1 (DS 1)	1	★ Fixed at OFF		Cannot be used
	2	★ Master	Slave	Refer to 6 INSTALLATION METHODS.
	3	★ Fixed at OFF		Cannot be used
	4		★ Fixed at ON	Cannot be used
	5	★ Fixed at OFF		Cannot be used
	6	★ Disable	Enable	Memory backup setting *1

(★ Factory setting)

*1. Memory backup setting : Set to ON to use batteries for the memory backup. If batteries are not used, all of the settings stored in memory will be deleted if there is a power failure.

5.3. Connection of Remote Controller Cable

CAUTION

- When connecting the remote controller cable to the indoor unit, do not connect it to the outdoor unit or the power terminal block. It may cause a failure.

There are 2 methods to connect the remote controller cable to the indoor unit. One is the connection using contained connecting cable, and the other is the connection the remote controller cable is connected to the exclusive terminal block of the indoor unit.

Exclusive terminal block for remote controller connection method is different depending on each model. Modify the remote controller cable as per below description and connect it. (For the details, refer to the installation manual of the indoor unit to be used.)

5.3.1. When connecting to the connector

Connect the remote controller cable to the connecting cable, and insert it to the connector.

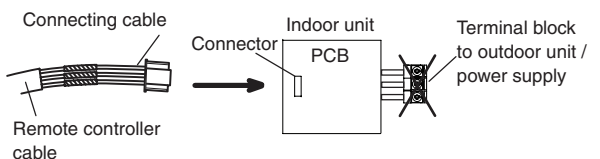

Modify the cable as per below methods.

- (1) Use a tool to cut off the terminal on the end of the remote controller cable, and then remove the insulation from the cut end of the cable as shown in Fig. 1.
- (2) Connect the remote controller cable and connecting cable as shown in Fig. 2.
- (3) Be sure to insulate the connection between the cables.

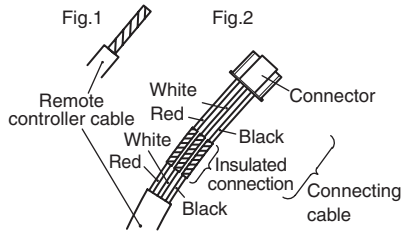

5.3.2. When connecting to exclusive terminal block

- (1) When connecting to the exclusive terminal block of TYPE A or TYPE B (Fixing screw of M3)
Cut the Y-type terminal at the end of remote controller cable and connect it.

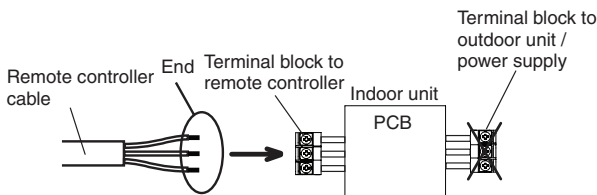
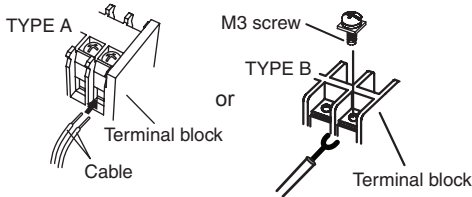

- ※ Y-type terminal may be damaged if it is inserted to the exclusive terminal block strongly.
- ※ It may be failed if it is connected to the outdoor unit or the terminal block for power supply.

- (2) When connecting to the exclusive terminal block of TYPE C (Fixing screw M4)

Connect the end of remote controller cable directly to the exclusive terminal block.

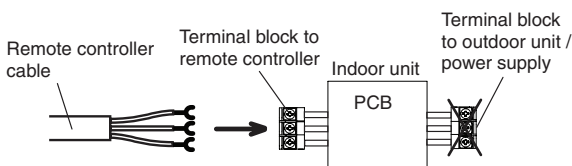
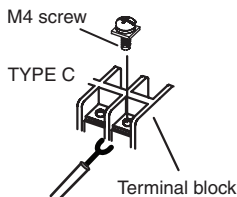

- ※ It may be failed if it is connected to the outdoor unit or the terminal block for power supply.

6. INSTALLATION METHODS

6.1. Group control

- (1) Wiring method (indoor unit to remote controller)

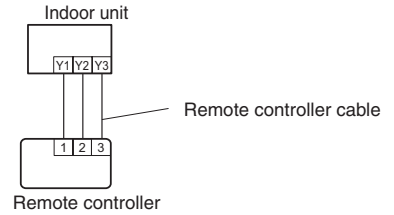

- A number of indoor units can be operated at the same time using a single remote controller.

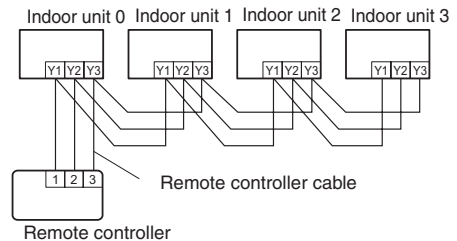

- (2) Remote controller address setting

Set each remote controller address using the switch of each indoor unit in order from 0.

(Refer to the installation manual for the indoor unit.)

Up to 16 indoor units can be connected.

6.2. Dual remote control

- 2 remote controllers can be used to operate the indoor units.
- The timer cannot be used on the slave units.
- ADDRESS SETTING and FUNCTION SETTING cannot be used on the slave units.
- The remote controller (UTB- * LA) and remote controller (UTB- * U *, UTB- * P *, UTB- * R *) cannot be connected at the same time.

- (1) Wiring method

(indoor unit to remote controller)

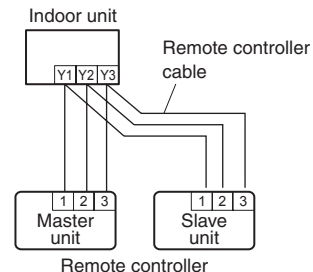

- (2) Remote controller DIP Switch 1- No. 2 setting

Set the remote controller DIP switch 1- No. 2 according to the following table.

Number of remote controllers	Master unit DIP switch 1 - No. 2	Slave unit DIP switch 1 - No. 2
1 (Single)	OFF	—
2 (Dual)	OFF	ON

- Group control and dual remote control can be used together.
- When connecting 2 remote controllers, the remote controller can also be connected together with another type of remote controller.

7. TURNING ON THE POWER

CAUTION

- Recheck the wiring. Incorrect wiring will cause trouble.

- (1) Check the remote controller wiring and DIP switch settings.
- (2) Install the front case.

* When installing the front case, connect the connector to the front case (in 5 INSTALLING THE REMOTE CONTROLLER).

- (3) Check the indoor and outdoor unit wiring and circuit board switch settings, and then turn on the power of the indoor and outdoor units.

After “9C” has flashed on the set temperature display for several seconds, the clock display will appear in the center of the remote controller display.



- * For the wiring and circuit board switch settings method, refer to the installation manual for the indoor unit and outdoor unit.

8. SETTING THE ROOM TEMPERATURE DETECTION LOCATION

CAUTION

- As the temperature sensor of remote controller detects the temperature near the wall, when there is a certain difference between the room temperature and the wall temperature, the sensor will not detect the room temperature correctly sometimes. Especially when the outer side of the wall on which the sensor is positioned is exposed to the open air, it is recommended to use the temperature sensor of the indoor unit to detect the room temperature when the indoor and outdoor temperature difference is significant.

The detection location of the room temperature can be selected from the following 2 methods. Choose the detection location that is best for the installation location.

The temperature sensor of the indoor unit or the remote controller can be used to detect the room temperature.

Press the “ECONOMY / THERMO SENSOR” button for 2 seconds or more to select the temperature sensor of the indoor unit or the remote controller.



NOTES



The remote controller sensor cannot be used if the indoor unit has no temperature setting function. When this function cannot be used, the lock display  will flash when the “ECONOMY / THERMO SENSOR” button is pressed.

9. ADDRESS SETTING

Address setting method of indoor unit can be selected from 3 options (outdoor unit, indoor unit and remote controller). Refer to the installation manual of outdoor unit or indoor unit when set up from the outdoor unit or the indoor unit.

- “Indoor unit address” and “Refrigerant circuit address” can be set using the remote controller.
- This function can be set in all indoor units when the remote controller is connected.
- “Remote controller address” cannot be set in this function. Ensure to set with the Rotary switch of PCB of the indoor unit.
- When setting the address of indoor unit, refer to installation manual of indoor unit.
- When setting the address of outdoor unit automatically, refer to installation manual of outdoor unit.
- When setting the address with a remote controller, refer to installation manual of indoor unit for setting details of indoor unit.

Switching selection of address setting mode

- (1) Press the “ SET TEMP. ” button, “ FAN” button for more than 5 seconds simultaneously. Then shift to Address setting mode.

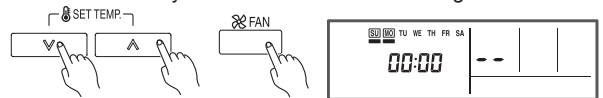

Address setting mode initial display



Indoor unit address setting

- (2) Press the “ SET BACK” button and select the Remote controller address (Select the relevant indoor unit).

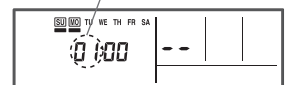
Remote controller address





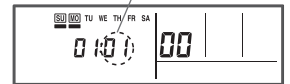
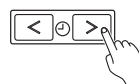

Ex. When Remote controller address “01” is selected.

- (3) The Address code “01” blinks when pressing the “<  ” button or “ >” button.

Address code



- (4) Set the Indoor unit address data by pressing the “ SET TEMP. ” button or “ SET TEMP. ” button. (Range of setting is 00-63.)

Indoor unit address data

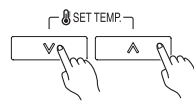

Ex. When Indoor unit address data “12” is selected.

(5) Fix the Indoor unit address data by pressing the "TIMER SET" button. (Data is transferred to the indoor unit).

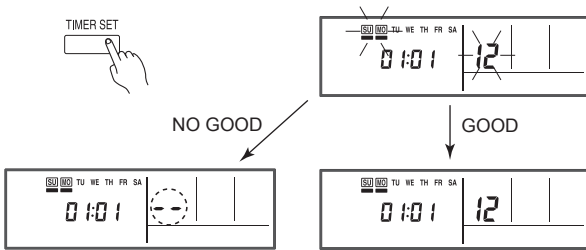

- When Indoor unit address data is not set in the indoor unit address. (— is displayed).
- Set the Indoor unit address data again as per procedure (3)-(5) above.

When Indoor unit address data is set in the indoor unit properly. (Blinking changes to steady illumination)

(9) Fix the Refrigerant circuit address data by pressing the "TIMER SET" button. (Data is transferred to the indoor unit)

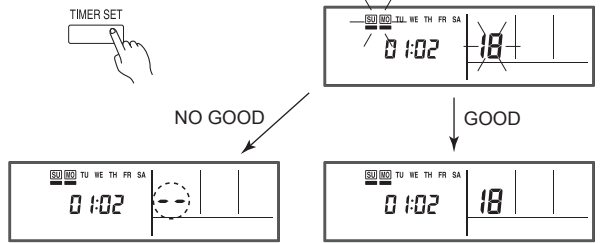

- When Refrigerant circuit address data is not set in the indoor unit. (— is displayed)
- Set the Refrigerant circuit address data again as per procedure (8)-(9) above.

When Refrigerant circuit address data is set in the indoor unit properly. (Blinking changes to steady illumination)

Refrigerant circuit address setting

(6) Press the "SET BACK" button and select the Remote controller address (Select the relevant indoor unit).

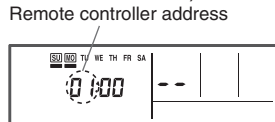

Remote controller address
Ex. When Remote controller address "01" is selected.

(7) The Address code "02" blinks when pressing the "< ⊖" button or "⊕ >" button.

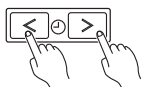

< : Down button
> : Up button

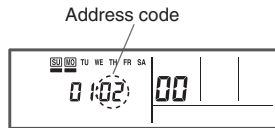

Address code

Completion of address setting mode

(10) Address setting mode is released and returns to normal display if the "SET TEMP. ∇" button, "SET TEMP. ▲" button and "FAN" button are pressed simultaneously.

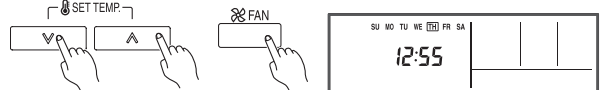

Normal mode display

* Address setting mode is released automatically if no key is pressed for 60 seconds even the above buttons are not pressed. (Switch to Address setting mode as per procedure (1) above.)

(11) After completing the ADDRESS SETTING, be sure to turn off the power and turn it on again.

(8) Set the Refrigerant circuit address data by pressing the "SET TEMP. ∇" button or "SET TEMP. ▲" button. (Range of setting is 00-99.)

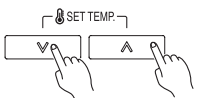

Refrigerant circuit address data

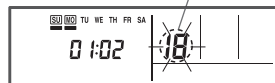

Ex. When Refrigerant circuit address data "18" is selected.

10. FUNCTION SETTING

This procedure changes the function settings used to control the indoor unit according to the installation conditions. Incorrect settings can cause the indoor unit to malfunction. Perform the "FUNCTION SETTING" according to the installation conditions using the remote controller.

- Refer to the indoor unit installation manual for details on the function numbers and setting numbers.
- Prepare for setting of indoor unit referring to installation manual of indoor unit before start of functional setting.

(1) Press the "SET TEMP. ∇" button, "SET TEMP. ▲" button and "FAN" button simultaneously for more than 5 seconds to enter the function setting mode.



(2) Press the "SET BACK" button to select the indoor unit number.



Unit number of INDOOR UNIT

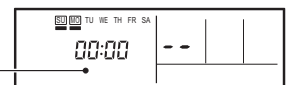

- (3) Press the “< ⊕” button or “⊖ >” button to select the function number.



- (4) Press the “⊕ SET TEMP. ∇” button or “⊕ SET TEMP. ▲” button to select the setting number. The display flashes during setting number selection.

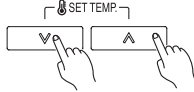

- (5) Press the “TIMER SET” button to confirm the setting. Press the “TIMER SET” button for a few seconds until the setting number stops flashing. If the setting number display changes or if “-” is displayed when the flashing stops, the setting number has not been set correctly. (An invalid setting number may have been selected for the indoor unit.)

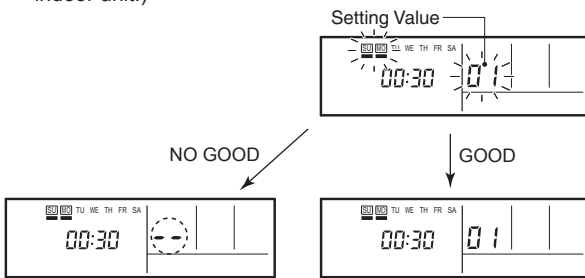

- When Setting Number data is not set in the indoor unit. (-- is displayed)
- Set the Setting Number data again as per procedure (4)-(5) above.

When Setting Number data is set in the indoor unit properly (Blinking changes to steady illumination)

- (6) Repeat steps 2 to 5 to perform additional settings. Press the “⊕ SET TEMP. ∇” button, “⊕ SET TEMP. ▲” button and “FAN” button simultaneously again for more than 5 seconds to cancel the function setting mode. In addition, the function setting mode will be automatically canceled after 1 minute if no operation is performed.

- (7) After completing the FUNCTION SETTING, be sure to turn off the power and turn it on again.

11. ADMINISTRATIVE INDOOR UNIT SETTING

- If “Priority on Administrative Indoor Unit” is selected in the setting of priority mode by PUSH SWITCH of outdoor unit (refer to installation manual of outdoor unit), an indoor unit selected from the same refrigerant system can be set to “Administrative Indoor Unit”. “Administrative Indoor Unit” shall be set by the wired remote controller.

<What is Administrative Indoor Unit>

An indoor unit which decides the priority mode (cooling or heating) in a same refrigerant system.

- “Administrative Indoor Unit” can be set to a unit in a same refrigerant system.

<About setting and releasing of Administrative Indoor Unit>

- Setting and releasing of “Administrative Indoor Unit”.

- (1) After the indoor unit stops operation, press the “⊕ MODE” button of wired remote controller for 5 seconds continuously.
- The operating mode of the wired remote controller display lights on after 5 seconds as follows.

- (1)-a) The indication not set as “Administrative Indoor Unit”.

- (1)-b) The indication set as “Administrative Indoor Unit”.

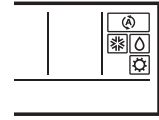
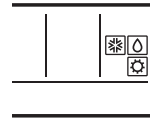

Note:

- “⊕ MODE” button is locked by below reasons while the marking  lights on. In such case, “Administrative Indoor Unit” cannot be set or released.

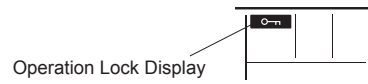

- “Priority on Administrative Indoor Unit” is not selected in the setting of priority mode of outdoor unit.
 - ⇒ Set “Administrative Indoor Unit” in the wired remote controller after selecting “Priority on Administrative Indoor Unit” in setting of priority mode of outdoor unit.
- Another indoor unit was set to “Administrative Indoor Unit” already.
 - ⇒ Release the setting “Administrative Indoor Unit” of another indoor unit.

- Set or release “Administrative Indoor Unit”.

- (2) Press the “⊕ MODE” button.

- Display (1)-b) when setting, and display (1)-a) when releasing.

⇒ The display blinks when the “⊕ MODE” button is pressed, and the display of (1)-a) and (1)-b) alters whenever the “⊕ MODE” button is pressed.

⇒ The contents set in the wired remote controller are transferred to the indoor unit immediately after the display is selected. It may take 10 seconds depending on communication conditions. While this period, the button operation will be suspended.

⇒ It returns to the normal display after 20 seconds automatically if the operation button is not pressed.

⇒ When setting or releasing is completed, the indication on wired remote controller changes to the normal indication from blinking.

- (3) Complete the setting or releasing of “Administrative Indoor Unit”.

- Press the “⊕ MODE” button of the wired remote controller again for 5 seconds continuously.

⇒ The indication returns to normal display if the “⊕ MODE” button is pressed for 5 seconds continuously.

(It returns to normal indication after 20 seconds even if the “⊕ MODE” button is not pressed.)

12. TEST RUN

- Test run method of the indoor unit is explained.
- Refer to the indoor unit installation manual for the list of items to check.

(1) If the operation lamp is on, press the “START/STOP” button to turn it off.

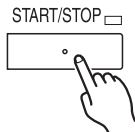

(2) Press the “MODE” button and “FAN” button at the same time for more than 2 seconds to start the test run.

The operation lamp will light up and “01” will be displayed on the set temperature display.

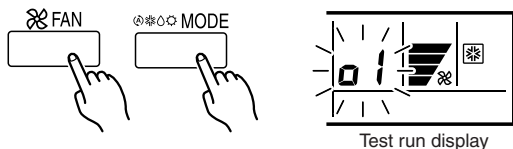

(3) To stop the test run, press the “START/STOP” button.

* The “SET TEMP. ↓” button or “SET TEMP. ↑” button do not function. However, the other buttons can be used to change the settings.

* Test run is used for constrained operation of the outdoor unit.

Note:

- When “02” is indicated on the temperature display, it means under maintenance. Indoor unit cannot be operated.

13. ERROR CODE DISPLAY

If an error occurs, the following display will be shown.

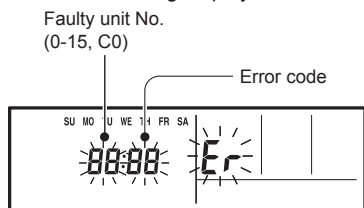

Ex. Error code display

Do not use the operation below if an error has occurred.

- When 0-15 is indicated on the Faulty unit No., error has occurred at the indoor unit. Refer to the indoor unit installation manual.

Faulty unit No.	Error code	Error code
00	12	Indoor unit ↔ remote controller communication error
00	15	Incompatible indoor unit is connected

14. GENERAL SPECIFICATIONS

Temperature °C(°F)	Operating	0–46 (32–114)
	Packaged	-10–60 (14–140)
Humidity (%)	Packaged	0-90 (RH); No condensation