

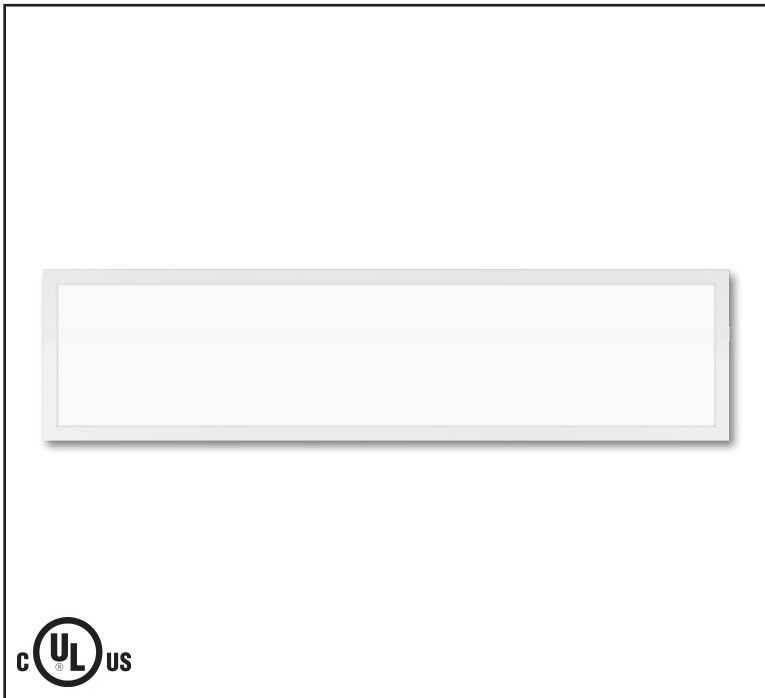

MODEL #: ORBLP14SEL2-4L

UPC #: 765364028915

# 1'x4' Selectable Panel



## Specifications

### Electrical Specifications

- Input Wattage: Selectable 15 - 33W
- Efficacy: 125 LpW
- AC Input: 120/208/240/277 V
- Driver: Constant current, Class 2, 120-277VAC 50/60Hz
- Dimming: 0-10V

### Lighting Specifications

- Lumens: Selectable 1,875 - 4,125
- Color Temperature: Selectable 3500K, 4000K, 5000K CCT
- Color Rendering Index: 80

### Housing Specifications

- Stamped aluminum housing
- Color: White
- Lifespan: 50,000 hours

### Listings

- UL/cUL standards for damp location

### Warranty

- 5-Year limited warranty

Model	Watts	Lumens	Volts	Color Temp.
ORBLP14SEL2-4L	15	1875	120-277	Selectable 3500K 4000K 5000K
	25	3125		
	33	4125		

## Photometrics

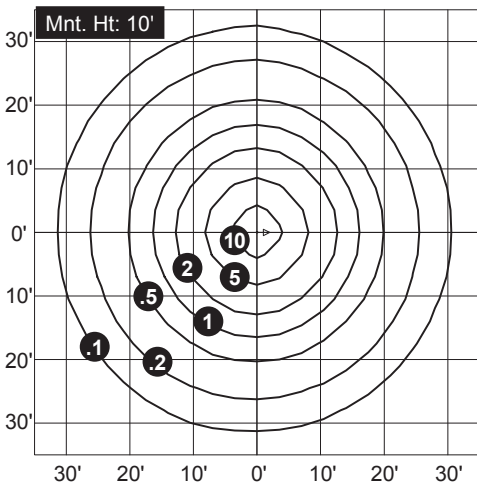

Light Loss Factor	1.00
Total Lumens	4,125
Mounting Height	10'
Max. Calculated Value	13.55Fc



# origin

BY ATLAS  
LIGHTING

PROJECT INFORMATION

MODEL #: ORBLP14SEL2-4L

UPC #: 765364028915

## 1'x4' Selectable Panel

### Dimensions

#### Product Dimensions

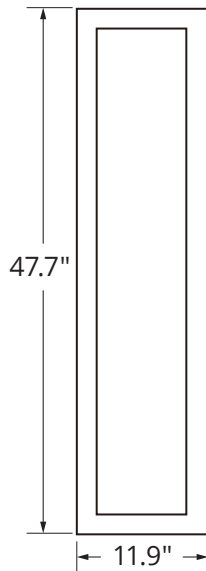

#### Carton Dimensions

Weight: 4.96 lbs.

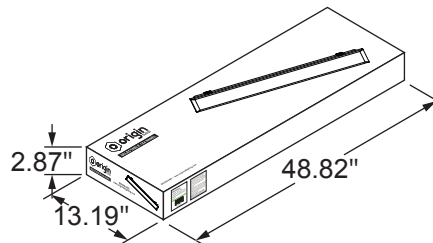

#### Pallet Dimensions

Qty: 80

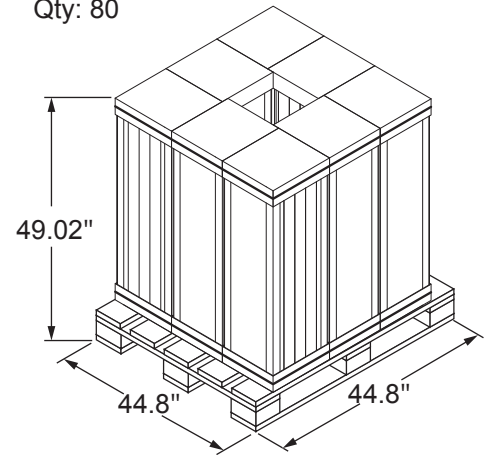

### Installation

#### LUMEN AND CORRELATED COLOR TEMPERATURE SELECTABLE INSTRUCTIONS

Different lumen and correlated color temperature levels can be achieved by setting the switch on the driver cover to different positions.

#### Lumen Selection

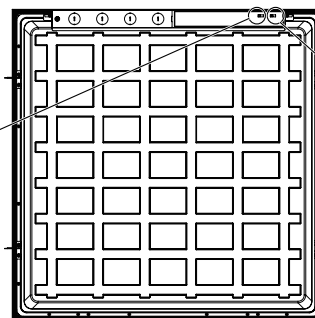
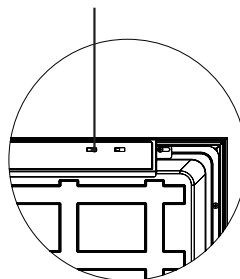

#### CCT Selection

