

SPECIFICATION AND INSTALLATION GUIDE

FCR2 Field Cut Riser System

For use with grease interceptor models GB-50, GB-75, GB-250, GB-500, GB-1000, GGI-500, GGI-750, GGI-1000, GGI-1500 and GGI-2000; solids interceptor models SI-50, SI-75, SI-250 and SI-500; sampling port models SV24 and SV24-O; and wastewater flow distributor FS-DUO

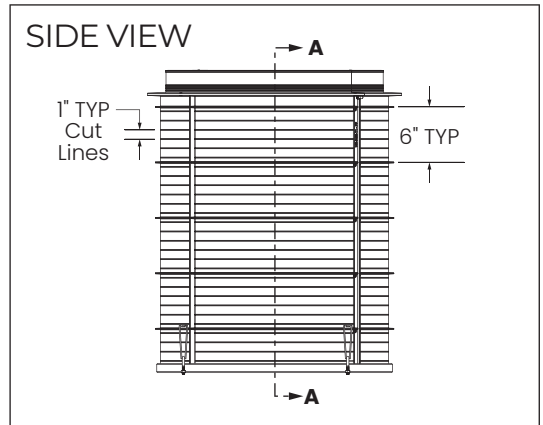
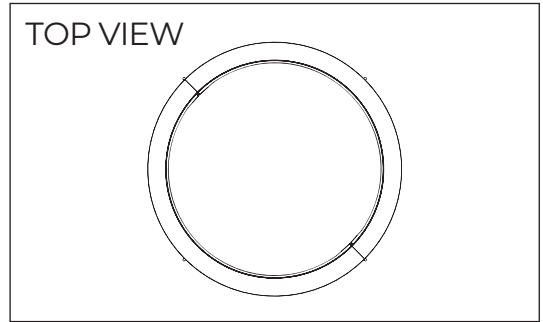
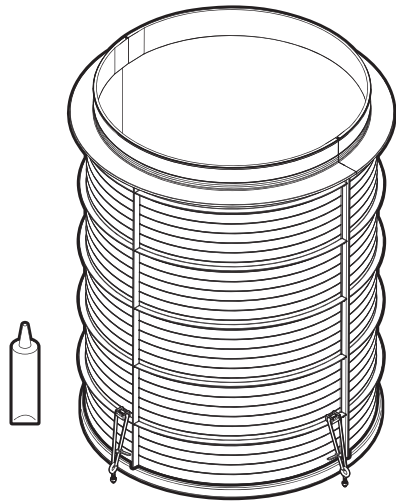

Contents

Specifications	1
Special Precautions	2-3
Getting to Know the FCR2	4
Installation	5-9
FCR2 Compatible Models	10

Notes

- Unit weight: 32 lbs.
- Riser not designed to hold water

Engineer Specification Guide:

Field-cut adjustable riser system to consist of injection molded polypropylene body, 100% Silicone Sealant for assembly of riser components, butyl mastic sealant for tank-riser or riser-riser joints, stainless steel fastening hardware and heavy duty nylon cable ties and mounts. Riser shall allow field adjustability of cover to grade.

Installation Note

Minimum install height: 4". Maximum install height: 34". Riser system may be stacked no more than three units high to a maximum of 94" extension. Access to internal components will not be compromised.

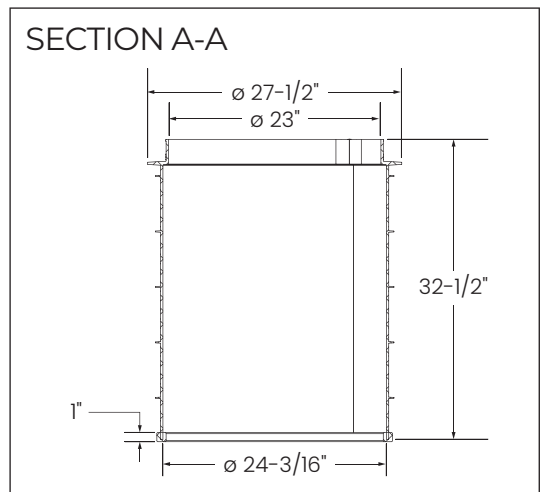

Riser Height Needed	Risers Required (per accessway)
0" - 4"	None (use adapter)
>4" - 34"	FCR2
>34" - 64"	FCR2 (x2)
>64" - 94"	FCR2 (x3)



MODEL NUMBER:
FCR2

DESCRIPTION: 34" Field Cut Riser System

PART #: 8010-006-01

DWG BY: B. Karrer

DATE: 6/24/2020

REV:

ECO:



SPECIAL PRECAUTIONS

For Schier riser Installations - Failure to follow this guidance voids your warranty

WARNING! DO NOT AIR TEST UNIT OR RISER SYSTEM!
Doing so may result in property damage, personal injury or death.

CAUTION! Do not install this unit in any manner except as described in these instructions.

Installation Instructions

Installation instructions and additional components are included with the base unit. Read all instructions prior to installation. This riser is intended to be installed by a licensed plumber in conformance with all local codes.

Installations with Risers

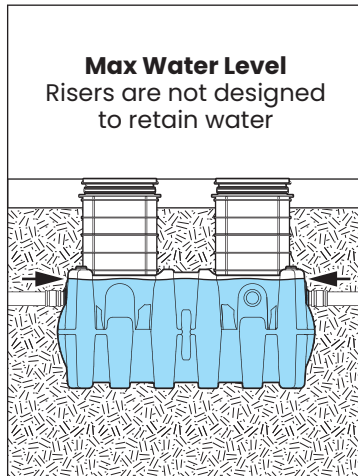
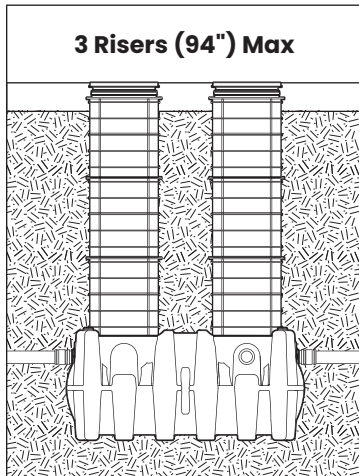

High Water Table Installations

Interceptors and risers are not designed to withstand water table height in excess of the top of the unit when buried (see figure). If it is possible for this to occur, install the interceptor and risers in a water-tight concrete vault or backfill with concrete or flowable fill (wet concrete and flowable backfill should be poured in stages to avoid crushing the interceptor). At risk areas include but are not limited to tidal surge areas, floodplains and areas that receive storm water. Models that are direct buried in high water table scenarios must be installed with an anchor kit. See base unit installation instructions for selecting appropriate anchor kit.

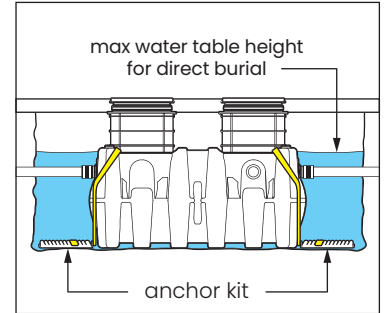

Hydrostatic/Pressure Slabs

When installed under a hydrostatic slab (slab designed to withstand upward lift, usually caused by hydrostatic pressure) interceptor must be enclosed in a watertight concrete vault.

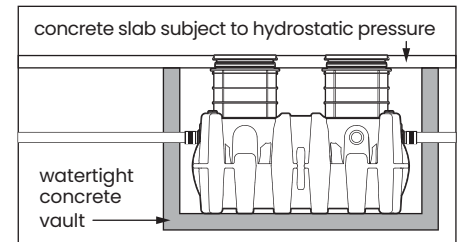

CAUTION!

Do not add any form of lubricant to cover adapter/gasket assembly or risers during installation.

CAUTION!

Make Sure Parts Are Clean When Applying Silicone or Mastic Sealant

Below Grade Installation Slab Requirements

A concrete slab to finished grade with rebar is required when installing interceptor below grade.

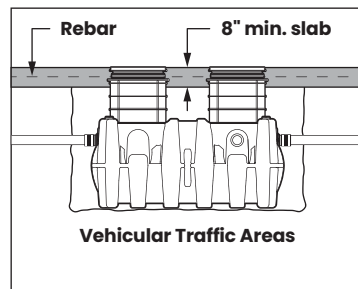
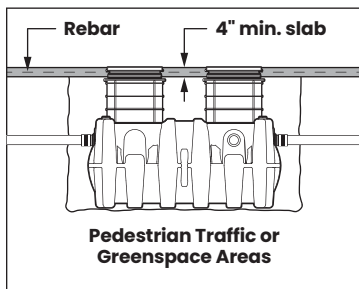

DO NOT COMPACT BACKFILL

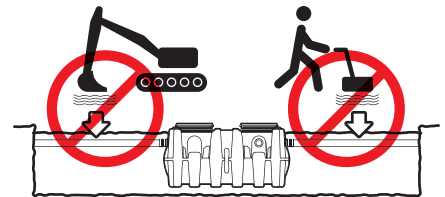



SPECIAL PRECAUTIONS

For Schier riser Installations - Failure to follow this guidance voids your warranty

High Temperature Kitchen Water



If water is entering the interceptor at excessive temperature (over 150° F), a drain water tempering valve (DTV) and approved backflow prevention assembly must be installed. Most state and local plumbing codes prohibit water above 150° F being discharged into the sanitary sewer. Water above 150° F will weaken or deform PVC Schedule 40 pipe, poly drainage fixtures like interceptors and erode the coating of cast iron (leading to eventual failure).

ODOR ALERT!

Interceptor is not a sewer gas trap. All upstream fixtures must be trapped

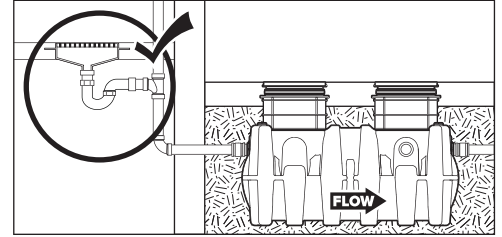

ODOR ALERT!

Do not install air gap on outlet side of interceptor.

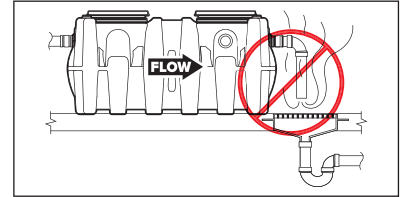

Fully Support Base of Unit

Install unit on solid, level surface in contact with the entire footprint of unit base

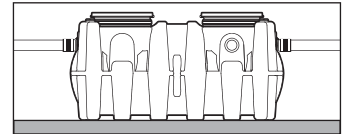

Support Inlet and Outlet Piping

For above grade installations ensure heavy inlet and outlet piping (such as cast iron or long runs) is properly supported or suspended during the entire installation process to prevent connection failure or damage to bulkhead fittings.

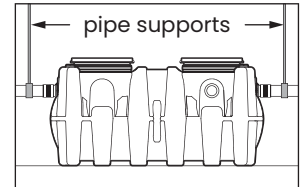

DO NOT USE CAST IRON COVERS IN ABOVE GRADE OR INDOOR INSTALLATIONS

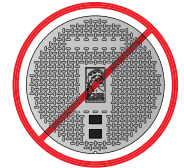

GETTING TO KNOW THE FCR2

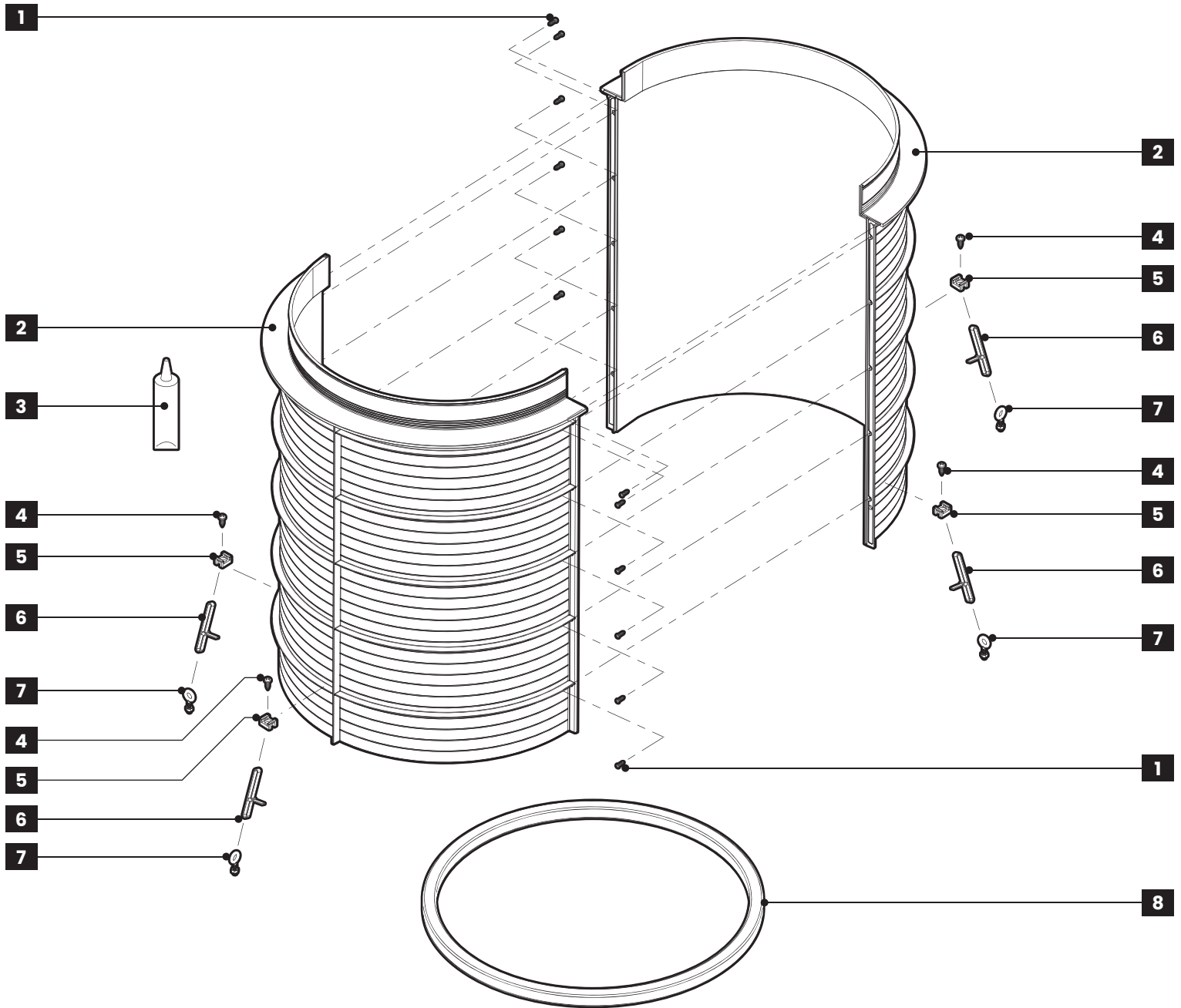

- | | |
|---|---|
| 1. #8 x 5/8" riser body assembly screw (x12) | 5. Cable tie mounts(x4) |
| 2. Riser body half (x2) | 6. Heavy duty 18" - 120 lb. cable tie (x4) |
| 3. 100% silicone sealant | 7. Stainless steel eyebolt and nut (x4) |
| 4. #10 x 3/4" phillips head stainless steel screws (x4) | 8. 1" square x 80" block butyl mastic sealant |

INSTALLATION

Tools You Will Need



Tape Measure



#2 Phillips Head Screwdriver



Reciprocating Saw, Circular Saw or Jigsaw



Drill with 1/2" Chuck



Level

1/4" Drill Bit

INCLUDED WITH BASE UNIT

7/16" Nut Driver Bit

1 Determine riser height needed and trim risers.

1a Measure dimension X to determine riser height needed.

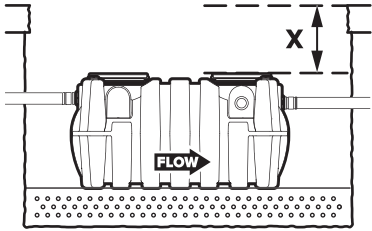

Riser Height Needed (X)	Risers Required (per accessway)
0" - 4"	None (use adapter)
>4" - 34"	FCR2 (x1)
>34" - 64"	FCR2 (x2)
>64" - 94"	FCR2 (x3)



1b Determine trim length (round up all fractions to next inch). **Only one FCR2 riser per cover will need to be cut.**

Riser Height Needed	Trim Length =
0" - 4"	-
>4" - 34"	31" - Riser Height (X)
>34" - 64"	62" - Riser Height (X)
>64" - 94"	93" - Riser Height (X)

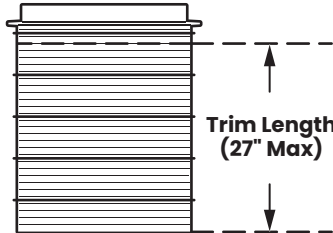

1c Measuring from bottom of riser, mark trim length and cut riser halves.

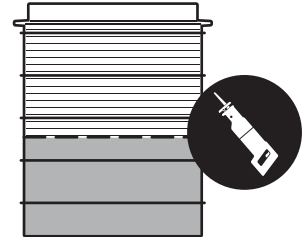

NOTE: If trim length is 0 or less, no cutting is required. Trimming risers using these guidelines will result in risers that are 0-2" shorter than the exact riser height needed. Cover Adapter adjustability will allow for final adjustments to grade.

INSTALLATION

2 Assemble riser body halves.

- 2a** Apply silicone sealant (included) to the edge of **each** riser body half. Lay one bead into the entire length of the groove and another bead into the sealant trough next to the screw holes.

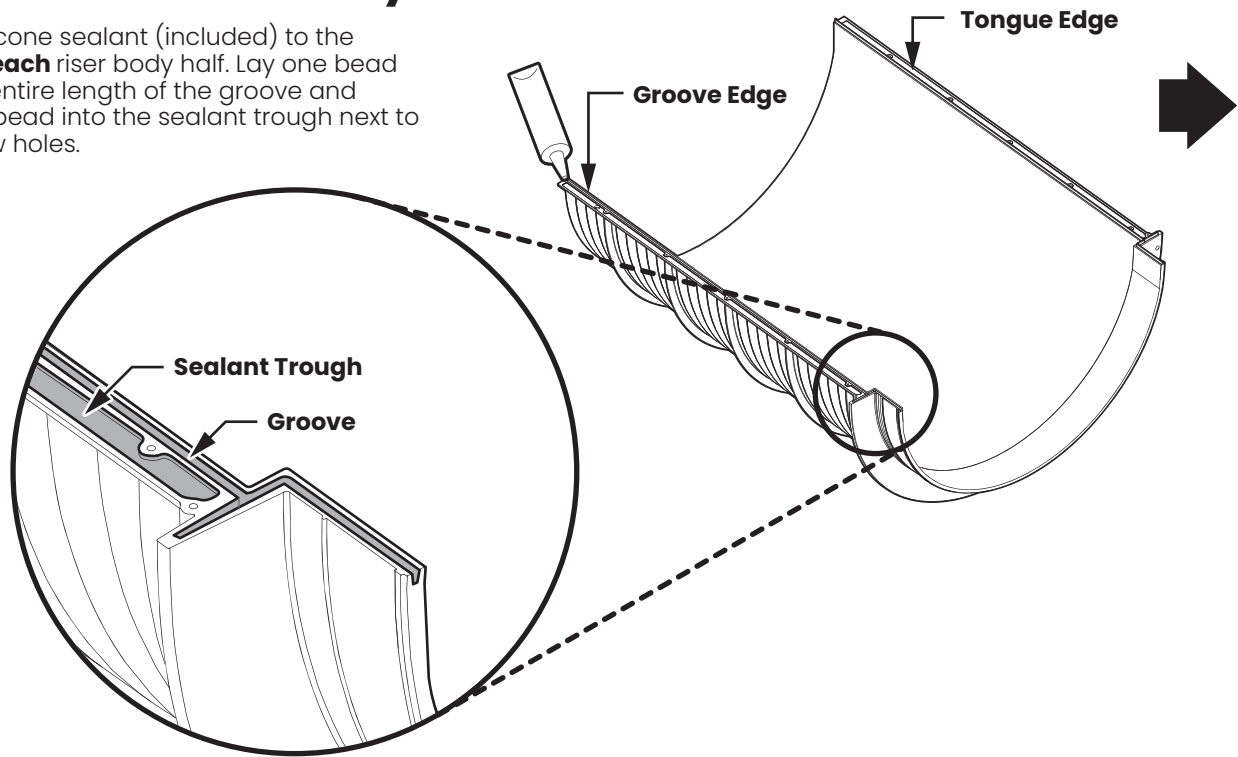

2b

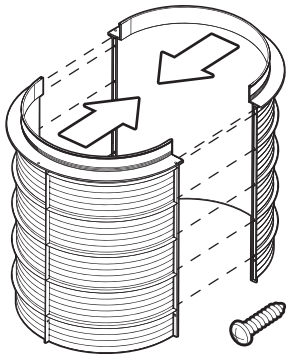

Immediately assemble riser halves after applying sealant and fasten using supplied screws.

INSTALLATION

3 Install risers onto base unit.

3a

Loosen the cover adapter lower band clamps using 7/16" nut driver bit.

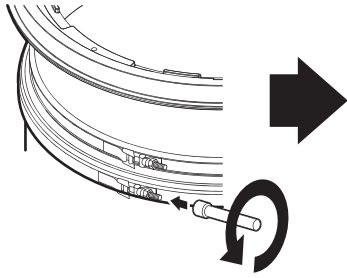

3b

Remove cover adapters.

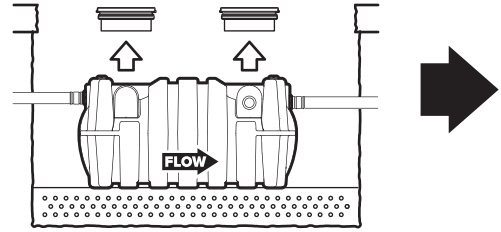

3c

x4

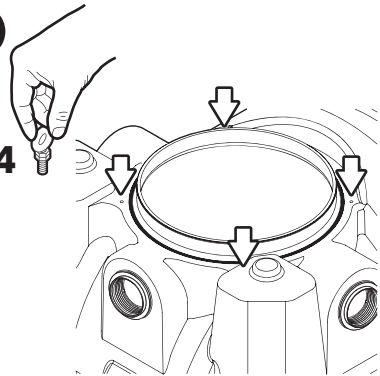

Remove insert plugs, then hand tighten eyebolts into threaded holes surrounding the accessway.

3d

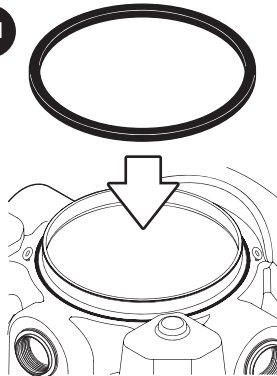

Lay butyl mastic sealant into the channel surrounding the accessway.

3e

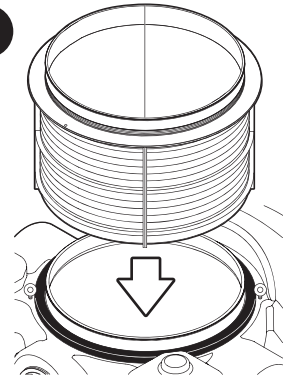

Place riser into position aligning vertical ribs with eyebolts.

4e

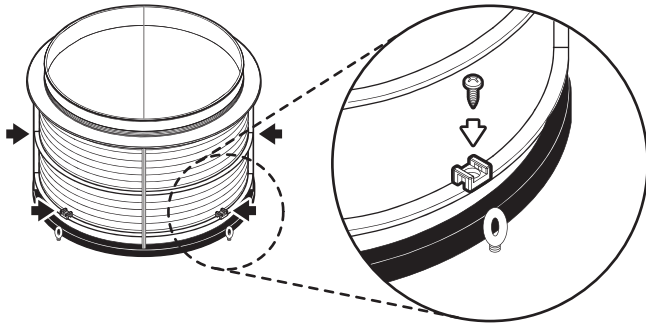

Install 4 cable tie mounts onto lowest horizontal structural rib using #10 x 3/4" screws. Make sure mounts are located directly above eyebolts and are positioned for horizontal cable tie placement.

3f

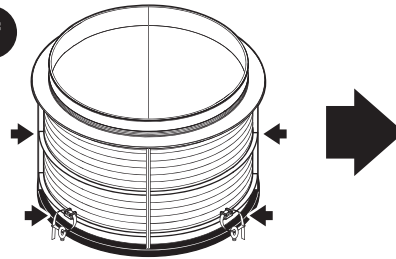

Loop cable ties through mounting holes and eyebolts, do not tighten.

3g

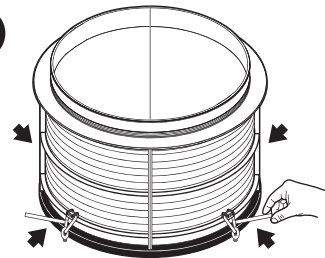

Tightening Pattern

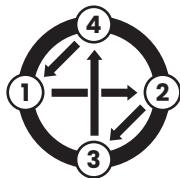

3h

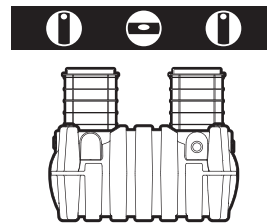

Make final adjustments to cable ties to ensure riser is level.

Tighten cable ties, a little bit at a time in a star pattern going around the riser to evenly force the riser into the mastic sealant. Riser should go 1/2" - 3/4" into the sealant.

INSTALLATION

4 Install risers onto risers (34"+).

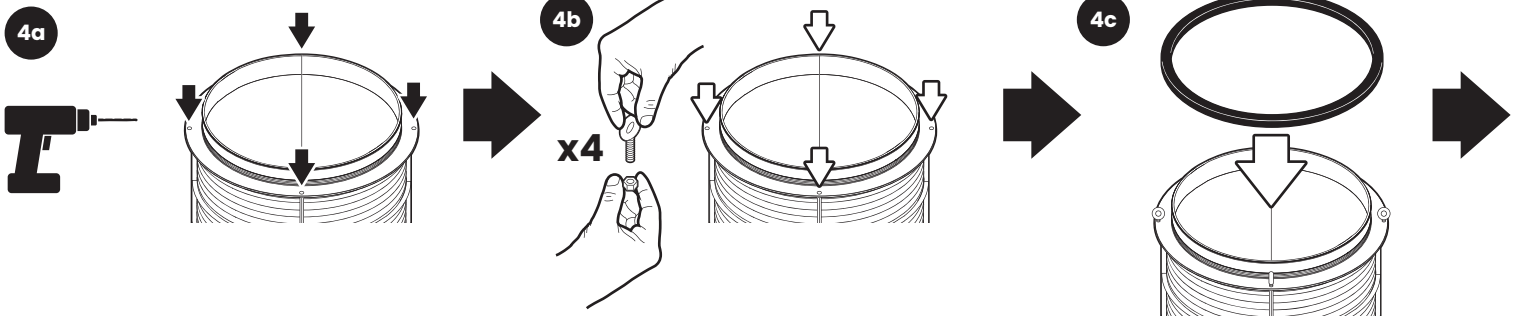

On bottom riser: drill (4) 1/4" mounting holes through flange.

On bottom riser: install eyebolts into holes in riser flange using supplied stainless steel nuts. Hand tighten only.

On bottom riser: lay butyl mastic sealant onto the flange surrounding the accessway.

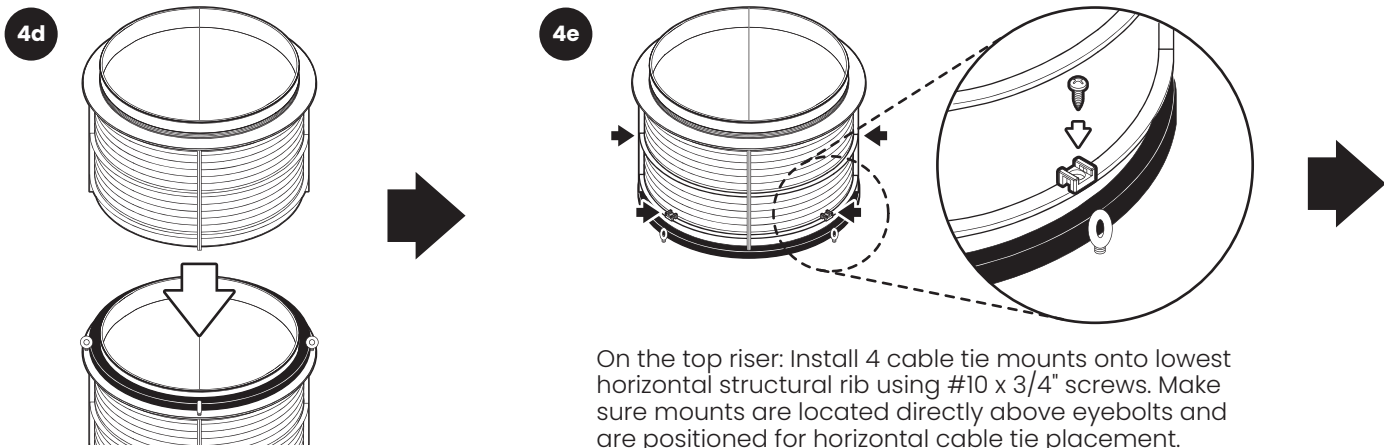

Place top riser onto bottom riser.

On the top riser: Install 4 cable tie mounts onto lowest horizontal structural rib using #10 x 3/4" screws. Make sure mounts are located directly above eyebolts and are positioned for horizontal cable tie placement.

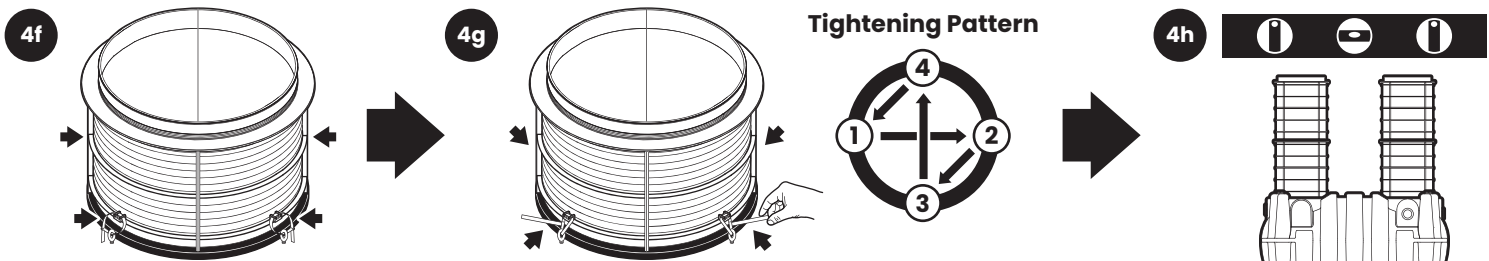

Loop cable ties through cable mounts and eyebolts, do not tighten.

Tighten cable ties, a little bit at a time in a star pattern going around the riser to evenly force the riser into the mastic sealant. riser should go 1/2" - 3/4" into the sealant.

Make final adjustments to cable ties to ensure riser system is level.

INSTALLATION

5 Install cover adapters.

5a Secure cover adapters onto risers.

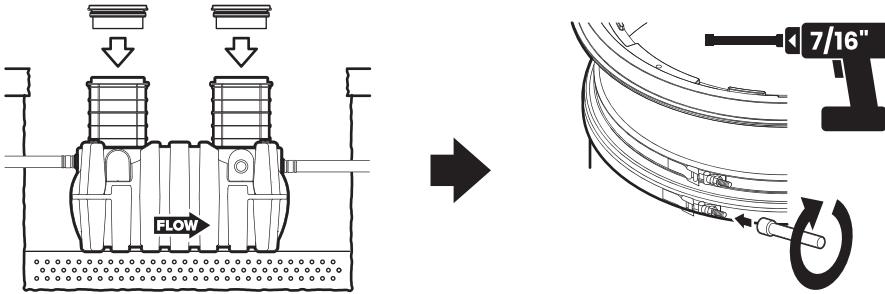

Place cover adapter/gasket assembly onto top level riser(s). Tighten lower band clamp to 5 -8 ft. lbs. of torque using 7/16" nut driver bit.

5b Make final cover adapter adjustments

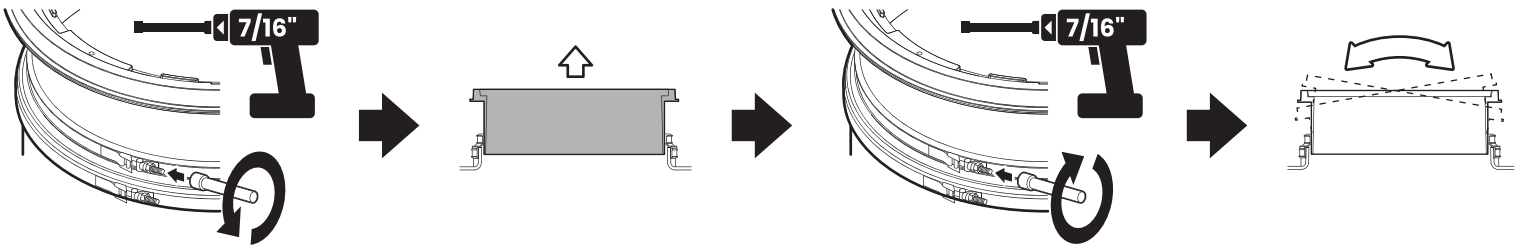

Loosen the cover adapter upper band clamp using 7/16" nut driver bit. Adjust cover adapter heights as needed. **Maintain a minimum 2-1/2" insertion depth.** Tighten upper band clamp to 5 -8 ft. lbs. of torque using 7/16" nut driver bit. If required, cover adapters may now be tilted up to 10° in any direction using gasket flexibility.

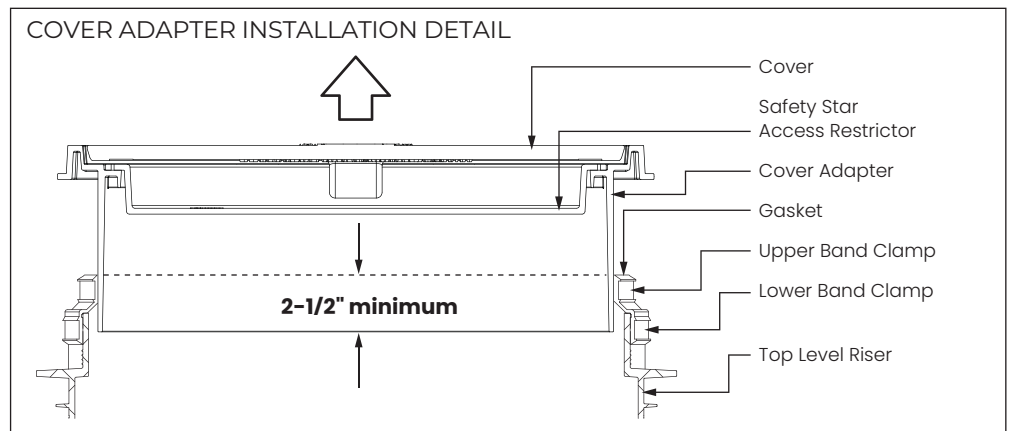

FCR2 COMPATIBLE MODELS

Great Basin™ Grease Interceptors



GB-50

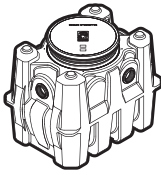

GB-75

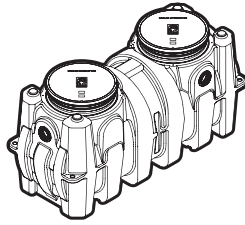

GB-250

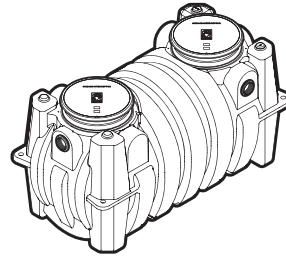

GB-500

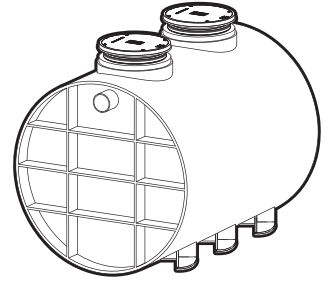

GB-1000

Big Foot™ Gravity Grease Interceptors

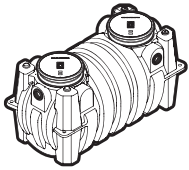

GGI-500

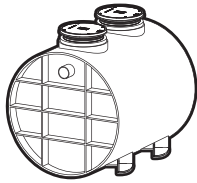

GGI-750

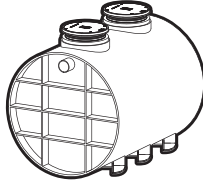

GGI-1000

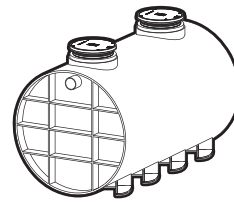

GGI-1500

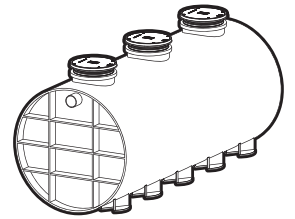

GGI-2000

Billy Goat™ Kitchen Solids Interceptors



SI-50

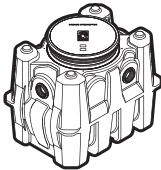

SI-75

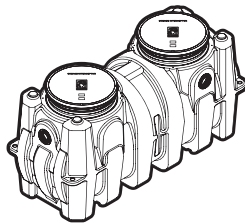

SI-250

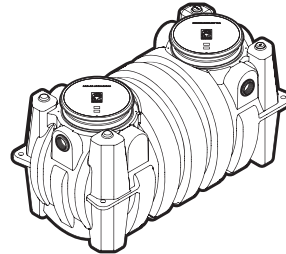

SI-500

Sewer Viewer™ Wastewater Sampling Ports

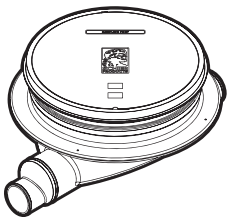

SV24

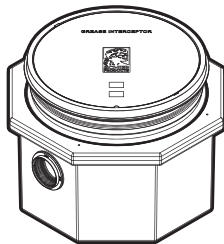

SV24-O

Flow Splitter™ Wastewater Flow Distributors

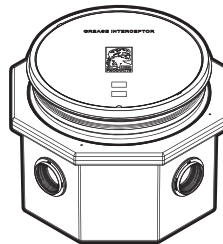

FS-DUO