



SIEMENS



Power Mod & Uni-PAK

Multi-Family Metering Solutions

www.usa.siemens.com/powermod

Table of Contents

Power Mod		
	Introduction Page	3
	Quick System Features	4
	Overview of Power Mod Families	5-11
	Power Mod Configuration Tips	12
	Applications	13-22
	WB - Standard Circuit Breaker Mains	23-25
	WEB - Circuit Breaker Pullbox Combinations	26-28
	WXB - Cross Bus Mains	29-30
	WBT - Feed Thru Mains	31-32
	WS - Standard Switch Mains	33-34
	WES - Switch Pullbox Combinations	35-36
	WTB - Standard Tapboxes	37-38
	WET - Tapbox Pullbox Combinations	39-40
	WT - Feed-Thru Tapboxes	41-42
	WMM - Residential Meter Stacks	43-46
	WML - Lever Bypass Meter Stacks	47-51
	WML- Fusible Switch Lever Bypass Meter Stacks	52-53
	WMLZ - Fusible Residential Lever Bypass Meter Stacks	54-55
	WMT - Test Block Bypass Meter Stacks	56-57
	WMK - K-Base Meter Stacks	58-59
	WC - House Power Module	60-62
	WCL - Lever Bypass House Power Module	63-64
	WCT - Test Block Bypass House Power Module	65-66
	WSPD - Surge Protection Units	67-68
	WMMB - Aux Pull Box, MS_UBD - Bus Duct Switch mains	69
	Power Mod: Lug Kits, Custom Options, Elbows, & Spacers	70-74
Uni-PAK		
	Intro Page	75
	Features and Benefits	76-77
	WP - No Bypass, Horn Bypass	78-79
	WEP - EUSERC Compliant	80
	WPL - Lever Bypass	81
Power Mod and Uni-PAK: Multifamily Accessories & Replacement Parts		82-85
Multifamily Tenant Circuit Breakers		86

Power Mod Introduction

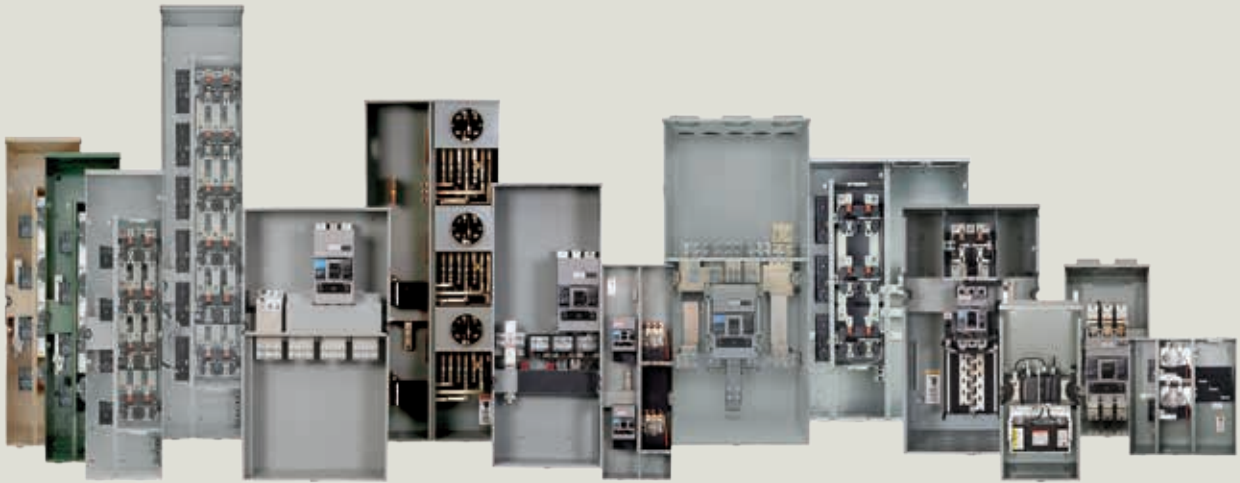

Siemens' Power Mod is a robust, flexible, and feature-rich line of modular metering designed to exceed today's market demands. Power Mod's exclusive QuickSystem has been proven to reduce labor by as much as 43% over comparable solutions while exclusive products, such as the WXB family of cross bus mains, allow for lower material cost and incredible flexibility.

Power Mod is built upon service, quality, and flexibility:
Service: every order is made to order and shipped within a competitive lead time. This means all products arrive at the job site on time and together avoiding multiple shipment delays and confusion.

Quality: Power Mod has been tested to all applicable UL and ANSI standards as well as Siemens own rigorous internal specifications. Power Mod only offers 1200 Amp thru bussing and fully rated vertical bussing in our WMM, WML, and WMT stacks. All of this is delivered at a competitive lead time and price to other, lower rated products.

Flexibility: for Power Mod flexibility goes well beyond exclusive QuickSystem features. For Siemens this means allowing a variety of solutions to any application that can focus on labor savings, material savings, or both! This also means allowing options like custom colors, factory installed tenant breakers, lugs, etc., and the ability to configure Power Mod within the COMPAS configuration tool which allows the user to receive a PDF or DXF file of any custom line up.

Power Mod, when combined with Siemens broad line of load centers and exclusive feature arc fault circuit breakers, offers multiple solutions for any application utilizing the industry's broadest portfolio of multi-family metering solutions.

Power Mod

QuickSystem™ Features

Contractor-focused features, robust quality, dependable service, and exclusive products define Siemens Power Mod. The new standard in multi family metering. QuickSystem showcases the key strengths of Power Mod through five labor saving features:

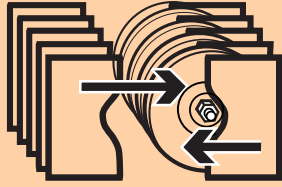

QuickConnect™

A Siemens exclusive feature, QuickConnect reduces bussing connections from many to one - ensuring a single reliable connection instead of multiple connections.

Siemens exclusive feature

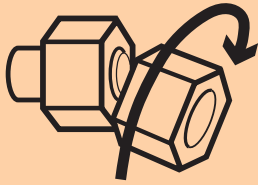

QuickTorque™

QuickTorque eliminates the need for time consuming torque readings. This breakaway nut provides a visual indicator of torque for the QuickConnect. When tightened, the outer head twists off at the proper torque for connection, leaving a single nut for future maintenance.

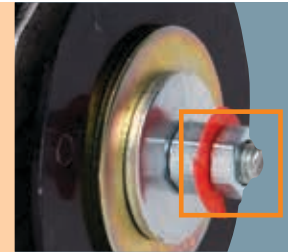

QuickBolt™

A Siemens exclusive feature, QuickBolt eliminates the requirement to line up mechanical connections - instead bolts remain retracted until the openings line up - allowing the bolts to protrude through automatically. Springs push the bolts through and provide positive pressure to keep bolts in place while wingnuts are attached and tightened.

Siemens exclusive feature



QuickRoll™

A Siemens exclusive feature, QuickRoll eliminates typical metal brackets for mounting modules on the wall. Instead of metal scraping metal, QuickRoll allows the module to glide down the mounting rail via a durable nylon wheel inside a mounting bracket.

Siemens exclusive feature

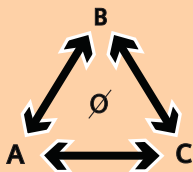

QuickPhase™

Each individual meter position can be phased independently according to the users needs. QuickPhase allows the user the ultimate flexibility to adjust to each individual application.



QuickOption™

Unique to the industry, QuickOption provides the ultimate flexibility in multifamily metering installations. QuickOption enables contractors to meet local specifications and Buy American/ARRA requirements. Custom colors and factory installed options meet needs in virtually every application.



Power Mod Overview of Families



WB - Standard Circuit Breaker Mains

Standard breaker modules (type WB) offer a balance between functionality, feature, and size constraints.

Features include:

- QuickSystem™ features
- Compression lug landing pads (field install up to 1200 Amps, standard feature up to 2000 Amps)
- Combination overhead and underground feed up to 1200 Amps, dedicated overhead or underground feed up to 2000 Amps
- 750kcmil AL wire options
- 65K AIC standard, 100K AIC available for all models
- Removable blank bottom endwall
- Externally accessible breaker handle with padlock capability
- Broad ampacity ratings up to 2000 Amps with non-standard amperages available (such as 700, 900, etc.)
- Field installable shunt trips

Standard Circuit Breaker Mains Quick Reference

- 200-2000A
- 1200A thru-bus rating
- UL Standard # 67
- UL file # E27100
- AIC rating (65k & 100k)
- Voltage:
 - Single phase 120/240V AC max
 - Three phase 240V AC max
- All swing latches and rivets are stainless steel.
- NEMA 3R rated
- G90 galvanized steel
- ANSI 61 paint



WEB - Circuit Breaker-Pullbox Combinations

EUSERC - compliant breaker - pullbox combination modules (type WEB) offer EUSERC compatibility, a wider range of lug options, and extra space for pulling in conductors.

Features include:

- QuickSystem™ features
- Factory installed NEMA II studs
- 750 kcmil AL wire options
- 65K AIC standard, 100K AIC available for all models
- Removable blank bottom endwall
- Externally accessible breaker handle with padlock capability
- Field installable shunt trips
- Large removable ground wire trough with generous space for grounding conductors

Circuit Breaker-Pullbox Combinations Quick Reference

- 200-1200A
- 1200A thru-bus
- UL standard # 67
- UL file # E27100
- AIC rating (65k & 100k)
- Voltage
 - Single phase 120/240V AC Max
 - Three phase 240V AC Max
- All swing latches and rivets are stainless steel
- NEMA 3R rated
- G90 galvanized steel
- ANSI 61 paint
- EUSERC drawing number 347



WXB- Main Breaker Devices Utilizing An Incoming Bus Connection

The WXB family of main breaker devices features incoming and out-going thru bus connections (no incoming lugs). This patented design allows the user to utilize the WXB family to connect to Siemens Sentron Busway or connect to a tap box (or other main) to lower the overall ampacity of the service disconnect. In addition users can now utilize incoming tap boxes to split the service between multiple mains. This can save the end-user on the material cost of the meter bank. Please see the applications pages for more information.

Features include:

- QuickSystem™ features
- Incoming & Outgoing Power Mod thru bus
- 65K AIC standard, 100K AIC available for all models
- Broad ampacity ratings up to 1200 Amps with non-standard amperages available (such as 700, 900, etc...)
- Field installable shunt trip

Cross Bus Mains Quick Reference

- 200-1200A
- 1200A thru-bus rating
- UL Standard #67
- UL file # E27100
- AIC rating (65k & 100k)
- Voltage:
 - Single phase 120/240V AC max
 - Three Phase 240V AC max
- All swing latches and rivets are stainless steel
- NEMA 3R (outdoor)
- G90 galvanized steel
- ANSI 61 paint

Power Mod Overview of Families (cont.)



WBT - Feed Thru Mains

Feed thru mains (type WBT) offer the ability to pull conductors in and out of the enclosure for rise cable or loop feed applications as well as a main breaker device utilizing an incoming and out-going thru bus connections (including incoming lugs). This patented design allows the user to utilize the WBT family to connect to Siemens Sentron Busway. In addition users don't have to utilize any additional tap boxes as lugs are already included in the units. This can save the end-user on the material cost of the meter bank. Please see the applications pages for more information.

Features include:

- QuickSystem™ features
- Incoming & Outgoing PowerMod thru bus
- Standard compression lug capability
- 65K AIC standard, 100K AIC available for all models
- Broad ampacity ratings up to 1200 Amps with non-standard amperages available (such as 700, 900, etc...)
- Field installable shunt trip

Feed Thru Mains Quick Reference

- 200-1200A (breaker)
- 400-2400A (feed thru)
- 1200 thru-bus rating
- UL Standard #67
- UL file #E27100
- AIC rating (65K & 100K)
- Voltage:
 - Three Phase 240V AC max
- All swing latches and rivets are stainless steel
- NEMA 3R (outdoor)
- G90 galvanized steel
- ANSI 61 paint



WS - Standard Switch Mains

Standard switch modules (type WS) are designed for flexibility, space savings, & durability.

Features include:

- QuickSystem™ features
- Standard compression lug capability
- Invertibility: 400-800 Amp devices can be rotated to accommodate the desired incoming feed direction
- 750 kcmil AL wire options for most models
- 100K AIC standard for all models
- Class T fuse provisions
- Front mounted handle - removes the need for spacers on the side
- Broad ampacity ratings up to 1200 Amps

Standard Switch Mains Quick Reference

- 200-1200A
- 1200A thru-bus
- UL Standard # 98
- UL file #E25506
- AIC rating (100k AIC)
- Voltage:
 - Single phase 120/240V AC max
 - Three phase 240V AC max
- All swing latches and rivets are stainless steel
- NEMA 3R rated
- G90 galvanized steel
- ANSI 61 paint



WES - Switch-Pullbox Combinations

EUSERC - compliant switch-pullbox combination modules (type WES) offer EUSERC compatibility, a wider range of lug options, and extra space for pulling in conductors.

Features include:

- QuickSystem™ features
- Factory installed NEMA II studs
- Broad ampacity ratings up to 1200 Amps
- 750kcmil AL wire options
- 100K AIC standard for all models
- Removable blank bottom endwall
- Front mounted handle - removes the need for spacers on the side
- Class T fuse provisions
- Large removable ground wire trough with generous space for grounding conductors
- Extra ground lugs in each device

Switch-pullbox combinations quick reference

- 400-1200A
- 1200A thru-bus
- UL standard # 98
- UL file # E25506
- AIC Rating (100k AIC)
- Voltage:
 - Single phase 120/240V AC max
 - Three phase 240V AC max
- All swing latches and rivets are stainless steel.
- NEMA 3R rated
- G90 galvanized steel
- ANSI 61 paint
- EUSERC drawing numbers 315, 343, and 347

Power Mod Overview of Families (cont.)

MS_UBD- Standardized Busway Connections For Power Mod Switch Modules

The MS_UBD family of switches offers a standardized means of connecting Siemens Sentron busway to Power Mod for mid & high-rise applications. The switch features two sets of thru bus (top and bottom) that allows the user to connect Siemens Sentron Busway (on the top) while the switch powers the Power Mod thru bus (connected on the bottom). The Sentron Busway is connected via the TapStack which converts Sentron busway connections over to Power Mod thru bus connections. This enables the user to connect to Power Mod in as little as 9" of wall space.

Features include:

- Fast connection of end-feed busway to Power Mod meter banks
- Class T fuse provisions
- 100K AIC standard for all models

Pull Box Quick Reference

- 400,600,800 Amp
- 1200 Amp thru-bus rating
- UL Standard #98
- UL file # E25506
- AIC rating: 100K
- Voltage
 - Single phase 120/240V AC max
 - Three Phase 240V AC max
- All swing latches and rivets are stainless steel.
- NEMA 1 construction, G90 galvanized steel with
- ANSI 61 paint

WTB - Standard Tapboxes

Standard tapbox modules (type WTB) are designed for versatility, space savings, and flexibility.

Features include:

- QuickSystem™ features
- Standard compression lug capability
- Invertibility: devices can be rotated to accommodate the desired incoming feed direction
- 750 kcmil AL wire options for most models
- 100K AIC standard for all models
- Broad ampacity ratings from 400 to 2400 Amps
- Line and load capability- service entrance and sub feed rated

Standard Tapbox Quick Reference

- 400-2400A
- 1200A thru-bus rating
- UL Standard # 67
- UL file # E27100
- AIC rating (100K AIC)
- Voltage
 - Single phase 120/240V AC max
 - Three phase 240V AC max
- All swing latches and rivets are stainless steel.
- NEMA 3R rated
- G90 galvanized steel
- ANSI 61 paint



⚠ Restrictions For 1600-2400 Amp Type WTB Power Mod Tap Boxes: ⚠

When the 1600, 2000, or 2400 Amp tap boxes are used as service entrance equipment (fed directly from utility transformer) or when the supply originates from a Class L fuse or Siemens WL circuit breaker there are restrictions on the use of an additional down-stream (thru-bus connected) WTBN, WTB, WET, or WT type Power Mod tap boxes. In these instances a type "WXB" module must be used as protection for the downstream tap box. box (placed between the incoming WTB tap box and the downstream outgoing tap box). See page 18 for an example. This restriction does NOT apply if the tap box is fed from a Siemens Sentron or VL series molded case circuit breaker. Note that the maximum amperage for a Siemens Sentron circuit breaker is 2,000 Amps.

WET - Tapbox - Pullbox Combinations

EUSERC - compliant Tapbox-Pullbox Combination modules (type WET) offer EUSERC compatibility, a wider range of lug options, and extra space for pulling in conductors.

Features include:

- QuickSystem™ features
- Standard compression lug capability
- 750 kcmil AL wire options for most models
- 100K AIC standard for all models
- Broad ampacity ratings from 400 to 1200 Amps
- Removable bottom endwall

Tapbox- Pullbox Combination Quick Reference

- 400-1200A
- 1200 Amp thru-bus rating
- UL Standard #'s 67
- UL file # E27100
- AIC Rating (100k)
- Voltage
 - Single phase 120/240V AC max
 - Three phase 240V AC max
- All swing latches and rivets are stainless steel.
- NEMA 3R rated
- G90 galvanized steel
- ANSI 61 paint
- EUSERC drawing numbers 343, 343A, 347 (Pullbox)



Power Mod Overview of Families (cont.)



WT - Feed Thru Tapbox

Feed-thru tap boxes (type WT) offer the ability to pull conductors in and out of the enclosure for riser cable or loop feed applications.

Features include:

- QuickSystem™ features
- Standard compression lug capability
- 750kcmil Al wire options
- 100k AIC standard
- Removable bottom endwall
- Broad ampacity ratings from 400 to 2400 Amps

Feed Thru Tapbox Quick Reference

- 400-2400A
- 1200A thru bus
- UL Standard #67
- UL file no. E27100
- AIC rating (100k AIC)
- Voltage:
 - Single phase 120/240V AC max.
 - Three phase, 240V AC max
- All swing latches and rivets are stainless steel.
- NEMA 3R rated
- G90 stainless steel
- ANSI 61 paint



Restrictions For 1600-2400 Amp Type WT Power Mod Pull-Thru Tap Boxes:



When the 1600, 2000, or 2400 Amp tap boxes are used as service entrance equipment (fed directly from utility transformer) or when the supply originates from a Class L fuse there are restrictions on the use of an additional down-stream (thru-bus connected) WTBN, WTB, WET, or WT type Power Mod tap boxes. In these instances a type "WXB" module must be used as protection for the downstream tap box (placed between the incoming WT tap box and the downstream outgoing tap box). See page 19 for an example. This restriction does NOT apply if the tap box is fed from a Siemens Sentron or VL series molded case circuit breaker. Note that the maximum amperage for a Siemens Sentron circuit breaker is 2,000 Amps. Please note that Siemens type WL circuit breakers can NOT be used to feed WT Power Mod tap boxes.



WMM - Residential Meter Stacks

Power Mod's core offering of Residential Meter Stacks, type WMM, offers the widest product offering and flexibility in the industry. Each meter stack houses the QuickSystem™ features to maximize productivity and minimize labor costs. To aid in productivity and labor cost reductions our 225 Amp meter stacks feature a new breaker - the "QS". The QS breaker adds to the Siemens exclusive feature set on our new 225 Amp Residential Meter Stacks.

Benefits of the "QS" include:

- An exclusive 6 high 225 Amp meter stack at the same height as our 125 Amp meter stack - 225 to 125 conversion: No conversion kit needed.
- Single right hand bend wiring - saves time and wire
- 100K AIC offered from 100 up to 225 Amps

Siemens Residential Meter Stacks are packed with features inside and out: our exclusive knock out plate offers flexibility when pulling wires to the stack, breaker supports keep breakers level and straight, moveable neutrals and grounds to save wire, and all of the QuickSystem features all designed with the contractor in mind.

Residential Meter Stacks Quick Reference

- 2-6 gang
- 125/225 Amp per position
- 1200 Amp thru-bus rating
- UL Standard #67 & #414
- UL file no. E27100
- AIC rating (65k & 100k)
- Voltage:
 - Single phase 120/240V AC max.
 - Three phase in single phase out
 - 120/208V AC max.
 - 240/120V AC max.
- All swing latches and rivets are stainless steel.
- Outdoor= NEMA 3R rated
- Indoor= NEMA 1 rated
- G90 galvanized steel
- ANSI 61 paint



WML - Lever Bypass Meter Stacks

Commercial Lever Bypass meter stacks (type WML) are designed to meet the requirements of those utilities specifying lever bypass meter sockets for residential and commercial applications.

Features include:

- QuickSystem™ features
- High-quality, time-proven Talon HQ sockets
- A line of 3-phase 100 Amp meter stacks to minimize tenant main cost
- Removable back knockout plate to facilitate wiring
- 225 Amp capability in single and three phase designs
- Up to 4 positions with 225 Amp tenant mains, up to 2 positions with 400 Amp tenant mains
- Ease of wiring – tenant mains require only a single bend

Lever Bypass Quick Reference

- 100A/225A 1-4 position
- 400A 1-2 position
- 1200A thru-bus rating
- UL Standard # UL67
- UL file # E27100
- AIC rating (25K, 65K & 100K)
- Voltage
 - Single phase 120/240V AC max
 - Three in single phase out 208Y/120V AC
 - Three Phase 240V AC max
- All swing latches and rivets are stainless steel.
- Outdoor = NEMA 3R rated
- Indoor = NEMA 1 rated
- G90 galvanized steel
- ANSI 61 paint

Power Mod Overview of Families (cont.)



WML - Fusible Switch Lever Bypass Meter stacks
This Commercial Lever Bypass meter stacks (type WML) feature a 400 Amp - class T - fusible pull out assembly.

- Features include:
- QuickSystem™ features
 - High-quality, time proven Talon HQ sockets
 - Removable back knockout plate to facilitate wiring
 - Available in single and three phases designs
 - Single position with 400 Amp tenant main
 - Ease of wiring

Lever Bypass With Fusible Switch Quick Reference:

- 400A 1 position
- 1200A thru bus rating
- UL Standard #UL67
- UL file #E27100
- AIC rating 65KAIC
- Voltage:
 - Single phase 120/240V AC max
 - Three phase in, single phase out 208Y/120V AC
 - Three Phase 240V AC max
- All swing latches and rivets are stainless steel
- Outdoor= NEMA 3R rated
- Indoor= NEMA 1 rated
- G90 galvanized steel
- ANSI 61 paint



WMLZ/ WMLZF - Fusible Residential Lever Bypass Meter Stacks

The WMLZ and WMLZF lever bypass meter stacks are designed to allow the use of class T (400 Amp max) fuses ahead of all meter positions where the local serving utility may require it. WMLZF stacks feature a 400 Amp fusible pull out assembly which connects to a secondary 400 Amp thru bus that can feed downstream meter stacks. The WMLZ stacks include the secondary thru bus that can connect from the WMLZF meter stacks. The standard Power Mod 1200amp thru bus "passes thru" to feed downstream modules – the meter sockets in WMLZ and WMLZF do NOT connect directly to the 1200 Amp thru bus – only to the 400 Amp thru bus.

- Features include:
- QuickSystem™ features
 - High-quality, time proven Talon HQ sockets
 - 125 Amp capability for 3-phase in/ single-phase out
 - 3 to 6 positions in both the fused stack and the expansion stack
 - 400 Amp class T fusible-pullout in WMLZF stacks
 - Secondary 400 Amp thru bus to supply power to downstream sockets
 - Ease of wiring – tenant mains require only a single bend
 - Preconfigures and wired.

Xcel Residential Lever Bypass Quick Reference:

- 125A 3-6 position
- 1200A thru bus rating
- 400A secondary thru-bus rating & vertical bus rating
- UL Standard #UL67
- UL file #E27100
- AIC rating (100K)
- Voltage
 - Three phase in, single phase out 208Y/120V AC
- All swing latches and rivets are stainless steel
- Outdoor = NEMA 3R rated
- Indoor = NEMA 1 rated
- G90 galvanized steel
- ANSI 61 paint
- Custom options available



WMT - Test Block Bypass Meter Stacks
Commercial Test Block Bypass Meter Stacks (type WMT) are designed to meet the requirements of those utilities specifying test block bypass meter sockets for commercial applications in areas subscribing to the EUSERC standards.

- Features include:
- QuickSystem™ features
 - High-quality, time-proven Siemens SMM switchboard meter socket
 - Removable back knockout plate to facilitate wiring
 - 225 Amp capability in single and three phase designs
 - Up to 3 positions with 225 Amp tenant mains
 - Wiring flexibility - tenant mains require only a single bend
 - Three phase input, single phase output modules
 - In line wiring: side knockouts allow wiring for adjacent units to pass through

Test Block Bypass Quick Reference

- 225A 1-3 positions
- 1200A thru-bus rating
- UL Standard #'s 67
- UL file # E27100
- AIC Rating (100k)
- Voltage
 - Single phase 120/240V AC max
 - 3 phase in single phase out 120Y/208V AC max
 - Three phase 240V AC max
- All swing latches and rivets are stainless steel
- Outdoor= NEMA 3R rated
- Indoor= NEMA 1 rated
- G90 galvanized steel
- ANSI 61 paint
- EUSERC drawing numbers 312 and 353

Power Mod Overview of Families (cont.)



WSPD- Integral Surge Protection Device For Multi-Family Applications

Surge protection modules for Power Mod (type WSPD) are thru-bus connected modules that allow the user to view surge status as well as access the SPD control panel without breaking the utility seal on the enclosure. An optional breaker disconnect is available to enable the end user to replace the SPD (surge protection device) without having to disconnect utility power to the Power Mod installation.

Features include:

- QuickSystem™ features
- 100,200,300,400,500kA ratings available
- External, vandal resistant & lockable clear cover over SPD control panel
- Single phase thru bus and three phase thru bus
- Optional breaker disconnect that opens phase & neutral to make SPD replacement quick and easy

Surge Module Quick Reference

- 100-500kA ratings available
- 1200A thru-bus rating
- UL Standard #67
- UL file # E27100
- AIC rating: 100K
- Voltage
 - Single phase 120/240V AC max
 - Three Phase 240V AC max
- All swing latches and rivets are stainless steel.
- NEMA 3R rated
- G90 galvanized steel
- ANSI 61 paint



WMK - K-Base Meter Stacks

Commercial K-Base Meter Stacks (type WMK) are designed to meet the requirements of those utilities specifying bolt-in meter sockets for 400 and 600 Amp residential and commercial applications.

Features include:

- QuickSystem™ features
- Exclusive Talon K4, K5, & K7 meter sockets
- 1 position K4, K5, K7 modules with 400 & 600 Amp tenant mains
- 2 position K7 module with 400 Amp tenant main
- Space saving design

K-Base Quick Reference

- 400A & 600A 1-2 positions
- 1200A Thru bus-rating
- UL Standard # 67
- UL file # E27100
- AIC Rating (25k)
- Voltage
 - Single Phase 120/240V AC Max
 - Three In Single Phase Out 208Y/120V AC
 - Three Phase 240V AC Max
- All swing latches and rivets are stainless steel
- NEMA 3R rated
- G90 galvanized steel
- ANSI 61 paint



WMMB- Auxillary Pull Boxes For Use With WB, WTB, And WS Power Mod Modules

Auxillary pull boxes are used in cases where WEB, WES, or WET modules were not or cannot be used, but the user still needs to comply with the EUSERC standard. These modules feature incoming NEMA II stud pattern lugs for underground feed and allow the user to pull wire from the lug landing in the pull box thru a 6" knockout and into: 400-1200amp WB, WTB and 400-800amp WS modules. Note this family does NOT have any thru bus.

Features include:

- 6" side opening (right or left) with available gasket to help mitigate wire insulation damage
- EUSERC compliant incoming pull section
- Dual cover handles
- Single and three phase models

Pull Box Quick Reference

- 400, 800,1200 Amp
- UL Standard #67
- UL file # E27100
- AIC rating: 100K
- Voltage
 - Single phase 120/240V AC max
 - Three Phase 240V AC max
- All swing latches and rivets are stainless steel.
- NEMA 3R rated
- G90 galvanized steel
- ANSI 61 paint

Power Mod Overview of Families (cont.)



WC - Residential Meter Socket With Load Center Distribution Panel

The meter-load center combination offered by the WC series is unique and exclusive to the Siemens Power Mod family. This product offers the ability to combine house power applications with a meter socket thereby reducing material (pipe and wire) and installation time (separate load center or panel board).

Features include:

- QuickSystem™ features
- Ring or ringless style covers. Ringless available with horn bypass
- Single phase thru bus and three phase thru bus
- 20 space - 40 circuit interior for single phase out put devices
- 24 space - 42 circuit interior for three phase out put devices
- Copper bus PL Series Siemens load center interior
- Dual neutral & ground provisions with Siemens patented Instawire technology
- Optional subfeed breaker for elevator applications
- 250 Amp overall device rating

WC House Power Panel Quick Reference:

- 250 Amp, 1 position
- 1200 Amp thru-bus rating
- UL Standard #67
- UL Standard #414
- UL file # E27100
- AIC rating: 100K
- Voltage
 - Single phase 120/240V AC max
 - Three in single phase out 208Y120V AC
 - Three Phase 240V AC max
- All swing latches and rivets are stainless steel
- NEMA 3R rated
- G90 galvanized steel
- ANSI 61 paint
- Copper load center bus bars
- 125 Amp MAX subfeed breaker- factory installed (type HED4)
- 225 Amp MAX main breaker- factory installed (type HFD6)



WCL- Commercial Lever Bypass Meter Socket With Load Center Distribution Panel

The meter-load center combination offered by the WCL series is unique and exclusive to the Siemens Power Mod family. This product offers the ability to combine house power applications with a meter socket thereby reducing material (pipe and wire) and installation time (separate load center or panel board). WCL modules feature the Talon HQ lever bypass for those utilities that specify lever bypass for residential and commercial applications.

Features include:

- QuickSystem™ features
- Ringless style covers with high-quality, time-proven Talon HQ meter socket
- Single phase thru bus and three phase thru bus
- 20 space - 40 circuit interior for single phase out put devices
- 24 space - 42 circuit interior for three phase out put devices
- Copper bus PL Series Siemens load center interior
- Dual neutral & ground provisions with Siemens patented Instawire technology
- Optional subfeed breaker for elevator applications
- 250 Amp overall device rating

WCL House Power Panel Quick Reference:

- 250 Amp, 1 position
- 1200A thru-bus rating
- UL Standard #67
- UL Standard #414
- UL file # E27100
- AIC rating: 100K
- Voltage
 - Single phase 120/240V AC max
 - Three in single phase out 208Y120V AC
 - Three Phase 240V AC max
- All swing latches and rivets are stainless steel
- NEMA 3R rated
- G90 galvanized steel
- ANSI 61 paint
- Copper load center bus bars
- 125 Amp MAX subfeed breaker- factory installed (type HED4)
- 225 Amp MAX main breaker- factory installed (type HFD6)



WCT- Commercial Test Block Bypass Meter Socket With Load Center Distribution Panel

The meter-load center combination offered by the WCT series is unique and exclusive to the Siemens Power Mod family. This product offers the ability to combine house power applications with a meter socket thereby reducing material (pipe and wire) and installation time (separate load center or panel board). WCT modules feature a test block bypass socket for utilities subscribing to the EUSERC standard.

Features include:

- QuickSystem™ features
- Ring style covers with high-quality, time-proven Siemens SMM switchboard meter socket
- Single phase thru bus and three phase thru bus
- 20 space - 40 circuit interior for single phase out put devices
- 24 space - 42 circuit interior for three phase out put devices
- Copper bus PL Series Siemens load center interior
- Dual neutral & ground provisions with Siemens patented Instawire technology
- Optional subfeed breaker for elevator applications
- 250 Amp overall device rating

WCT House Power Panel Quick Reference:

- 250 Amp, 1 position
- 1200 Amp thru-bus rating
- UL Standard #67
- UL Standard #414
- UL file # E27100
- AIC rating: 100K
- Voltage
 - Single phase 120/240V AC max
 - Three in single phase out 208Y120V AC
 - Three Phase 240V AC max
- All swing latches and rivets are stainless steel
- NEMA 3R rated
- G90 galvanized steel
- ANSI 61 paint
- Copper load center bus bars
- 125 Amp MAX subfeed breaker- factory installed (type HED4)
- 225 Amp MAX main breaker- factory installed (type HFD6)

Power Mod: Configuration Tips

The breadth of the Power Mod product line is un-matched in the industry today. The available options result in many different ways to configure the same project with some solutions focusing on material cost and other solutions that create the opportunity for labor savings. The following pages contain examples and tips for using Power Mod in common multi-family metering applications including, but not limited to high rise buildings, mixed use, and garden style apartment complexes.

The following items are configuration tips and rules to keep in mind:

Ampacity & Bussing

Configurations are limited by the continuous current ratings for the main device (service entrance) and the thru bus. The Power Mod thru bus is always rated for 1200 Amps from the factory. Siemens does not offer low 800 Amp rated thru bus. All thru bus within the same meter bank must be single phase or three phase. Single and three phase thru bus cannot be mixed within the same meter bank.

Connections

A QuickConnect is required for each thru bus connection and is supplied with all WMM, WML, WMT, WC, WCL, WCT, WSPD, and WMK meter stacks. The QuickConnect houses all phase, neutral, ground/bonding connections between Power Mod modules.

Utility Requirements

Utilities have varying requirements for equipment height, cover types, and bypass types. Therefore, utility acceptance should be verified prior to installation of any equipment. The COMPAS configuration tool can be utilized by any authorized Siemens sales or distributor representative to show critical dimensions of any installation.

Service Entrance Modules & Requirements

- Modules over 1200 Amps: Mains over 1200 Amps are required to be center fed (IE main must have a module on both sides). The current out of any given side cannot exceed 1200 Amps. For a 2000amp WB style main, for example, the user can elect to feed 1200 Amps out of the right or left, but not both.
- EUSERC-compliant service entrance modules (families WEB, WES, WET) are underground feed only and offer a wider range of lug options due to the larger enclosure size. These devices are also setup for compression lug installations from the factory.
- Tapboxes (families WTB, WT, WET) provide a direct connection to the thru bus and do not provide any overcurrent protection. These families should never be used to feed other main devices that have incoming lugs (families WB, WEB, WS, WES). A tapbox CAN be used with the WXB cross bus main family. All tapbox families can be used as a service entrance point or a load side feed for remote equipment. An additional QuickConnect must be ordered separately when using a tap box on the load side. The WTB family features invertibility on 400 - 1600 Amp models. Each item from this family includes two sets of QuickBolts. The eventual left side must be removed prior to installation.

- WB service entrance breaker modules: 200 thru 1200 Amp modules are combination feed allowing service entrance conductors to enter the top or bottom of the enclosure. 1400-1600 Amp WB modules come in top or bottom feed (combination feed is not available). 2000 Amp WB modules are available in dedicated bottom feed or combination feed configurations.
- WS service entrance switch modules: 400 to 800 Amp modules are invertible for top or bottom feed. Each includes two sets of QuickBolts. The eventual left side must be removed prior to installation. 1200 Amp WS modules are bottom feed only and utilize a molded case switch (looks like a breaker) for the switching mechanism.

Spacing Requirements

A spacer is commonly required between a meter stack and a service entrance module. This is usually due to the need to have a minimum distance (left or right) from the meter to any obstruction. TIP: when the service entrance main is on the LEFT and you need a 125 Amp tenant main WMM stack use a 225 Amp WMM meter stack instead. The extra width of the 225 Amp stack will provide 10" of clearance from the main and, since you can use a standard Q2100 or Q2125 in the stack, the cost increase from 125 to 225 Amp is still less than adding a spacer (type WSP). This also saves the installation labor of the spacer.

Breaker Provisions

A tenant breaker must be ordered separately for each tenant position or configured as factory installed within the COMPAS configuration tool. Blank filler plates are not available thus un-used positions must have a breaker installed or the access cover must be locked.

Space Savings

Utilize the WC-WCL-WCT families to save space. These devices allow for consolidating the typical setup of a meter stack + separate panel into a single device if the application. This allows for less wall space, increased material savings, and a lower install cost. Please see the configurations on the following pages for examples.

Material Savings

utilize the WXB cross bus mains to lower your overall material cost. When a large ampacity main is needed (1200 Amps or above) utilizing a tap box and a WXB main can lower the overall cost by eliminating costly large frame breakers from the installation. As shown in figures 3 & 4 the installation does require more wall space, but the overall dollars are lower.

Applications: Typical Configurations

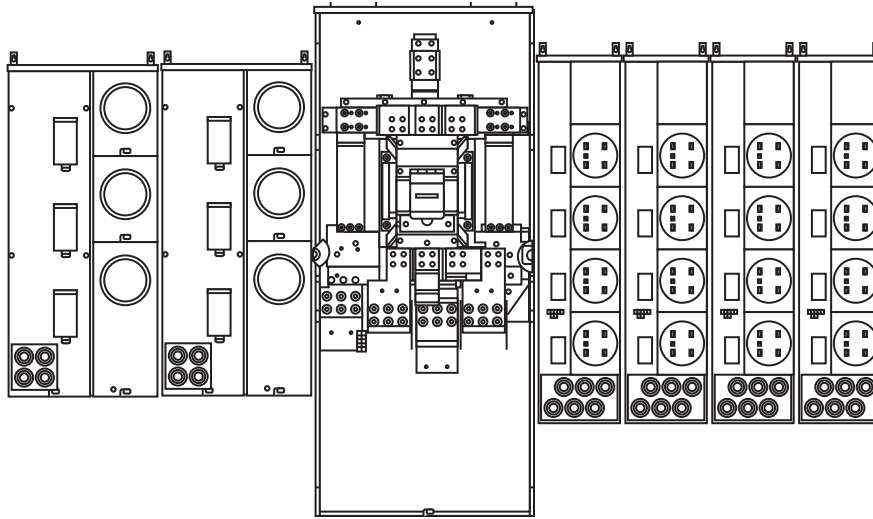

Figure 1

Incoming Service: 1600 Amps

Details: This installation requires a center fed main because the incoming service is over the thru bus rating of 1200 Amps.

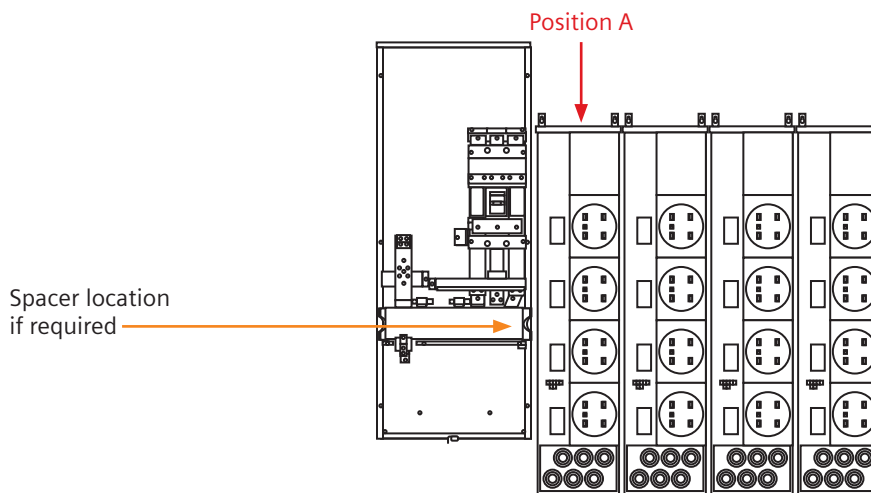

Figure 2

Incoming Service: 1200 Amps

Details: This installation is shown as end feed from the left, but could be right or center fed as well since the main service does not exceed 1200 Amps. In this case if a spacer (family WSP) were required it would go between the WB module and the WMM stack labeled "Position A". Another option would be to utilize a 225 Amp WMM stack in position A thereby eliminating the need for the spacer and lowering the overall cost.

Applications: WXB Family of Cross Bus Mains

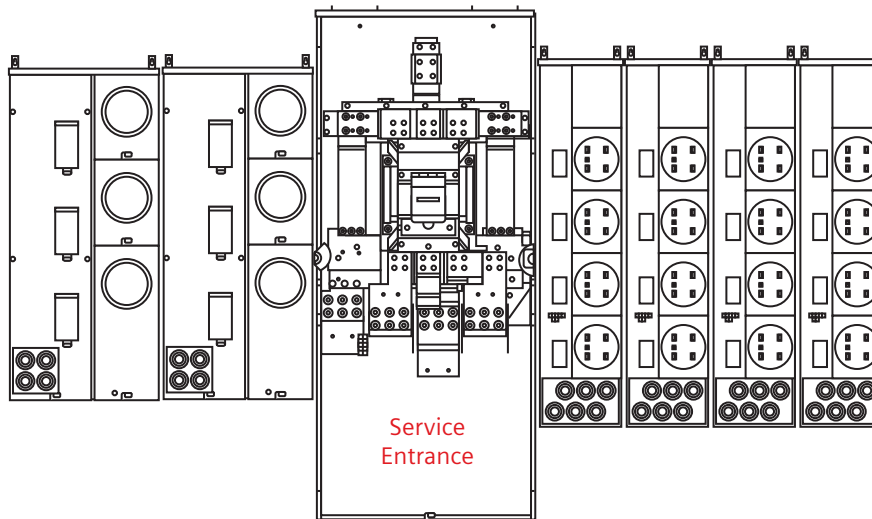

Figure 3

Incoming Service: 1600 Amps

Details: The installation above has a 1600 Amp 3 phase WB main (WB31600B) which is feeding WML321225RJ stacks to the left and WMM42125RJ stacks to the right. Overall it has a width of 130.7" and has a list price of \$15,366.^①

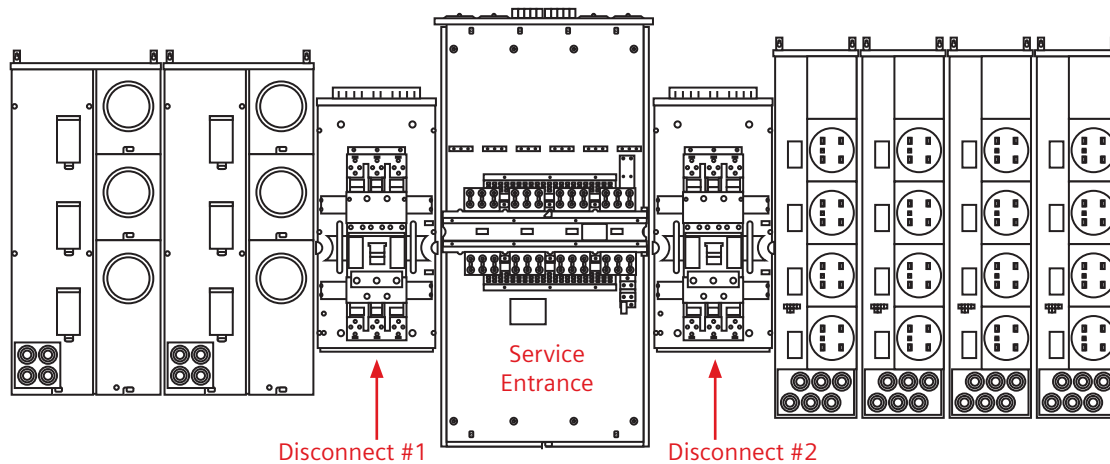

Figure 4

Incoming Service: 1600 Amps

Details: This installation can meet the same application as Figure 3 above, but replaces the 1600 Amp WB main with a tap box (WT31600PU in this case). The service disconnects are labeled #1 and #2 above. By dividing the incoming current into 2 mains- even though more modules were added- the overall list price DROPS to \$13,982. Width grows by 31", BUT there is now a 9% savings on material!^①

^① Pricing subject to change without notice.

Applications: WXB Family of Cross Bus Mains

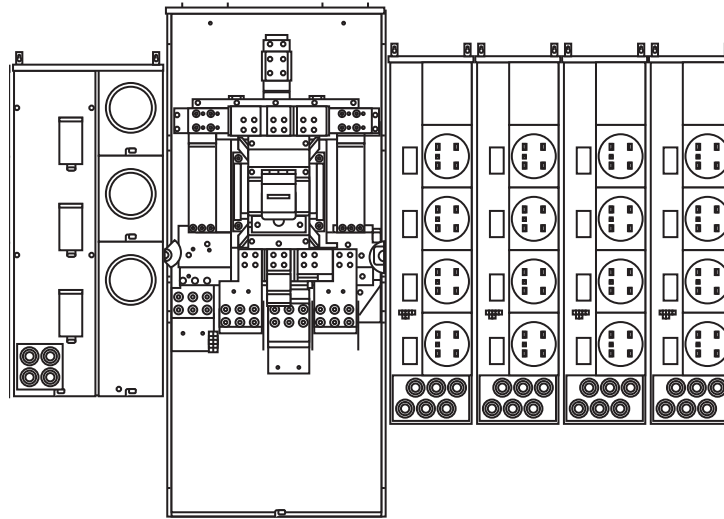

Figure 5

Incoming Service: 1600 Amps

Details: The installation above has a 1600 Amp 3 phase WB main (WB31600B) which is feeding a WML321225RJ stack to the left and WMM42125RJ stacks to the right.

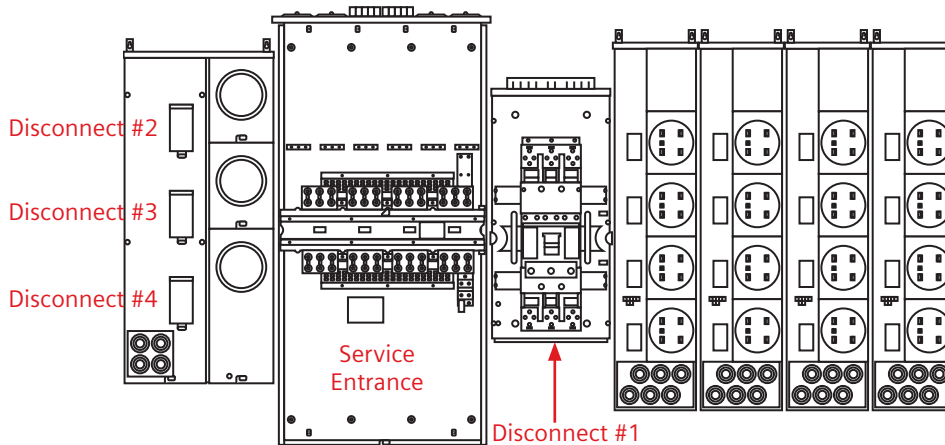

Figure 6

Incoming Service: 1600 Amps

Details: This installation can meet the same application as Figure 5 above, but replaces the 1600amp WB main with a tap box (WT31600PU in this case). The right side utilizes the new WXB31200N cross bus main. The left side works off of the six disconnect rule. In removing the 1600 Amp WB and adding the WXB the width grew by 8", but the list price drops by over 20% offering a tremendous savings on material. Another option would be to utilize a WB main breaker to feed a remotely mounted CT cabinet. The overall application remains the same- taking the large 1600amp incoming service and splitting it between 2 main disconnects.

Applications: WBT – Feed Thru Main

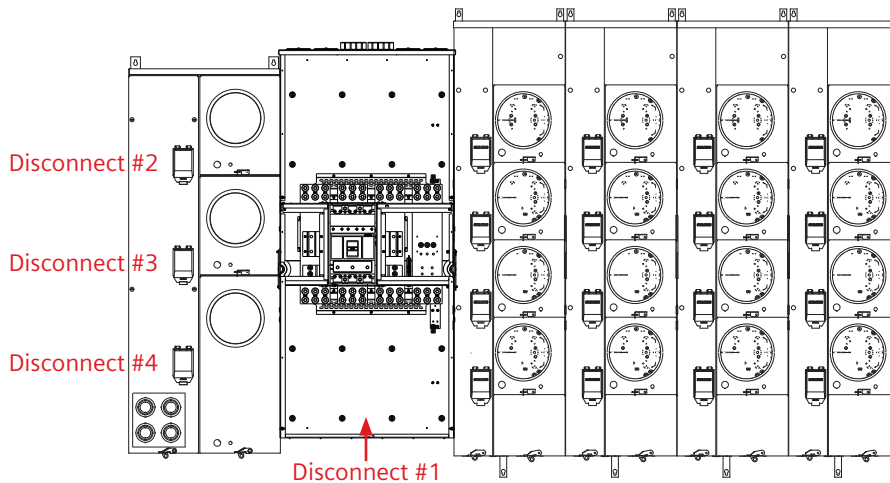

Figure 7

Incoming Service: 1600amps

Details: This installation can meet the same application as figure 6, but combines the tap box (WT31600PU in this case) and the Cross Bus Main (WXB31200N). The left side works off the 6 disconnect rule. In removing the 1600A WB and combining the tap box and the Cross Bus Main, we reach a smaller footprint and a list price drops offering a tremendous savings on material and space.

Applications: WMLZ/ WMLZF – Fusible Residential Lever Bypass Meter Stacks

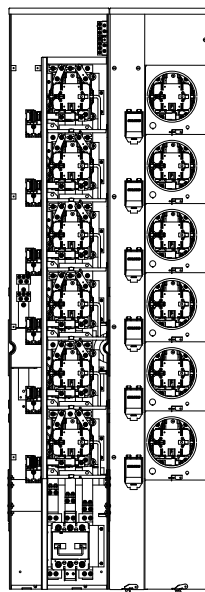

Figure 8

Incoming Service: 400amps

Details: This installation meets the Xcel Residential Lever Bypass utility requirements with a WMLZF (WMLZF62125RJ) featuring 125A 6-position and a 400amp fusible pull out assembly which connects downstream to a WMLZ stacks (WMLZ62125RJ) which include a secondary 400 amp thru bus.

Applications: WMLZ/ WMLZF – Fusible Residential Lever Bypass Meter Stacks

Flow of Current



- 1 Cables land on a tap box and current enters Power Mod line up on the main Thru Bus.
- 2 Current is directed from the main thru bus down onto the WMLZF's vertical bus and into the 400 amp fuse pull out.
- 3 The current then goes up on the WMLZF's vertical bus to feed the sockets.
- 4 WMLZ's must be fed by a secondary thru bus from the WMLZF's
*Additional connections are required between the WMLZ and WMLZF.
- 5 The current then flows up from the secondary thru bus and on to the vertical bus to feed the sockets in the WMLZ's.
*More than one WMLZ can be fed from 1 WMLZF.
- 6 The main thru bus is used as a pass thru on the WMLZ's for any additional modules attached to the line up.
*Quick Connect MUST be used between every module to maintain the line ups Neutral bonding, even if there are no extra modules attached at the end of the line up..

Applications: WC-WCT-WCL House Power Modules

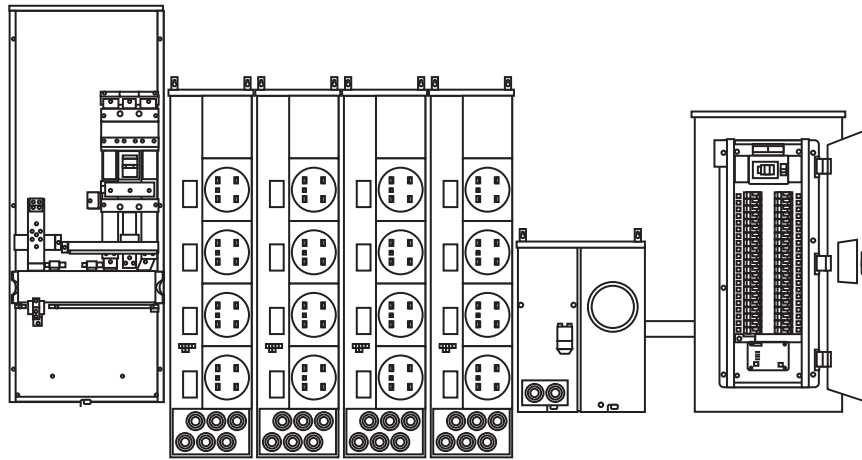

Figure 9

Incoming Service: 1200 Amps

Details: The installation above has a 1200 Amp 3 phase WB main (WB31200C) feeding WMM residential stacks and a WML-13225RJ (1) position commercial meter stack. The WML is feeding a P1 lighting panel approximately 2' away. The P1 is the house power panel.

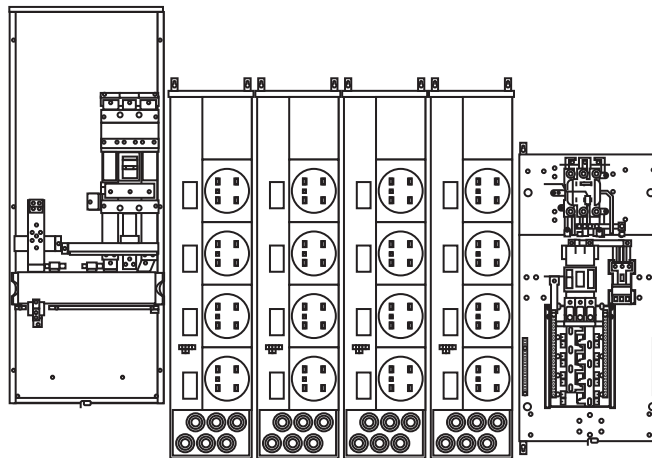

Figure 10

Incoming Service: 1200 Amps

Details: This is the same application as figure 7 shown above, however the WCL house power module now takes the place of both the WML and the P1. The WCL is rated for up to 250Amps and can accommodate 40 circuits + 1 subfeed breaker of up to 125 Amps. The WCL, in this application, saves over 4 FEET of wall space plus lowers the material cost for the application by 15%! The WCL in this case could also be a WCT or WC. This application simplifies smaller house power needs such as parking lot lighting, common area lighting, or club houses.

Applications: Bus Duct Connections

Busway application

Siemens Power Mod offers an efficient and standardized means of connecting Sentron Busway to Power Mod utilizing the TapStack module. This module connects to a joint in the busway and converts the bus structure over to that of the Power Mod thru bus in only nine inches.

TapStacks are configured, priced, built, and shipped with the Sentron Busway. They require an additional QuickConnect coupler and are for indoor use on end-feed applications. TapStacks can connect to any Power Mod thru bus. Options for the user are:

Direct Connection: in this option (see figure 10) the connection is made directly to any meter stack family. This application is for use when the service disconnect is located at the beginning of the busway.

Connection to a service disconnect: in this option (see figure 9) a connection is made to either a WXB cross bus main or a MS_UBD switch main. Please note that ANY other mains (WB, WEB, WS, WES) cannot act as a service disconnect for downstream meter stacks. The WB, WEB, WS, WES mains CAN be used as tenant mains on the load-side of a service disconnect for use in feeding large remote loads such as a CT cabinet. WXB mains are available up to 1200Amps and MS_UBD mains are available up to 800Amps. Both families have 100K AIC options.

Connection to a load-side main: In applications where branch circuit monitoring is used in lieu of Power Mod a tap stack plus Power Mod main (WB, WS) can be used where the installer cables out of the main over to a distribution panel (Siemens P3, P4, and P5 panel types). This essentially replaces a bus plug function. See Figure 11.

For Center feed bus duct application please contact your Siemens representative.

Critical & recommended dimensions for Sentron Busway to Power Mod connections

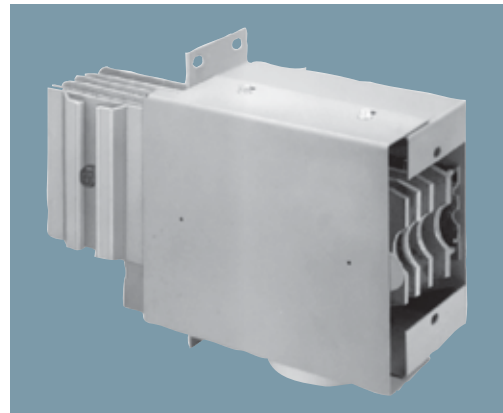
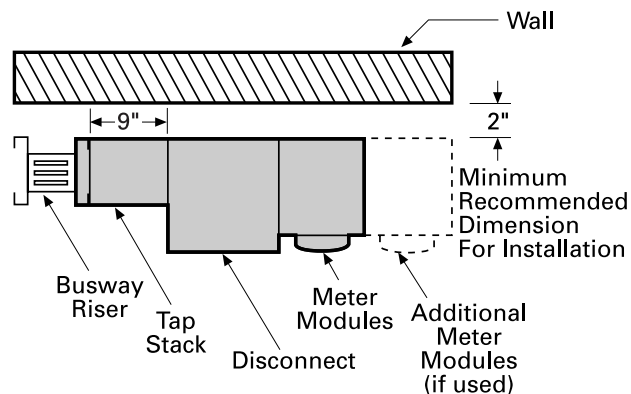

Tap Stack Module

Applications: Bus Duct Solutions

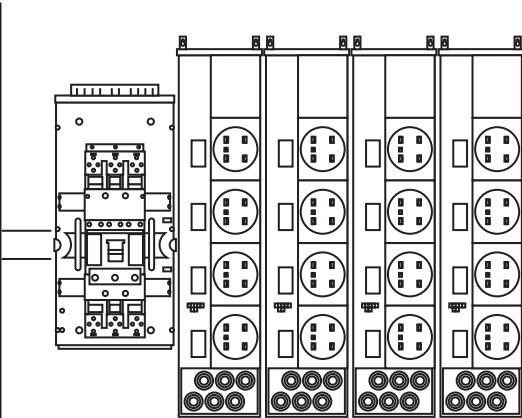

Figure 11
Incoming Service: 1200 Amps
Details: The drawing to the left shows how a WXB main can be utilized in bus duct applications. Using the Sentron Busway TapStack the contractor can easily bus directly to PowerMod in as little as 9”.

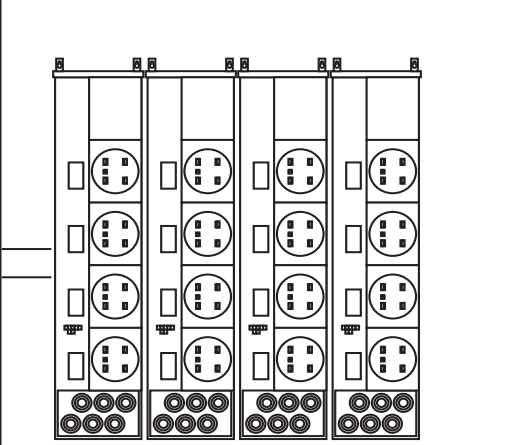

Figure 12
Incoming Service: up to 1200 Amps
Details: The drawing to the left shows how the Siemens Sentron Busway TapStack can be connected directly to Power Mod WMM stacks when approved by the local inspection authorities.

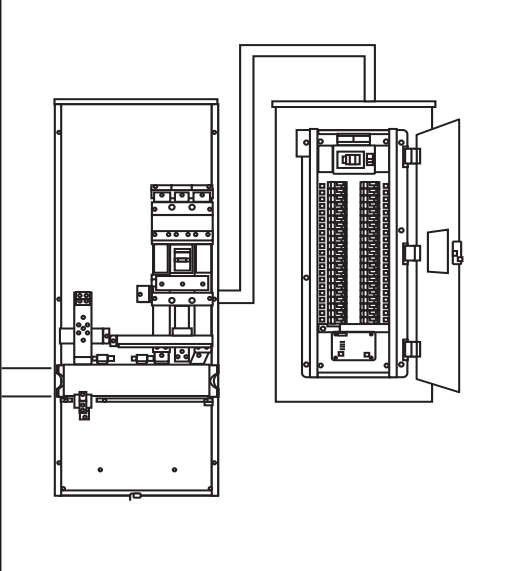
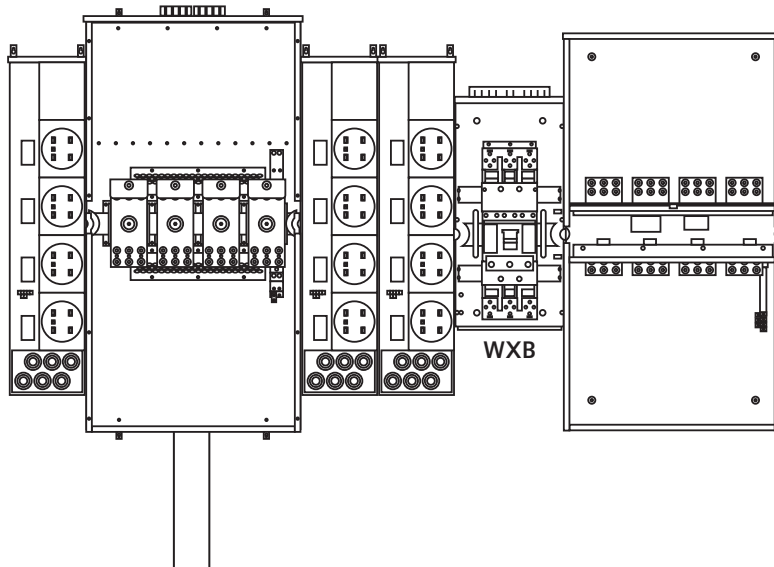

Figure 13
Incoming Service: 1200 Amps
Details: Some applications require tapping off of the busway to provide power to a panel. In these cases a TapStack and WB Power Mod main can offer a lower cost alternative to busplugs. This allows the user to order riser duct instead of plug-in duct and avoid having to seal un-used openings.

Applications: WTB Tap Boxes 1600 – 2400 Amps (when used with load side tap boxes WT or WTB)

Figure 14



- Siemens Type WL Circuit Breaker
- Class L fuse
- Service Entrance (direct from utility transformer)①

✓ This application shown **IS** allowed because the tap box has circuit protection via the WXB main.

Figure 15

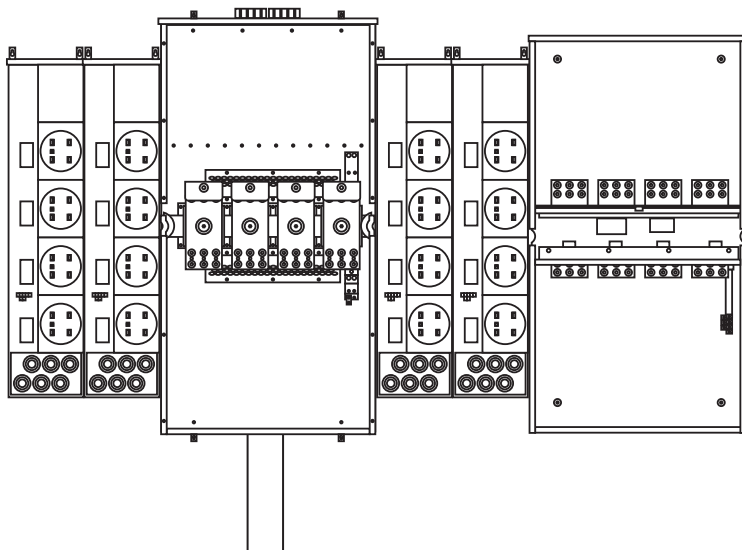

- Siemens Type WL Circuit Breaker
- Class L fuse
- Service Entrance (direct from utility transformer)①

✗ The application shown is **NOT** allowed. A down stream WT or WTB tap box requires circuit protection in the form of a WXB Main.

① Drawings are for illustrative purposes only.

Applications: WT Tap Boxes 1600 – 2400 Amps

Figure 16

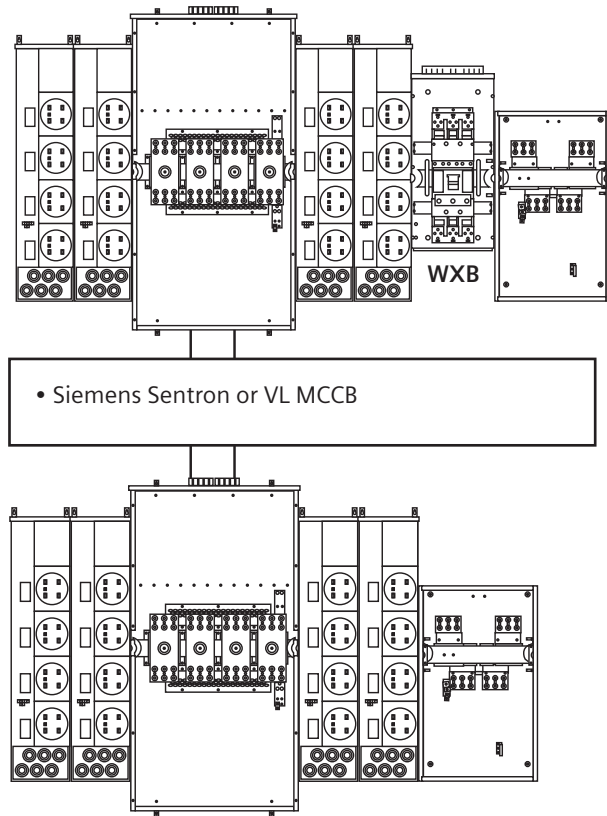

✓ Either of the applications shown are acceptable due to the presence of the VL or Sentron MCCB

Figure 17

✗ The application shown is **NOT** allowed. A down stream WT or WTB tap box requires circuit protection in the form of a WXB Main.

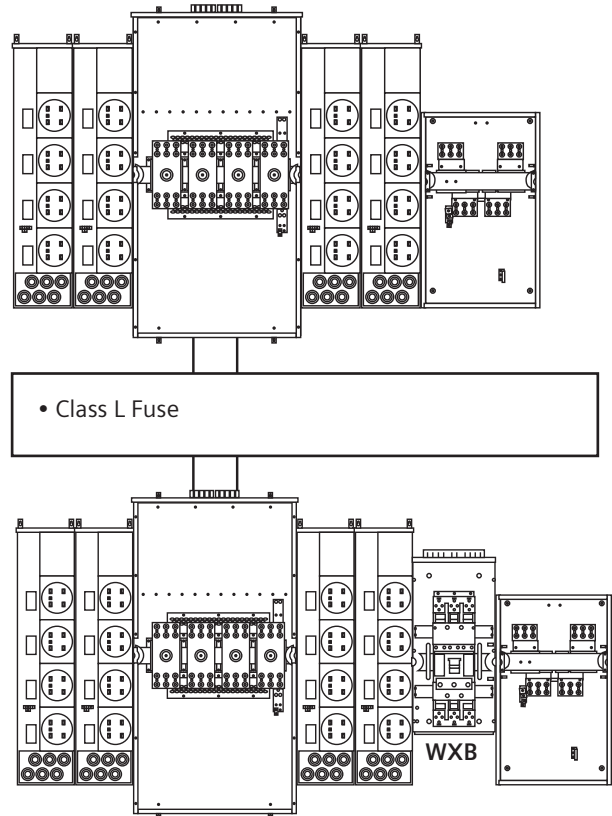

✓ This application shown **IS** allowed because the tap box has circuit protection via the WXB main.

✗ A type WL circuit breaker cannot be used to feed a WT series tap box. Additionally WT tap boxes are not rated for service entrance.

⚠

Figure 18

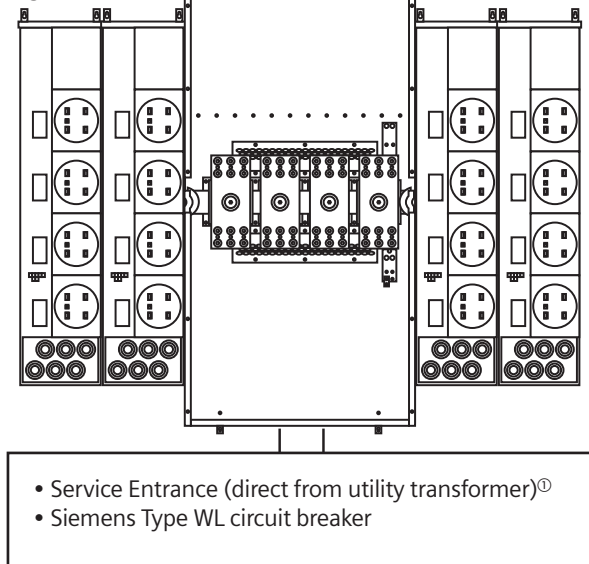

① Drawings are for illustrative purposes only.

Power Mod: Standard Circuit Breaker Mains

Standard breaker modules (type WB) offer a balance between functionality, feature, and size constraints.

Features include:

- QuickSystem™ features
- Compression lug landing pads (field install up to 1200 Amps, standard feature up to 2000 Amps)
- Combination overhead and underground feed up to 1200 Amps, dedicated overhead or underground feed up to 2000 Amps
- 750kcmil AL wire options
- 65K AIC standard, 100K AIC available for all models
- Removable blank bottom endwall
- Externally accessible breaker handle with padlock capability
- Broad ampacity ratings up to 2000 Amps with non-standard amperages available (such as 700, 900, etc.)
- Field installable shunt trips

Standard Circuit Breaker Mains Quick Reference

- 200-2000A
- 1200A thru-bus rating
- UL Standard # UL67
- UL file # E27100
- AIC rating (65k & 100k)
- Voltage:
 - Single phase 120/240V AC max
 - Three phase 240V AC max
- All swing latches and rivets are stainless steel
- NEMA 3R rated
- G90 galvanized steel
- ANSI 61 paint
- Custom options available! Details on p. 72



Power Mod: Type WB Standard Circuit Breaker Mains

Factory installed lugs are standard on 200-1200A standard breaker main modules. Additional lug kit options are available for 750 conductor size. Refer to page 60-61 for lug kit options on 200-1200A standard main breakers. In addition, a field installable compression lug landing pad is also available. Refer to pages 60-61 & 71 for lug landing pad options. NEMA II Stud Pattern compression lugs must be installed by user or utility.

Lugs are NOT included on 1400A-2000A standard breaker main modules and must be ordered separately. Refer to pages 60-61 for lug size options.



Circuit Breaker Service Entrance Modules: 1-Phase, 3-Wire SN, 120/240V AC

Catalog Number (65k AIC) ^①	Catalog Number (100k AIC) ^②	Ampere Rating	Service Feed	Breaker Type ^③	Dimensions (inches) ^④			Factory Installed Line Side Connections
					Height	Width	Depth	
WB1200C ^②	WB1200CU	200	OH/UG	JXD6	39.19	15.20	11.03	(2) 3/0-500 kcmil CU (2) 4/0-500 kcmil AL
WB1250C ^②	WB1250CU	250	OH/UG	JXD6	39.19	15.20	11.03	(2) 3/0-500 kcmil CU (2) 4/0-500 kcmil AL
WB1300C ^②	WB1300CU	300	OH/UG	JXD6	39.19	15.20	11.03	(2) 3/0-500 kcmil CU (2) 4/0-500 kcmil AL
WB1350C ^②	WB1350CU	350	OH/UG	JXD6	39.19	15.20	11.03	(2) 3/0-500 kcmil CU (2) 4/0-500 kcmil AL
WB1400C	WB1400CU	400	OH/UG	JXD6	39.19	15.20	11.03	(2) 3/0-500 kcmil CU (2) 4/0-500 kcmil AL
WB1450C ^②	WB1450CU	450	OH/UG	LXD6	39.19	15.20	11.03	(2) 3/0-500 kcmil CU (2) 4/0-500 kcmil AL
WB1500C ^②	WB1500CU	500	OH/UG	LXD6	39.19	15.20	11.03	(2) 3/0-500 kcmil CU (2) 4/0-500 kcmil AL
WB1600C	WB1600CU	600	OH/UG	LXD6	39.19	15.20	11.03	(2) 3/0-500 kcmil CU (2) 4/0-500 kcmil AL
WB1700C ^②	WB1700CU	700	OH/UG	MXD6	61.19	24.19	11.03	(3) 1/0-500 kcmil
WB1800C	WB1800CU	800	OH/UG	MXD6	61.19	24.19	11.03	(3) 1/0-500 kcmil
WB1900C ^②	WB1900CU	900	OH/UG	NXD6	61.19	24.19	11.03	(4) 1/0-500 kcmil
WB11000C	WB11000CU	1000	OH/UG	NXD6	61.19	24.19	11.03	(4) 1/0-500 kcmil
WB11200C	WB11200CU	1200	OH/UG	NXD6	61.19	24.19	11.03	(4) 1/0-500 kcmil
WB11400T ^{②④}	WB11400TU ^⑤	1400	OH	PXD6	72.06	31.34	14.66	3 Sets of 2 Studs  (lugs not included)
WB11400B ^{②④}	WB11400BU ^⑤		UG	PXD6	72.06	31.34	14.66	
WB11600T ^④	WB11600TU ^⑤	1600	OH	PXD6	72.06	31.34	14.66	
WB11600B ^④	WB11600BU ^⑤		UG	PXD6	72.06	31.34	14.66	
WB11800B ^{②④}	WB11800BU ^⑤	1800	UG	RXD6	72.06	31.34	14.66	
WB11800W	WB11800WU	1800	OH/UG	RXD6	72.06	50.56	14.66	
WB12000B ^④	WB12000BU ^⑤	2000	UG	RXD6	72.06	31.34	14.66	
WB12000W ^{②④}	WB12000WU ^⑤		OH/UG	RXD6	72.06	50.56	14.66	

① Dimensions shown are representative of outside box dimensions and do not include allowances for mounting bumps, endwalls, covers, hubs, or hardware protrusions. Dimensions are subject to change.

② Additional lead time required. Contact sales office for details. 100K and non-standard amperage modules.

③ Factory installed lugs standard on 200-1200A standard breaker main modules. Additional lug kit options available for 750 conductor size. Refer to pages 60-61 for lug kit options on 200-1200A standard main breakers. Field installable compression lug landing pad also available. Refer to page 71 for lug landing pad options. NEMA II Stud Pattern compression lugs must be installed by user or utility. Lugs NOT included on 1400A-2000A standard breaker main modules and must be ordered separately. Refer to pages 60-61 for lug size options.

④ 1200 amp maximum feed per side-must be used as a center fed main.

⑤ All breakers have a non-interchangeable trip unit.

Power Mod: Type WB Standard Circuit Breaker Mains

Factory installed lugs are standard on 200-1200A standard breaker main modules. Additional lug kit options are available for 750 conductor size. Refer to page 60-61 for lug kit options on 200-1200A standard main breakers. In addition, a field installable compression lug landing pad is also available. Refer to pages 60-61 & 71 for lug landing pad options. NEMA II Stud Pattern compression lugs must be installed by user or utility.

Lugs are NOT included on 1400A-2000A standard breaker main modules and must be ordered separately. Refer to pages 60-61 for lug size options.



Circuit Breaker Service Entrance Modules: 3-Phase, 4-Wire SN, 240V AC Max

Catalog Number (65k AIC) ^①	Catalog Number (100k AIC) ^{②③}	Ampere Rating	Service Feed	Breaker Type ^④	Dimensions (inches) ^①			Factory Installed Line Side Connections
					Height	Width	Depth	
WB3200C ^②	WB3200CU	200	OH/UG	JXD6	39.19	15.20	11.03	(2) 3/0-500 kcmil CU (2) 4/0-500 kcmil AL
WB3250C ^②	WB3250CU	250	OH/UG	JXD6	39.19	15.20	11.03	(2) 3/0-500 kcmil CU (2) 4/0-500 kcmil AL
WB3300C ^②	WB3300CU	300	OH/UG	JXD6	39.19	15.20	11.03	(2) 3/0-500 kcmil CU (2) 4/0-500 kcmil AL
WB3350C ^②	WB3350CU	350	OH/UG	JXD6	39.19	15.20	11.03	(2) 3/0-500 kcmil CU (2) 4/0-500 kcmil AL
WB3400C	WB3400CU	400	OH/UG	JXD6	39.19	15.20	11.03	(2) 3/0-500 kcmil CU (2) 4/0-500 kcmil AL
WB3450C ^②	WB3450CU	450	OH/UG	LXD6	39.19	15.20	11.03	(2) 3/0-500 kcmil CU (2) 4/0-500 kcmil AL
WB3500C ^②	WB3500CU	500	OH/UG	LXD6	39.19	15.20	11.03	(2) 3/0-500 kcmil CU (2) 4/0-500 kcmil AL
WB3600C	WB3600CU	600	OH/UG	LXD6	39.19	15.20	11.03	(2) 3/0-500 kcmil CU (2) 4/0-500 kcmil AL
WB3700C ^②	WB3700CU	700	OH/UG	MXD6	61.19	24.19	11.03	(3) 1/0-500 kcmil
WB3800C	WB3800CU	800	OH/UG	MXD6	61.19	24.19	11.03	(3) 1/0-500 kcmil
WB3900C ^②	WB3900CU	900	OH/UG	NXD6	61.19	24.19	11.03	(4) 1/0-500 kcmil
WB31000C	WB31000CU	1000	OH/UG	NXD6	61.19	24.19	11.03	(4) 1/0-500 kcmil
WB31200C	WB31200CU	1200	OH/UG	NXD6	61.19	24.19	11.03	(4) 1/0-500 kcmil
WB31400T ^{②④}	WB31400TU ^④	1400	OH	PXD6	72.06	31.34	14.66	3 Sets of 2 Studs  (lugs not included)
WB31400B ^{②④}	WB31400BU ^④		UG	PXD6	72.06	31.34	14.66	
WB31600T ^④	WB31600TU ^④	1600	OH	PXD6	72.06	31.34	14.66	
WB31600B ^④	WB31600BU ^④		UG	PXD6	72.06	31.34	14.66	
WB31800B ^{②④}	WB31800BU ^④	1800	UG	RXD6	72.06	31.34	14.66	
WB31800W	WB31800WU	1800	OH/UG	RXD6	72.06	50.56	14.66	
WB32000B ^{②④}	WB32000BU ^④	2000	UG	RXD6	72.06	31.34	14.66	
WB32000W ^{②④}	WB32000WU ^④		OH/UG	RXD6	72.06	50.56	14.66	

① Dimensions shown are representative of outside box dimensions and do not include allowances for mounting bumps, endwalls, covers, hubs, or hardware protrusions. Dimensions are subject to change.

② Additional lead time required. Contact sales office for details. 100K and non-standard amperage modules.

③ Factory installed lugs standard on 200-1200A standard breaker main modules. Additional lug kit options available for 750 conductor size. Refer to pages 60-61 for lug kit options on 200-1200A standard main breakers. Field installable compression lug landing pad also available. Refer to page 71 for lug landing pad options. NEMA II Stud Pattern compression lugs must be installed by user or utility. Lugs NOT included on 1400A-2000A standard breaker main modules and must be ordered separately. Refer to pages 60-61 for lug size options.

④ 1200 amp maximum feed per side-must be used as a center fed main.

⑤ All breakers have a non-interchangeable trip unit.

Power Mod Circuit Breaker - Pullbox Combinations

EUSERC - compliant breaker - pullbox combination modules (type WEB) offer EUSERC compatibility, a wider range of lug options, and extra space for pulling in conductors.

Features include:

- QuickSystem™ features
- Factory installed NEMA II studs
- 750 kcmil AL wire options
- 65K AIC standard, 100K AIC available for all models
- Removable blank bottom endwall
- Externally accessible breaker handle with padlock capability
- Field installable shunt trips
- Large removable ground wire trough with generous space for grounding conductors

Circuit Breaker-Pullbox Combinations Quick Reference

- 200-1200A
- 1200A thru-bus
- UL standard # UL67
- UL file # E27100
- AIC rating (65k & 100k)
- Voltage
 - Single phase 120/240V AC Max
 - Three phase 240V AC Max
- All swing latches and rivets are stainless steel
- NEMA 3R rated
- G90 galvanized steel
- ANSI 61 paint
- EUSERC drawing number 347
- Custom options available! Details on p. 72



Power Mod: Type WEB Circuit Breaker - Pullbox Combinations

Lugs are NOT included on 1400A-2000A standard breaker main modules and must be ordered separately. Refer to pages 60-61 for lug size options.



Combination Circuit Breaker and Pullbox Modules: 1-Phase, 3-Wire SN, 120/240V AC Max, Meets EUSERC Requirements

Catalog Number (65k AIC)	Catalog number (100k AIC) ^②	Ampere Rating	Service Feed	Breaker Type ^④	Dimensions (inches) ^①			Line Side ^③ Connections (lugs not included)
					Height	Width	Depth	
WEB1200B ^②	WEB1200BU	200	UG	JXD6	54.88	28.28	13.06	1 set of 2 studs 
WEB1250B ^②	WEB1250BU	250	UG	JXD6	54.88	28.28	13.06	
WEB1300B ^②	WEB1300BU	300	UG	JXD6	54.88	28.28	13.06	
WEB1350B ^②	WEB1350BU	350	UG	JXD6	54.88	28.28	13.06	
WEB1400B	WEB1400BU	400	UG	JXD6	54.88	28.28	13.06	
WEB1500B ^②	WEB1500BU	500	UG	LXD6	54.88	28.88	13.06	2 sets of 2 studs 
WEB1600B	WEB1600BU	600	UG	LXD6	54.88	28.28	13.06	
WEB1700B ^②	WEB1700BU	700	UG	MXD6	59.34	34.22	12.47	
WEB1800B	WEB1800BU	800	UG	MXD6	59.34	34.22	12.47	3 sets of 2 studs 
WEB1900B ^②	WEB1900BU	900	UG	NXD6	59.34	34.22	12.47	
WEB11000B	WEB11000BU	1000	UG	NXD6	59.34	34.22	12.47	
WEB11200B	WEB11200BU	1200	UG	NXD6	59.34	34.22	12.47	

- ① Dimensions shown are representative of outside box dimensions and do not include allowances for mounting bumps, endwalls, covers, hubs, or hardware protrusions. Dimensions are subject to change.
- ② Additional lead time required. Contact sales office for details. Non-standard modules
- ③ Lugs not included. Refer to page 60-61 for lug size options. 750 conductor size available. NEMA II stud pattern compression lugs must be installed by user or utility.
- ④ All breakers have a non-interchangeable trip unit.

Power Mod: Type WEB Circuit Breaker - Pullbox Combinations

Lugs are NOT included on 1400A-2000A standard breaker main modules and must be ordered separately. Refer to pages 60-61 for lug size options.



Combination Circuit Breaker and Pullbox Modules: 3-Phase, 4-Wire SN, 240V AC Max, Meets EUSERC Requirements

Catalog Number (65k AIC)	Catalog Number (100k AIC) ^②	Ampere Rating	Service Feed	Breaker Type ^④	Dimensions (inches) ^①			Line Side ^③ Connections (lugs not included)
					Height	Width	Depth	
WEB3200B ^②	WEB3200BU	200	UG	JXD6	54.88	28.28	13.06	1 set of 2 studs 
WEB3250B ^②	WEB3250BU	250	UG	JXD6	54.88	28.28	13.06	
WEB3300B ^②	WEB3300BU	300	UG	JXD6	54.88	28.28	13.06	
WEB3350B ^②	WEB3350BU	350	UG	JXD6	54.88	28.28	13.06	
WEB3400B	WEB3400BU	400	UG	JXD6	54.88	28.28	13.06	
WEB3500B ^②	WEB3500BU	500	UG	LXD6	54.88	28.28	13.06	2 sets of 2 studs 
WEB3600B	WEB3600BU	600	UG	LXD6	54.88	28.28	13.06	
WEB3700B ^②	WEB3700BU	700	UG	MXD6	59.34	34.22	12.47	
WEB3800B	WEB3800BU	800	UG	MXD6	59.34	34.22	12.47	3 sets of 2 studs 
WEB3900B ^②	WEB3900BU	900	UG	NXD6	59.34	34.22	12.47	
WEB31000B	WEB31000BU	1000	UG	NXD6	59.34	34.22	12.47	
WEB31200B	WEB31200BU	1200	UG	NXD6	59.34	34.22	12.47	

① Dimensions shown are representative of outside box dimensions and do not include allowances for mounting bumps, endwalls, covers, hubs, or hardware protrusions. Dimensions are subject to change.

② Additional lead time required. Contact sales office for details. Non-standard modules

③ Lugs not included. Refer to page 60-61 for lug size options. 750 conductor size available. NEMA II stud pattern compression lugs must be installed by user or utility.

④ All breakers have a non-interchangeable trip unit.

Power Mod Cross Bus Main Modules

Cross Bus Main modules (type WXB) offer two distinct functions: first they can be used to connect Siemens Sentron Busway to a Power Mod line-up. Second they can be utilized to offer lower service disconnect ampacities or unique configurations where an incoming tapbox is preferred. See application pages for examples.

Features include:

- QuickSystem™ features
- Incoming & outgoing bus connections (right to left or left to right)
- Standardized connection points to Siemens Sentron Busway
- 65K AIC standard, 100K AIC available for all models
- Externally accessible breaker handle with padlock capability
- Broad ampacity ratings up to 1200 Amps with non-standard amperages available (such as 700, 900, etc.)
- Field installable shunt trips

Cross Bus Mains Quick Reference

- 200-1200A
- 1200A thru-bus rating
- UL Standard # UL67
- UL file # E27100
- AIC rating (65k & 100k)
- Voltage:
 - Single phase 120/240V AC max
 - Three phase 240V AC max
- All swing latches and rivets are stainless steel
- NEMA 3R rated
- G90 galvanized steel
- ANSI 61 paint
- Custom options available! Details on p. 72



Power Mod: Type WXB Main Units

Connects via thru bussing only - NO LUGS and NOT SERVICE ENTRANCE RATED



1-Phase, 3-Wire SN, 120/240V AC^②

Catalog Number (65k AIC)	Catalog Number (100k AIC) ^③	Ampere Rating	Service Feed	Breaker Type	Dimensions ^①		
					Height	Width	Depth
WXB1200N ^③	WXB1200NU	200	Thru Bus	JXD6	27.05	15.59	10.82
WXB1250N ^③	WXB1250NU	250	Thru Bus	JXD6	27.05	15.59	10.82
WXB1300N ^③	WXB1300NU	300	Thru Bus	JXD6	27.05	15.59	10.82
WXB1350N ^③	WXB1350NU	350	Thru Bus	JXD6	27.05	15.59	10.82
WXB1400N	WXB1400NU	400	Thru Bus	JXD6	27.05	15.59	10.82
WXB1450N ^③	WXB1450NU	450	Thru Bus	LXD6	27.05	15.59	10.82
WXB1500N ^③	WXB1500NU	500	Thru Bus	LXD6	27.05	15.59	10.82
WXB1600N	WXB1600NU	600	Thru Bus	LXD6	27.05	15.59	10.82
WXB1700N ^③	WXB1700NU	700	Thru Bus	MXD6	36.05	18.13	12.63
WXB1800N	WXB1800NU	800	Thru Bus	MXD6	36.05	18.13	12.63
WXB1900N ^③	WXB1900NU	900	Thru Bus	NXD6	36.05	18.13	12.63
WXB11000N	WXB11000NU	1000	Thru Bus	NXD6	36.05	18.13	12.63
WXB11200N	WXB11200NU	1200	Thru Bus	NXD6	36.05	18.13	12.63

3-Phase, 4-Wire SN, 240V AC Max^②

Catalog Number (65k AIC)	Catalog Number (100k AIC) ^③	Ampere Rating	Service Feed	Breaker Type	Dimensions ^①		
					Height	Width	Depth
WXB3200N ^③	WXB3200NU	200	Thru Bus	JXD6	27.05	15.59	10.82
WXB3250N ^③	WXB3250NU	250	Thru Bus	JXD6	27.05	15.59	10.82
WXB3300N ^③	WXB3300NU	300	Thru Bus	JXD6	27.05	15.59	10.82
WXB3350N ^③	WXB3350NU	350	Thru Bus	JXD6	27.05	15.59	10.82
WXB3400N	WXB3400NU	400	Thru Bus	JXD6	27.05	15.59	10.82
WXB3450N ^③	WXB3450NU	450	Thru Bus	LXD6	27.05	15.59	10.82
WXB3500N ^③	WXB3500NU	500	Thru Bus	LXD6	27.05	15.59	10.82
WXB3600N	WXB3600NU	600	Thru Bus	LXD6	27.05	15.59	10.82
WXB3700N ^③	WXB3700NU	700	Thru Bus	MXD6	36.05	18.13	12.63
WXB3800N	WXB3800NU	800	Thru Bus	MXD6	36.05	18.13	12.63
WXB3900N ^③	WXB3900NU	900	Thru Bus	NXD6	36.05	18.13	12.63
WXB31000N	WXB31000NU	1000	Thru Bus	NXD6	36.05	18.13	12.63
WXB31200N	WXB31200NU	1200	Thru Bus	NXD6	36.05	18.13	12.63

^① Dimensions shown are representative of outside box dimensions and do not include allowances for mounting bumps, endwalls, covers, hubs, or hardware protrusions. Dimensions are subject to change.

^② Connects via thru bussing only - NO LUGS and NOT SERVICE ENTRANCE RATED

^③ Non Standard item - extended lead time applies

Power Mod Feed Thru Main Modules

WBT - Feed Thru Mains

Feed thru mains (type WBT) offer the ability to pull conductors in and out of the enclosure for rise cable or loop feed applications as well as a main breaker device utilizing an incoming and out-going thru bus connections (including incoming lugs). This patented design allows the user to utilize the WBT family to connect to Siemens Sentron Busway. In addition users don't have to utilize any additional tap boxes as lugs are already included in the units. This can save the end-user on the material cost of the meter bank. Please see the applications pages for more information.

Features include:

- QuickSystem™ features
- Incoming & Outgoing Power Mod thru bus
- Standard compression lug capability
- 65K AIC standard, 100K AIC available for all models
- Broad ampacity ratings up to 1200 Amps with non-standard amperages available (such as 700, 900, etc...)
- Field installable shunt trip

Feed Thru Mains Quick Reference

- 200-1200A (breaker)
- 400-2400A (feed thru)
- 1200 thru-bus rating
- UL Standard #67
- UL file #E27100
- AIC rating (65K & 100K)
- Voltage:
 - Three Phase 240V AC max
- All swing latches and rivets are stainless steel
- NEMA 3R (outdoor)
- G90 galvanized steel
- ANSI 61 paint
- Custom options available! Details on p. 72

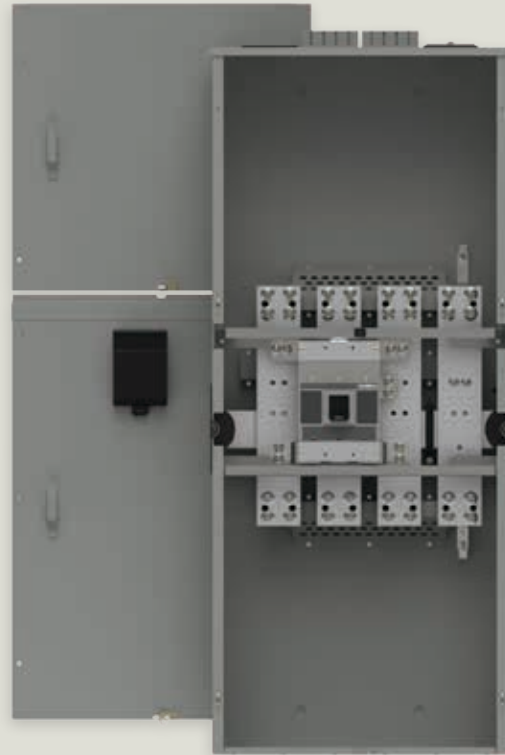

Power Mod: Type WBT Feed Thru Main Units

- Connects via lugs and service entrance rated.
- Lug kits not included. (2) Lug kits must be ordered separately per module.



Type WBT Feed Thru Main Units

Catalog Number (65KAIC)	Catalog Number (100KAIC)	Catalog Number (65KAIC) Blank end Wall	Catalog Number (100KAIC) Blank end Wall	Breaker Amperage Rating	Feed Through Bus Rating	Breaker Type	Dimensions (inches) ^①		
							Height	Width	Depth

3-phase, 4-wire SN, 240V AC Max.

WBT31200X200	WBT31200X200U	WBT312X200NH	WBT312X200UNH	200	1200	JXD6	66.21	27.59	13.30
WBT31200X250	WBT31200X250U	WBT312X250NH	WBT312X250UNH	250	1200	JXD6	66.21	27.59	13.30
WBT31200X300	WBT31200X300U	WBT312X300NH	WBT312X300UNH	300	1200	JXD6	66.21	27.59	13.30
WBT31200X350	WBT31200X350U	WBT312X350NH	WBT312X350UNH	350	1200	JXD6	66.21	27.59	13.30
WBT31200X400	WBT31200X400U	WBT312X400NH	WBT312X400UNH	400	1200	JXD6	66.21	27.59	13.30
WBT31200X450	WBT31200X450U	WBT312X450NH	WBT312X450UNH	450	1200	JXD6	66.21	27.59	13.30
WBT31200X500	WBT31200X500U	WBT312X500NH	WBT312X500UNH	500	1200	LDX6	66.21	27.59	13.30
WBT31200X600	WBT31200X600U	WBT312X600NH	WBT312X600UNH	600	1200	LDX6	66.21	27.59	13.30
WBT32400X700	WBT32400X700U	WBT324X700NH	WBT324X700UNH	700	2400	MXD6	79.75	35.55	16.96
WBT32400X800	WBT32400X800U	WBT324X800NH	WBT324X800UNH	800	2400	MXD6	79.75	35.55	16.96
WBT32400X900	WBT32400X900U	WBT324X900NH	WBT324X900UNH	900	2400	NXD6	79.75	35.55	16.96
WBT32400X1000	WBT32400X1000U	WBT324X1000NH	WBT324X1000UNH	1000	2400	NXD6	79.75	35.55	16.96
WBT32400X1200	WBT32400X1200U	WBT324X1200NH	WBT324X1200UNH	1200	2400	NXD6	79.75	35.55	16.96

① Dimensions subject to changes.

Power Mod Standard Switch Mains

Standard switch modules (type WS) are designed for flexibility, space savings, & durability.

Features include:

- QuickSystem™ features
- Standard compression lug capability
- Invertibility: 400-800 Amp devices can be rotated to accommodate the desired incoming feed direction
- 750 kcmil AL wire options for most models
- 100K AIC standard for all models
- Class T fuse provisions
- Front mounted handle - removes the need for spacers on the side
- Broad ampacity ratings up to 1200 Amps

Standard Switch Mains Quick Reference

- 200-1200A
- 1200A thru-bus
- UL Standard # UL98
- UL file #E25506
- AIC rating (100k AIC)
- Voltage:
 - Single phase 120/240V AC max
 - Three phase 240V AC max
- All swing latches and rivets are stainless steel
- NEMA 3R rated
- G90 galvanized steel
- ANSI 61 paint
- Custom options available! Details on p. 72



Power Mod: Type WS Standard Switch Mains

Lugs not included on most models. NEMA II stud pattern lugs must be installed by user or utility. Refer to pages 60-61 for lug size options.



Fusible Switch Service Entrance Modules: 1-Phase, 3-Wire SN, 120/240V AC^①

Catalog Number (100k AIC)	Rating Amps	Service Feed	Fuse Type ^②	Dimensions (inches) ^①			Line Side Connections
				Height	Width	Depth	
WMP02U ^③	200	OH/UG	T	33.00	12.00	13.00	(1) #6 - 250 KCMIL
WS1400CU ^③	400	OH/UG ^④	T	50.13	15.19	16.31	1 set of 2 studs  (lugs not included)
WS1600CU ^③	600	OH/UG ^④	T	50.13	15.19	16.31	
WS1800CU ^③	800	OH/UG ^④	T	50.13	15.19	16.31	2 sets of 2 studs  (lugs not included)
WS11200BU ^{⑤⑦}	1200	UG	T	50.06	20.22	16.06	(4) 250- 500 kcmil

Fusible Switch Service Entrance Modules: 3-Phase, 4-Wire WN, 240V AC Max^①

Catalog Number (100k AIC)	Rating Amps	Service Feed	Fuse Type ^②	Dimensions (inches) ^①			Line Side Connections
				Height	Width	Depth	
WMP024U ^③	200	OH/UG	T	33.00	12.00	13.00	(1) #6 - 250 KCMIL
WS3400CU ^③	400	OH/UG ^④	T	50.13	15.19	16.31	1 set of 2 studs  (lugs not included)
WS3600CU ^③	600	OH/UG ^④	T	50.13	15.19	16.31	
WS3800CU ^③	800	OH/UG ^④	T	50.13	15.19	16.31	2 sets of 2 studs  (lugs not included)
WS31200BU ^{⑤⑦}	1200	UG	T	50.06	20.22	16.06	(4) 250-500 kcmil

^① Dimensions shown are representative of outside box dimensions and do not include allowances for mounting bumps, endwalls, covers, hubs, or hardware protrusions. Dimensions are subject to change.

^② Additional lead time required. Contact sales office for details. Fusible pull-out switch. No QuickSystem features offered for this catalog number.

^③ Lugs not included. Refer to page 60-61 for lug size options. NEMA II stud pattern compression lugs must be installed by user or utility.

^④ Module is invertible - rotate device to point hub openings to appropriate feed direction.

^⑤ 500 kcmil max wire range size.

^⑥ Fuses not included.

^⑦ Device uses a molded case switch (looks like a breaker). Class T fuses must be installed in conjunction with the molded case switch for proper operation.

Power Mod Switch-Pullbox Combinations

EUSERC - compliant switch-pullbox combination modules (type WES) offer EUSERC compatibility, a wider range of lug options, and extra space for pulling in conductors.

Features include:

- QuickSystem™ features
- Factory installed NEMA II studs
- Broad ampacity ratings up to 1200 Amps
- 750kcmil AL wire options
- 100K AIC standard for all models
- Removable blank bottom endwall
- Front mounted handle - removes the need for spacers on the side
- Class T fuse provisions
- Large removable ground wire trough with generous space for grounding conductors
- Extra ground lugs in each device

Switch-Pullbox Combinations Quick Reference

- 400-1200A
- 1200A thru-bus
- UL standard # UL98
- UL file # E25506
- AIC Rating (100k AIC)
- Voltage:
 - Single phase 120/240V AC max
 - Three phase 240V AC max
- All swing latches and rivets are stainless steel.
- NEMA 3R rated
- G90 galvanized steel
- ANSI 61 paint
- EUSERC drawing number 347
- Custom options available! Details on p. 72



Power Mod: Type WES Switch-Pullbox Combinations

Lugs not included. NEMA II Stud Pattern lugs must be installed by user or utility. Refer to pages 60-61 for lug size options.



Combination Fusible Switch and Pullbox Modules: 1-Phase, 3-Wire SN, 120/240V AC Meets EUSERC Requirements^③

Catalog Number (100k AIC)	Rating Amps	Service Feed	Fuse Type ^②	Dimensions (inches) ^①			Line Side ^② Connections (lugs not included)
				Height	Width	Depth	
WES1400BU	400	UG	T	54.06	29.19	15.94	1 set of 2 studs 
WES1600BU	600	UG	T	54.06	29.19	15.94	2 sets of 2 studs 
WES1800BU	800	UG	T	54.06	29.19	15.94	
WES11200BU ^④	1200	UG	T	68.97	34.25	13.47	3 sets of 2 studs 

Combination Fusible Switch and Pullbox Modules: 3-Phase, 4-Wire SN, 240V AC Max Meets EUSERC Requirements^③

Catalog Number (100k AIC)	Rating Amps	Service Feed	Fuse Type	Dimensions (inches) ^①			Line Side ^② Connections (lugs not included)
				Height	Width	Depth	
WES3400BU	400	UG	T	54.06	29.19	15.94	1 set of 2 studs 
WES3600BU	600	UG	T	54.06	29.19	15.94	2 sets of 2 studs 
WES3800BU	800	UG	T	54.06	29.19	15.94	
WES31200BU ^④	1200	UG	T	68.97	34.25	13.47	3 sets of 2 studs 

^① Dimensions shown are representative of outside box dimensions and do not include allowances for mounting bumps, endwalls, covers, hubs, or hardware protrusions. Dimensions are subject to change.

^② Lugs not included. Refer to page 60-61 for lug size options. NEMA II stud pattern compression lugs must be installed by user or utility.

^③ Fuses not included.

^④ Device uses a molded case switch (looks like a breaker). Class T fuses must be installed in conjunction with the molded case switch for proper operation.

Power Mod Standard Tapboxes

Standard tapbox modules (type WTB) are designed for versatility, space savings, and flexibility.

Features include:

- QuickSystem™ features
- Standard compression lug capability
- Invertibility: devices can be rotated to accommodate the desired incoming feed direction
- 750 kcmil AL wire options for most models
- 100K AIC standard for all models
- Broad ampacity ratings from 400 to 2400 Amps
- Line and load capability- service entrance and sub feed rated

Standard Tapbox Quick Reference

- 400-2400A
- 1200A thru-bus rating
- UL Standard # UL67
- UL file # E27100
- AIC rating (100K AIC)
- Voltage
 - Single phase 120/240V AC max
 - Three phase 240V AC max
- All swing latches and rivets are stainless steel.
- NEMA 3R rated
- G90 galvanized steel
- ANSI 61 paint
- Custom options available! Details on p. 72



Restrictions for 1600-2400 Amp Type WTB Power Mod Tap Boxes:



When the 1600, 2000, or 2400 Amp tap boxes are used as service entrance equipment (fed directly from utility transformer) or when the supply originates from a Class L fuse or Siemens WL circuit breaker there are restrictions on the use of an additional down-stream (thru-bus connected) WTB, WTB, WET, or WT type Power Mod tap boxes. In these instances a type "WXB" module must be used as protection for the downstream tap box. (placed between the incoming WTB tap box and the downstream outgoing tap box). See page 18 for an example. This restriction does **NOT** apply if the tap box is fed from a Siemens Sentron or VL series molded case circuit breaker. Note that the maximum amperage for a Siemens Sentron circuit breaker is 2,000 Amps.

Power Mod: Type WTB Standard Tapboxes









⚠ Restrictions for 1600-2400 Amp Type WTB Power Mod Tap Boxes: ⚠

When the 1600, 2000, or 2400 Amp tap boxes are used as service entrance equipment (fed directly from utility transformer) or when the supply originates from a Class L fuse or Siemens WL circuit breaker there are restrictions on the use of an additional down-stream (thru-bus connected) WTB, WTB, WET, or WT type Power Mod tap boxes. In these instances a type "WXB" module must be used as protection for the downstream tap box. (placed between the incoming WTB tap box and the downstream outgoing tap box). See page 18 for an example. This restriction does **NOT** apply if the tap box is fed from a Siemens Sentron or VL series molded case circuit breaker. Note that the maximum amperage for a Siemens Sentron circuit breaker is 2,000 Amps.

Lugs not included. Refer to pages 60-61 for lug size options. NEMA II Stud Pattern lugs must be installed by user or utility.



Tap Box Modules: 1-Phase, 3-Wire WN, 120/240V AC^③

Catalog Number (100k AIC)	Ampere Rating	Service Feed ^④	Dimensions (inches) ^①			Line Side Connections ^② (lugs not included)
			Height	Width	Depth	
WTB1400CU	400	OH/UG	40.13	12.22	13.19	1 set of 2 studs 
WTB1800CU	800	OH/UG	40.13	12.22	13.19	2 sets of 2 studs 
WTB11200CU	1200	OH/UG	47.13	15.61	13.31	3 sets of 2 studs 
WTB11600CU ^{⑤⑥}	1600	OH/UG	49.09	25.09	13.81	3 sets of 2 studs 
WTB12000TU ^⑦	2000	OH	67.94	35.00	14.78	3 sets of 2 studs 
WTB12000BU ^⑧		UG				Optional 4 sets of 2 studs ^{②⑧} 
WTB12400TU ^⑦	2400	OH	67.94	35.00	14.78	3 sets of 2 studs 
WTB12400BU ^⑧		UG				Optional 4 sets of 2 studs ^{②⑧} 

Tap Box Modules: 3-Phase, 4-Wire SN, 240V AC Max^③

Catalog Number (100k AIC)	Ampere Rating	Service Feed ^④	Dimensions (inches) ^①			Line Side Connections ^② (lugs not included)
			Height	Width	Depth	
WTB3400CU	400	OH/UG	40.13	12.22	13.19	1 set of 2 studs
WTB3800CU	800	OH/UG	40.13	12.22	13.19	2 sets of 2 studs
WTB31200CU	1200	OH/UG	60.31	15.61	17.75	
WTB31600CU ^{⑤⑥}	1600	OH/UG	49.09	25.09	13.81	3 sets of 2 studs
WTB32000TU ^⑦	2000	OH	67.94	35.00	14.78	3 sets of 2 studs
WTB32000BU ^⑧		UG				3 sets of 2 studs
WTB32400TU ^⑦	2400	OH	67.94	35.00	14.78	3 sets of 2 studs
WTB32400BU ^⑧		UG				Optional 4 sets of 2 studs ^{②⑧}

① Dimensions shown are representative of outside box dimensions and do not include allowances for mounting bumps, endwalls, covers, hubs, or hardware protrusions. Dimensions are subject to change.

② Lugs not included. Refer to page 60-61 for lug size options. 750 conductor size available NEMA II stud pattern compression lugs must be installed by user or utility.

③ 1200 amp maximum feed per side-must be used as a center fed main.

④ Module is invertible- rotate device to point hub openings to appropriate feed direction.

⑤ QuickConnect not included. If used for load side application an additional coupler must be ordered.

⑥ Please see restriction note above.

⑦ Please see lug kit number LK18500N2C on p.61. For use with 500kcmil ONLY!

⑧ Fits 2400amp models ONLY!

Power Mod Tapbox - Pullbox Combinations

EUSERC - compliant Tapbox - Pullbox Combination modules (type WET) offer EUSERC compatibility, a wider range of lug options, and extra space for pulling in conductors.

Features include:

- QuickSystem™ features
- Standard compression lug capability
- 750 kcmil AL wire options for most models
- 100K AIC standard for all models
- Broad ampacity ratings from 400 to 1200 Amps
- Removable bottom endwall

Tapbox- Pullbox Combination Quick Reference

- 400-1200A
- 1200 Amp thru-bus rating
- UL Standard #'s UL67
- UL file # E27100
- AIC Rating (100k)
- Voltage
 - Single phase 120/240V AC max
 - Three phase 240V AC max
- All swing latches and rivets are stainless steel.
- NEMA 3R rated
- G90 galvanized steel
- ANSI 61 paint
- EUSERC drawing number 315
- Custom options available! Details on p. 72



Power Mod: Type WET Tapbox - Pullbox Combinations

Lugs not included. Refer to page 60-61 for lug size options. NEMA II Stud Pattern lugs must be installed by user or utility.



EUSERC Tap Box Modules: 1-Phase, 3-Wire SN, incoming, 120/240V AC^① Meets EUSERC Requirements

Catalog Number (100k AIC) ^②	Ampere Rating	Service Feed ^③	Dimensions (inches) ^①			Line Side Connections ^② (lugs not included)
			Height	Width	Depth	
WET1400BU	400	UG	46.19	17.63	8.56	1 set of 2 studs 
WET1800BU	800	UG	50.19	27.13	11.38	2 sets of 2 studs 
WET11200BU	1200	UG	50.19	35.19	11.38	3 sets of 2 studs 

EUSERC Tap Box Modules: 3-Phase, 4-Wire SN, incoming, 240V AC Max^① Meets EUSERC Requirements

Catalog Number (100k AIC) ^②	Ampere Rating	Service Feed	Dimensions (inches) ^①			Line Side Connections ^② (lugs not included)
			Height	Width	Depth	
WET3400BU	400	UG	46.19	17.63	8.56	1 set of 2 studs 
WET3800BU	800	UG	50.19	27.13	11.38	2 sets of 2 studs 
WET31200BU	1200	UG	50.19	35.19	11.38	3 sets of 2 studs 

① Dimensions shown are representative of outside box dimensions and do not include allowances for mounting bumps, endwalls, covers, hubs, or hardware protrusions. Dimensions are subject to change.

② Lugs not included. Refer to page 60-61 for lug size options. NEMA II stud pattern compression lugs must be installed by user or utility.

③ QuickConnect not included. Service entrance rated only.

Power Mod Feed Thru Tapbox

Family (type WT), the Feed Thru Tapbox features cable in cable out lugs. Valuable for use in mid rise and high rise projects.

Features include:

- QuickSystem features
- Standard compression lug capability
- 250kcmil Al wire options
- 100k AIC standard
- Removable bottom endwall

Feed Thru Tapbox Quick Reference

- 400 - 2400A
- 1200A thru bus
- UL standard 67
- UL file no. E27100
- AIC rating (100k AIC)
- Voltage:
 - Single phase 120/240V AC max.
 - Three phase, 240V AC max
- All swing latches and rivets are stainless steel.
- NEMA 3R rated
- G90 stainless steel
- ANSI 61 paint
- Custom options available! Details on p. 72
- Broad ampacity ratings from 400 to 2400 Amps
- Not Service entrance rated



Restrictions for 1600-2400 Amp Type WT Power Mod Pull-Thru Tap Boxes:



When the 1600, 2000, or 2400 Amp tap boxes are used as service entrance equipment (fed directly from utility transformer) or when the supply originates from a Class L fuse there are restrictions on the use of an additional down-stream (thru-bus connected) WTBN, WTB, WET, or WT type Power Mod tap boxes. In these instances a type "WXB" module must be used as protection for the downstream tap box (placed between the incoming WT tap box and the downstream outgoing tap box). See page 19 for an example. This restriction does **NOT** apply if the tap box is fed from a Siemens Sentron or VL series molded case circuit breaker. Note that the maximum amperage for a Siemens Sentron circuit breaker is 2,000 Amps.

Please note that Siemens type WL circuit breakers can NOT be used to feed WT Power Mod tap boxes.

Power Mod: Type WT Feed Thru Tapbox





⚠ Restrictions for 1600-2400 Amp Type WT Power Mod Pull-Thru Tap Boxes: ⚠

When the 1600, 2000, or 2400amp tap boxes are used as service entrance equipment (fed directly from utility transformer) or when the supply originates from a Class L fuse there are restrictions on the use of an additional downstream (thru-bus connected) WTBN, WTB, WET, or WT type Power Mod tap boxes. In these instances a type "WXB" module must be used as protection for the downstream tap box (placed between the incoming WT tap box and the downstream outgoing tap box). See page 19 for an example. This restriction does **NOT** apply if the tap box is fed from a Siemens Sentron or VL series molded case circuit breaker. Note that the maximum amperage for a Siemens Sentron circuit breaker is 2,000Amps. **Please note that Siemens type WL circuit breakers can NOT be used to feed WT Power Mod tap boxes.**

Lug kits not included.
(2) Lug kits must be ordered separately per module. Refer to page 60-61 in S&A Guide.



Feed Thru Tapbox Modules: 1-Phase, 120/240V AC^①

Catalog Number (100k AIC)	Ampere Rating	Service Feed	Dimensions (inches) ^①			Line Side Connections ^②
			Height	Width	Depth	
WT1400PU	400	OH/UG	59.25	17.25	8.13	1 set of 2 studs 
WT1800PU	800		62.25	26.75	11.13	2 sets of 2 studs 
WT11200PU	1200		68.34	35.19	11.41	3 sets of 2 studs 
WT11600PU ^③	1600		67.94	35	14.78	
WT12000PU ^③	2000					
WT12400PU ^{③④}	2400		3 sets of 2 studs 			
		Optional 4 sets of 2 studs ^⑤ 				

Feed Thru Tapbox Modules: 3-Phase, 240V AC^①

Catalog Number (100k AIC)	Ampere Rating	Service Feed	Dimensions (inches) ^①			Line Side Connections ^②
			Height	Width	Depth	
WT3400PU	400	OH/UG	59.25	17.25	8.13	1 set of 2 studs 
WT3800PU	800		62.25	26.75	11.13	2 sets of 2 studs 
WT31200PU	1200		68.34	35.19	11.41	3 sets of 2 studs 
WT31600PU ^③	1600		67.94	35	14.78	
WT32000PU ^③	2000					
WT32400PU ^③	2400		3 sets of 2 studs 			
		Optional 4 sets of 2 studs ^⑤ 				

- ① Dimensions shown are representative of outside box dimensions and do not include allowances for mounting bumps, endwalls, covers, hubs, or hardware protrusions. Dimensions are subject to change.
- ② Lugs not included. Refer to page 60-61 for lug size options. (2) Lug kits must be ordered separately per module. Refer to page 60-61 for lug size options.
- ③ 1200 amp maximum feed per side-must be used as a center fed main.
- ④ QuickConnect not included. If used for load side application an additional coupler must be ordered.
- ⑤ Please see restriction note above.
- ⑥ Please see lug kit number LK18500N2C on p.61. For use with 500kcmil ONLY!
- ⑦ Fits 2400amp models ONLY!

Power Mod Residential Meter Stacks

Power Mod's core offering of Residential Meter Stacks, type WMM, offers the widest product offering and flexibility in the industry. Each meter stack houses the QuickSystem™ features to maximize productivity and minimize labor costs. To aid in productivity and labor cost reductions our 225 Amp meter stacks feature a new breaker - the "QS". The QS breaker adds to the Siemens exclusive feature set on our new 225 Amp Residential Meter Stacks.

Benefits of the "QS" include:

- An exclusive 6 high 225 Amp meter stack at the same height as our 125 Amp meter stack - 225 to 125 conversion: No conversion kit needed.
- Single right hand bend wiring - saves time and wire
- 100K AIC offered from 100 up to 225 Amps

Siemens Residential Meter Stacks are packed with features inside and out: our exclusive knock out plate offers flexibility when pulling wires to the stack, new breaker supports keep breakers level and straight, moveable neutrals and grounds to save wire, and all of the QuickSystem features all designed with the contractor in mind.

Residential Meter Stacks Quick Reference

- 2-6 gang
- 125/225 Amp per position
- 1200 Amp thru-bus rating
- UL standard 67
- UL file no. E27100
- AIC rating (65k & 100k)
- Voltage:
 - Single phase 120/240V AC max.
 - Three phase in single phase out
 - 120/208V AC max.
 - 240/120V AC max.
- All swing latches and rivets are stainless steel.
- Outdoor= NEMA 3R rated
- Indoor= NEMA 1R rated
- G90 galvanized steel
- ANSI 61 paint
- Custom options available! Details on p. 72



Power Mod: Type WMM Residential Meter Stacks

1 phase 4J

- 2-6 gang
- 125/225 Amp per position
- 1200 Amp thru-bus rating

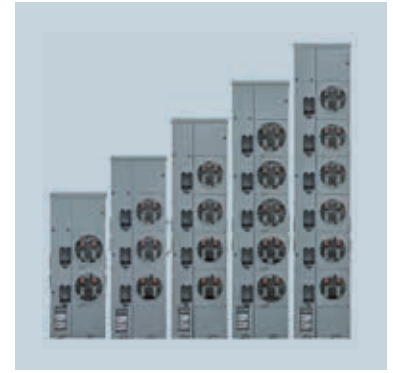

Residential 4-Jaw Ring Type Meter Stacks: 1-Phase, 3-Wire SN, Incoming and Outgoing^{③④}

Outdoor Catalog Number	Indoor Catalog Number	Meter Positions Per Stack	Breaker Provision	Maximum AIC ^⑤	Dimensions (inches) ^⑥		
					Height	Width	Depth
Max. tenant breaker (Amps): 125							
WMM21125	MM21125	2 Position	QP, QPH, HQP, MP-T, MP-HT, MP-MT	65k	34.31	13.09	8.09
WMM31125	MM31125	3 Position		65k	43.31	13.09	8.09
WMM41125	MM41125	4 Position		65k	52.31	13.09	8.09
WMM51125	MM51125	5 Position		65k	61.31	13.09	8.09
WMM61125	MM61125	6 Position		65k	70.31	13.09	8.09
Max. tenant breaker (Amps): 225 ^{②⑥}							
WMM21225	MM21225	2 Position	QS, QSH, QSHH, HQS, HQSH, QP, QPH, HQP, MP-T, MP-HT, MP-MT	100k	34.31	16.22	8.09
WMM31225	MM31225	3 Position		100k	43.31	16.22	8.09
WMM41225	MM41225	4 Position		100k	52.31	16.22	8.09
WMM51225	MM51225	5 Position		100k	61.31	16.22	8.09
WMM61225	MM61225	6 Position		100k	70.31	16.22	8.09

Residential 4-Jaw Ringless Type Meter Stacks: 1-Phase, 3-Wire SN, Incoming and Outgoing^{③④}

Outdoor Catalog Number (no bypass)	Outdoor Catalog Number (horn bypass)	Indoor Catalog Number (no bypass)	Indoor Catalog Number (horn bypass)	Meter Positions Per Stack	Breaker Provision	Maximum AIC ^⑤	Dimensions (inches) ^⑥		
							Height	Width	Depth
Max. tenant breaker (Amps): 125									
WMM21125R	WMM21125RB	MM21125R	MM21125RB	2 Position	QP, QPH, HQP, MP-T, MP-HT, MP-MT	65k	34.31	13.09	8.09
WMM31125R	WMM31125RB	MM31125R	MM31125RB	3 Position		65k	43.31	13.09	8.09
WMM41125R	WMM41125RB	MM41125R	MM41125RB	4 Position		65k	52.31	13.09	8.09
WMM51125R	WMM51125RB	MM51125R	MM51125RB	5 Position		65k	61.31	13.09	8.09
WMM61125R	WMM61125RB	MM61125R	MM61125RB	6 Position		65k	70.31	13.09	8.09
Max. tenant breaker (Amps): 225 ^{②⑥}									
WMM21225R	WMM21225RB	MM21225R	MM21225RB	2 Position	QS, QSH, QSHH, HQS, HQSH, QP, QPH, HQP, MP-T, MP-HT, MP-MT	100k	34.31	16.22	8.09
WMM31225R	WMM31225RB	MM31225R	MM31225RB	3 Position		100k	43.31	16.22	8.09
WMM41225R	WMM41225RB	MM41225R	MM41225RB	4 Position		100k	52.31	16.22	8.09
WMM51225R	WMM51225RB	MM51225R	MM51225RB	5 Position		100k	61.31	16.22	8.09
WMM61225R	WMM61225RB	MM61225R	MM61225RB	6 Position		100k	70.31	16.22	8.09

① Dimensions shown are representative of outside box dimensions and do not include allowances for mounting bumps, endwalls, covers, hubs, or hardware protrusions. Dimensions are subject to change.
 ② 225A available in lower three positions only. 200A continuous for all other positions.
 ③ NOT for use on 3-phase, 4-wire delta systems.
 ④ Field installed 5th jaw ECMF5. 5th jaw can be isolated if needed.
 ⑤ Max AIC determined by maximum AIC of tenant breakers. Higher ratings may be achieved through approved series rating combinations.
 ⑥ Install QP breakers below QS breakers.

Power Mod: Type WMM Residential Meter Stacks

1 phase 5J

- 2-6 gang
- 125/225 Amp per position
- 1200 Amp thru-bus rating



Residential 5-Jaw Ring Type Meter Stacks: 1-Phase, 3-Wire SN, Incoming And Outgoing^{③④}

Outdoor Catalog Number	Indoor Catalog Number	Meter Positions Per Stack	Breaker Provision	Maximum AIC ^⑤	Dimensions (inches) ^①		
					Height	Width	Depth
Max. tenant breaker (Amps): 125							
WMM21125J	MM21125J	2 Position	QP, QPH, HQP, MP-T, MP-HT, MP-MT	65k	34.31	13.09	8.09
WMM31125J	MM31125J	3 Position		65k	43.31	13.09	8.09
WMM41125J	MM41125J	4 Position		65k	52.31	13.09	8.09
WMM51125J	MM51125J	5 Position		65k	61.31	13.09	8.09
WMM61125J	MM61125J	6 Position		65k	70.31	13.09	8.09
Max. tenant breaker (Amps): 225 ^{②⑥}							
WMM21225J	MM21225J	2 Position	QS, QSH, QSHH, HQS, HQSH, QP, QPH, HQP, MP-T, MP-HT, MP-MT	100k	34.31	16.22	8.09
WMM31225J	MM31225J	3 Position		100k	43.31	16.22	8.09
WMM41225J	MM41225J	4 Position		100k	52.31	16.22	8.09
WMM51225J	MM51225J	5 Position		100k	61.31	16.22	8.09
WMM61225J	MM61225J	6 Position		100k	70.31	16.22	8.09

Residential 5-Jaw Ringless Type Meter Stacks: 1-Phase, 3-Wire SN, Incoming and Outgoing^{③④}

Outdoor Catalog Number (no bypass)	Outdoor Catalog Number (horn bypass)	Indoor Catalog Number (no bypass)	Indoor Catalog Number (horn bypass)	Meter Positions Per Stack	Breaker Provision	Maximum AIC ^⑤	Dimensions (inches) ^①		
							Height	Width	Depth
Max. tenant breaker (Amps): 125									
WMM21125RJ	WMM21125RJB	MM21125RJ	MM21125RJB	2 Position	QP, QPH, HQP, MP-T, MP-HT, MP-MT	65k	34.31	13.09	8.09
WMM31125RJ	WMM31125RJB	MM31125RJ	MM31125RJB	3 Position		65k	43.31	13.09	8.09
WMM41125RJ	WMM41125RJB	MM41125RJ	MM41125RJB	4 Position		65k	52.31	13.09	8.09
WMM51125RJ	WMM51125RJB	MM51125RJ	MM51125RJB	5 Position		65k	61.31	13.09	8.09
WMM61125RJ	WMM61125RJB	MM61125RJ	MM61125RJB	6 Position		65k	70.31	13.09	8.09
Max. tenant breaker (Amps): 225 ^{②⑥}									
WMM21225RJ	WMM21225RJB	MM21225RJ	MM21225RJB	2 Position	QS, QSH, QSHH, HQS, HQSH, QP, QPH, HQP, MP-T, MP-HT, MP-MT	100k	34.31	16.22	8.09
WMM31225RJ	WMM31225RJB	MM31225RJ	MM31225RJB	3 Position		100k	43.31	16.22	8.09
WMM41225RJ	WMM41225RJB	MM41225RJ	MM41225RJB	4 Position		100k	52.31	16.22	8.09
WMM51225RJ	WMM51225RJB	MM51225RJ	MM51225RJB	5 Position		100k	61.31	16.22	8.09
WMM61225RJ	WMM61225RJB	MM61225RJ	MM61225RJB	6 Position		100k	70.31	16.22	8.09

① Dimensions shown are representative of outside box dimensions and do not include allowances for mounting bumps, endwalls, covers, hubs, or hardware protrusions. Dimensions are subject to change.
 ② 225A available in lower three positions only. 200A continuous for all other positions.
 ③ NOT for use on 3-phase, 4-wire delta systems.
 ④ Field installed 5th jaw ECMF5. 5th jaw can be isolated if needed.
 ⑤ Max AIC determined by maximum AIC of tenant breakers. Higher ratings may be achieved through approved series rating combinations.
 ⑥ Install QP breakers below QS breakers.

Power Mod: Type WMM Residential Meter Stacks

3 phase in 1 phase out 5J

- 2-6 gang
- 125/225 Amp per position
- 1200 Amp thru-bus rating

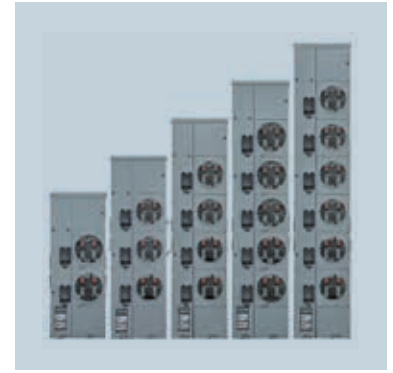

Residential 5-Jaw Ring Type Meter Stacks: 3-Phase, 4-Wire SN, Incoming and 1-Phase, 3 Wire SN Outgoing^{③④⑦}

Outdoor Catalog Number	Indoor Catalog Number	Meter Positions Per Stack	Breaker Provision	Maximum AIC ^⑤	Dimensions (inches) ^①		
					Height	Width	Depth
Max. tenant breaker (Amps): 125							
WMM22125J	MM22125J	2 Position	QP, QPH, HQP, MP-T, MP-HT, MP-MT	65k	34.31	13.09	8.09
WMM32125J	MM32125J	3 Position		65k	43.31	13.09	8.09
WMM42125J	MM42125J	4 Position		65k	52.31	13.09	8.09
WMM52125J	MM52125J	5 Position		65k	61.31	13.09	8.09
WMM62125J	MM62125J	6 Position		65k	70.31	13.09	8.09
Max. tenant breaker (Amps): 225 ^{②③}							
WMM22225J	MM22225J	2 Position	QS, QSH, QSHH, HQS, HQSH, QP, QPH, HQP, MP-T, MP-HT, MP-MT	100k	34.31	16.22	8.09
WMM32225J	MM32225J	3 Position		100k	43.31	16.22	8.09
WMM42225J	MM42225J	4 Position		100k	52.31	16.22	8.09
WMM52225J	MM52225J	5 Position		100k	61.31	16.22	8.09
WMM62225J	MM62225J	6 Position		100k	70.31	16.22	8.09

Residential 5-Jaw Ringless Type Meter Stacks: 3-Phase, 4-Wire SN, Incoming and 1-Phase, 3 Wire SN Outgoing^{③④⑦}

Outdoor Catalog Number (No Bypass)	Outdoor Catalog Number (Horn Bypass)	Indoor Catalog Number (No Bypass)	Indoor Catalog Number (Horn Bypass)	Meter Positions Per Stack	Breaker Provision	Maximum AIC ^⑤	Dimensions (inches) ^①		
							Height	Width	Depth
Max. tenant breaker (Amps): 125									
WMM22125RJ	WMM22125RJB	MM22125RJ	MM22125RJB	2 Position	QP, QPH, HQP, MP-T, MP-HT, MP-MT	65k	34.31	13.09	8.09
WMM32125RJ	WMM32125RJB	MM32125RJ	MM32125RJB	3 Position		65k	43.31	13.09	8.09
WMM42125RJ	WMM42125RJB	MM42125RJ	MM42125RJB	4 Position		65k	52.31	13.09	8.09
WMM52125RJ	WMM52125RJB	MM52125RJ	MM52125RJB	5 Position		65k	61.31	13.09	8.09
WMM62125RJ	WMM62125RJB	MM62125RJ	MM62125RJB	6 Position		65k	70.31	13.09	8.09
Max. tenant breaker (Amps): 225 ^{②③}									
WMM22225RJ	WMM22225RJB	MM22225RJ	MM22225RJB	2 Position	QS, QSH, QSHH, HQS, HQSH, QP, QPH, HQP, MP-T, MP-HT, MP-MT	100k	34.31	16.22	8.09
WMM32225RJ	WMM32225RJB	MM32225RJ	MM32225RJB	3 Position		100k	43.31	16.22	8.09
WMM42225RJ	WMM42225RJB	MM42225RJ	MM42225RJB	4 Position		100k	52.31	16.22	8.09
WMM52225RJ	WMM52225RJB	MM52225RJ	MM52225RJB	5 Position		100k	61.31	16.22	8.09
WMM62225RJ	WMM62225RJB	MM62225RJ	MM62225RJB	6 Position		100k	70.31	16.22	8.09

① Dimensions shown are representative of outside box dimensions and do not include allowances for mounting bumps, endwalls, covers, hubs, or hardware protrusions. Dimensions are subject to change.
 ② 225A available in lower three positions only. 200A continuous for all other positions.
 ③ Approved for use on 3-phase, 4-wire delta systems. Must field phase away from B phase (A & C phase only).
 ④ 5th jaw can be isolated if needed.
 ⑤ Max AIC determined by maximum AIC of tenant breakers. Higher ratings may be achieved through approved series rating combinations.
 ⑥ Install QP breakers below QS breakers.
 ⑦ Stacks come factory phased as AB, BC, AC... top to bottom

Power Mod Lever Bypass Meter Stacks

Commercial Lever Bypass meter stacks (type WML) are designed to meet the requirements of those utilities specifying lever bypass meter sockets for residential and commercial applications.

Features include:

- QuickSystem™ features
- High-quality, time-proven Talon HQ sockets
- A line of 3-phase 100 Amp meter stacks to minimize tenant main cost
- Removable back knockout plate to facilitate wiring
- 225 Amp capability in single and three phase designs
- Up to 4 positions with 225 Amp tenant mains, up to 2 positions with 400 Amp tenant mains
- Ease of wiring – tenant mains require only a single bend

Lever Bypass Quick Reference

- 125A 2-6 position
- 100A/225A 1-4 position
- 400A 1-2 position
- 1200A thru-bus rating
- UL Standard # UL67
- UL file # E27100
- AIC rating (25K, 35K, 65K & 100K)
- Voltage
 - Single phase 120/240V AC max
 - Three in single phase out 208Y/120V AC
 - Three Phase 240V AC max
- All swing latches and rivets are stainless steel.
- Indoor = NEMA 1 rated
- Outdoor = NEMA 3R rated
- G90 galvanized steel
- ANSI 61 paint
- Custom options available! Details on p. 72

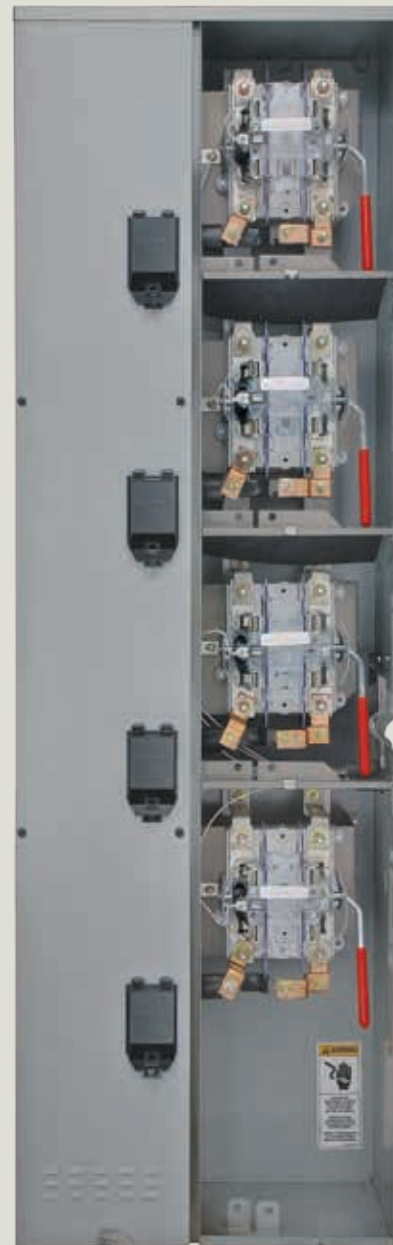

Power Mod: Type WML Lever Bypass Meter Stacks

- 125A 2-6 position
- 1200A thru-bus rating

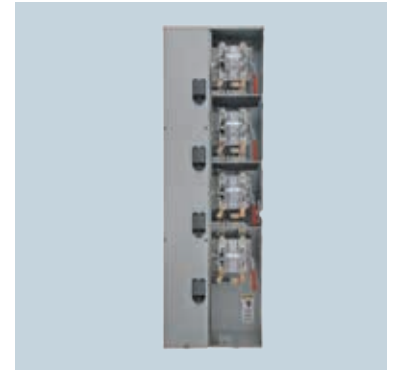

Commercial Ringless Type Meter Stacks: Lever Bypass

Outdoor Catalog Number	Indoor Catalog Number	Meter Positions Per Stack	Breaker Provisions	Maximum AIC ^c	Dimensions (inches) ^a			Stack Phasing Phases/Sockets
					Height	Width	Depth	

1-Phase, 3-Wire SN, Incoming and Outgoing, Lever Bypass, 5-Jaw Sockets^②

Max. tenant breaker (Amps): 125								
WML21125RJ	ML21125RJ	2	QS, QSH, QSHH, HQS, HQSH, QP, QPH, HQP, MP-T, MP-HT, MP-MT	100k	36.18	14.48	11.51	-
WML31125RJ	ML31125RJ	3		100k	46.18	14.48	11.51	-
WML41125RJ	ML41125RJ	4		100k	56.18	14.48	11.51	-
WML51125RJ	ML51125RJ	5		100k	66.18	14.48	11.51	-
WML61125RJ	ML61125RJ	6		100k	76.18	14.48	11.51	-

3-Phase, 4-Wire SN, Incoming and 1-Phase, 3-Wire SN Outgoing, Lever Bypass, 5-Jaw Sockets^{②③}

Max. tenant breaker (Amps): 125								
WML22125RJ	ML22125RJ	2	QS, QSH, QSHH, HQS, HQSH, QP, QPH, HQP, MP-T, MP-HT, MP-MT	100k	36.18	14.48	11.51	-
WML32125RJ	ML32125RJ	3		100k	46.18	14.48	11.51	-
WML42125RJ	ML42125RJ	4		100k	56.18	14.48	11.51	-
WML52125RJ	ML52125RJ	5		100k	66.18	14.48	11.51	-
WML62125RJ	ML62125RJ	6		100k	76.18	14.48	11.51	-

Alternate Amperage Breakers

	1 Meter Position Per Stack	Breaker Amperage
Add Suffix ➤	T1	200A
	T19	225A
	T2	250A
	T3	300A
	T4	350A

	2 Meter Position Per Stack	Breaker Amperage
Add Suffix ➤	T5	200A/200A
	T6	200A/250A
	T7	200/300A
	T8	200/350A
	T9	200/400A
	T10	250A/300A
	T11	250A/350A
	T12	250A/400A
	T13	300A/300A
	T14	300A/350A
	T15	300A/400A
	T16	350A/350A
	T17	350A/400A
	T18	250A/250A
	T20	200A/225A
	T21	225A/225A
	T22	225A/250A
	T23	225A/300A
	T24	225A/350A
	T25	225A/400A

- ① Dimensions shown are representative of outside box dimensions and do not include allowances for mounting bumps, hubs, or hardware protrusions.
- ② Not for use on 3-phase, 4-wire delta systems.
- ③ Max AIC determined by maximum AIC of tenant breakers when used in conjunction with a meter socket. Higher overall ratings may be achieved through approved series rating combinations.
- ④ Alternate amperage breakers are available. Please see table on right for suffix that needs to be added. Additional lead time may apply. Contact sales office for details.
- ⑤ Commercial Stacks are not field phaseable.

Power Mod: Type WML Lever Bypass Meter Stacks

- 225A 1-4 position
- 1200A thru-bus rating



Commercial Ringless Type Meter Stacks: Lever Bypass

Outdoor Catalog Number	Indoor Catalog Number	Meter Positions Per Stack	Breaker Provisions	Maximum AIC ^③	Dimensions (inches) ^①			Stack phasing phases/sockets
					Height	Width	Depth	

1-Phase, 3-Wire SN, Incoming and Outgoing, Lever Bypass, 5-Jaw Sockets^②

Max. tenant breaker (Amps): 225								
WML11225RJ	ML11225RJ	1	QS, QSH, QSHH, HQS, HQSH, QP, QPH, HQP, MP-T, MP-HT, MP-MT	100k	27.75	19.50	9.00	-
WML21225RJ	ML21225RJ	2		100k	40.75	19.50	9.00	-
WML31225RJ	ML31225RJ	3		100k	49.75	19.50	9.00	-
WML41225RJ	ML41225RJ	4		100k	62.75	19.50	9.00	-

3-Phase, 4-Wire SN, Incoming and 1-Phase, 3-Wire SN Outgoing, Lever Bypass, 5-Jaw Sockets^{②④}

Max. tenant breaker (Amps): 225								
WML12225RJ	ML12225RJ	1	QS, QSH, QSHH, HQS, HQSH, QP, QPH, HQP, MP-T, MP-HT, MP-MT	100k	27.75	19.50	9.00	1-AB
WML22AB225RJ	ML22AB225RJ	2		100k	40.75	19.50	9.00	1-AC, 1-BC
WML22BC225RJ	ML22BC225RJ	2		100k	40.75	19.50	9.00	1-AC, 1-AB
WML22CA225RJ	ML22CA225RJ	2		100k	40.75	19.50	9.00	1-AB, 1-BC
WML32225RJ	ML32225RJ	3		100k	49.75	19.50	9.00	1-AB, 1-BC, 1-CA
WML42AB225RJ	ML42AB225RJ	4		100k	62.75	19.50	9.00	2-AB, 1-BC, 1-CA
WML42BC225RJ	ML42BC225RJ	4		100k	62.75	19.50	9.00	1-AB, 2-BC, 1-CA
WML42CA225RJ	ML42CA225RJ	4		100k	62.75	19.50	9.00	1-AB, 1-BC, 2-CA

Alternate Amperage Breakers

	1 Meter Position Per Stack	Breaker Amperage
Add Suffix ➤	T1	200A
	T19	225A
	T2	250A
	T3	300A
	T4	350A

	2 Meter Position Per Stack	Breaker Amperage
Add Suffix ➤	T5	200A/200A
	T6	200A/250A
	T7	200/300A
	T8	200/350A
	T9	200/400A
	T10	250A/300A
	T11	250A/350A
	T12	250A/400A
	T13	300A/300A
	T14	300A/350A
	T15	300A/400A
	T16	350A/350A
	T17	350A/400A
	T18	250A/250A
	T20	200A/225A
	T21	225A/225A
	T22	225A/250A
	T23	225A/300A
	T24	225A/350A
	T25	225A/400A

- ① Dimensions shown are representative of outside box dimensions and do not include allowances for mounting bumps, hubs, or hardware protrusions.
- ② Not for use on 3-phase, 4-wire delta systems.
- ③ Max AIC determined by maximum AIC of tenant breakers when used in conjunction with a meter socket. Higher overall ratings may be achieved through approved series rating combinations.
- ④ Alternate amperage breakers are available. Please see table on right for suffix that needs to be added. Additional lead time may apply. Contact sales office for details.
- ⑤ Commercial Stacks are not field phaseable.

Power Mod: Type WML Lever Bypass Meter Stacks

- 100A/225A 1-4 position
- 1200A thru-bus rating



Commercial Ringless Type Meter Stacks: Lever Bypass

Outdoor Catalog Number	Indoor Catalog Number	Meter Positions Per Stack	Breaker Provisions	Maximum AIC ^③	Dimensions (inches) ^①		
					Height	Width	Depth

3-Phase, 4-Wire SN, Incoming And Outgoing, Lever Bypass, 7-Jaw Sockets^⑤

Max. tenant breaker (Amps) ^③ : 100							
WML13100RJ ^②	ML13100RJ ^②	1	QP, MP-T, QPH, MP-HT, HQP, MP-MT	65k	27.75	23.50	9.00
WML23100RJ ^②	ML23100RJ ^②	2		65k	40.75	23.50	9.00
WML33100RJ ^②	ML33100RJ ^②	3		65k	49.75	23.50	9.00
WML43100RJ ^②	ML43100RJ ^②	4		65k	62.75	23.50	9.00
Max. tenant breaker (Amps) ^③ : 225							
WML13225RJ	ML13225RJ	1	QR2, QRH2, QR2H, MQ, MQH, MQL	100k	27.75	23.50	9.00
WML23225RJ	ML23225RJ	2		100k	40.75	23.50	9.00
WML33225RJ	ML33225RJ	3		100k	49.75	23.50	9.00
WML43225RJ	ML43225RJ	4		100k	62.75	23.50	9.00

Alternate Amperage Breakers

	1 Meter Position Per Stack	Breaker Amperage
Add Suffix ➤	T1	200A
	T19	225A
	T2	250A
	T3	300A
	T4	350A

	2 Meter Position Per Stack	Breaker Amperage
Add Suffix ➤	T5	200A/200A
	T6	200A/250A
	T7	200/300A
	T8	200/350A
	T9	200/400A
	T10	250A/300A
	T11	250A/350A
	T12	250A/400A
	T13	300A/300A
	T14	300A/350A
	T15	300A/400A
	T16	350A/350A
	T17	350A/400A
	T18	250A/250A
	T20	200A/225A
	T21	225A/225A
	T22	225A/250A
	T23	225A/300A
	T24	225A/350A
	T25	225A/400A

- ① Dimensions shown are representative of outside box dimensions and do not include allowances for mounting bumps, hubs, or hardware protrusions.
- ② 3-pole breakers only.
- ③ Max AIC determined by maximum AIC of tenant breakers when used in conjunction with a meter socket. Higher overall ratings may be achieved through approved series rating combinations.
- ④ Alternate amperage breakers are available. Please see below table for suffix that needs to be added. Additional lead time may apply. Contact sales office for details.
- ⑤ Rated for use with 240/120V Delta systems.

Power Mod: Type WML Lever Bypass Meter Stacks

- 400A 1-2 position
- 1200A thru-bus rating
- 25-35KAIC



Commercial Ringless Type Meter Stacks: Lever Bypass

Outdoor Catalog Number	Indoor Catalog Number	Meter Positions Per Stack	Breaker Provisions	Maximum AIC ^③	Dimensions (inches) ^①			Stack Phasing Phases/Sockets
					Height	Width	Depth	

1-Phase, 3-Wire SN, Incoming and Outgoing, Lever Bypass, 5-Jaw Sockets^②

Max. tenant breaker (Amps): 400								
WML11400RJ ^④	ML11400RJ ^④	1	JXD62B400 Factory inst	25k	44.00	16.31	9.69	-
WML21400RJ ^④	ML21400RJ ^④	2		25k	70.38	23.00	9.69	-

3-Phase, 4-Wire SN, Incoming and 1-Phase, 3-Wire SN Outgoing, Lever Bypass, 5-Jaw Sockets^{② ⑤}

Max. tenant breaker (Amps): 400								
WML12400RJ ^④	ML12400RJ ^④	1	JXD62B400 Factory Inst	25k	44.00	16.31	9.69	1-AB
WML22400RJ ^④	ML22400RJ ^④	2		25k	70.38	23.00	9.69	1-AB, 1-BC

3-Phase, 4-Wire SN, Incoming and Outgoing, Lever Bypass, 7-Jaw Sockets^②

Max. tenant breaker (Amps) ^③ : 400								
WML13400RJ ^④	ML13400RJ ^④	1	JXD63B400 Factory Inst	25k	44.00	16.31	9.69	-
WML23400RJ ^④	ML23400RJ ^④	2		25k	70.38	23.00	9.69	-

Commercial Ringless Type Meter Stacks: Lever Bypass

Max. tenant breaker (Amps) ^③ : 400								
WML11400RJH	-	1	CJD6-A	35k	51.06	16.34	9.75	-
WML12400RJH	-	1		35k	51.06	16.34	9.75	-
WML13400RJH	-	1		35k	51.06	16.34	9.75	-

Alternate Amperage Breakers

Ad Suffix ➤	1 Meter Position Per Stack	Breaker Amperage
	T1	200A
	T19	225A
	T2	250A
	T3	300A
	T4	350A

Ad Suffix ➤	2 Meter Position Per Stack	Breaker Amperage
	T5	200A/200A
	T6	200A/250A
	T7	200/300A
	T8	200/350A
	T9	200/400A
	T10	250A/300A
	T11	250A/350A
	T12	250A/400A
	T13	300A/300A
	T14	300A/350A
	T15	300A/400A
	T16	350A/350A
	T17	350A/400A
	T18	250A/250A
	T20	200A/225A
	T21	225A/225A
	T22	225A/250A
	T23	225A/300A
	T24	225A/350A
	T25	225A/400A

- ① Dimensions shown are representative of outside box dimensions and do not include allowances for mounting bumps, hubs, or hardware protrusions.
- ② Not for use on 3-phase, 4-wire delta systems.
- ③ Max AIC determined by maximum AIC of tenant breakers when used in conjunction with a meter socket. Higher overall ratings may be achieved through approved series rating combinations.
- ④ Alternate amperage breakers are available. Please see table on right for suffix that needs to be added. Additional lead time may apply. Contact sales office for details.
- ⑤ Commercial Stacks are not field phaseable.

Power Mod Fusible Switch Lever Bypass Meter Stacks

Fusible Switch Lever Bypass Meter stacks This Commercial Lever Bypass meter stacks (type WML) feature a 400 Amp - class T - fusible pull out assembly.

Features include:

- QuickSystem™ features
- High-quality, time proven Talon HQ sockets
- Removable back knockout plate to facilitate wiring
- Available in single and three phases designs
- Single position with 400amp tenant main
- Ease of wiring

Lever Bypass With Fusible Switch Quick Reference:

- 400A 1 position
- 1200A thru bus rating
- UL Standard #UL67
- UL file #E27100
- AIC rating 100KAIC
- Voltage
 - Single phase 120/240V AC Max
 - Three phase in, single phase out 208Y/120V AC
 - Three Phase 240V AC Max
- All swing latches and rivets are stainless steel
- Outdoor = NEMA 3R rated
- Indoor = NEMA 1 rated
- G90 galvanized steel
- ANSI 61 paint
- Custom options available! Details on page 72.



Power Mod: Fusible Switch Lever Bypass Meter Stacks

- 400A 1 position
- 1200A thru-bus rating
- 400A Class T fuse



Single-Phase In/Out; Three-Phase In/ Single-Phase Out; Three-Phase In/Out

Outdoor Catalog Number	Indoor Catalog Number	Meter Positions Per Stack	Breaker Provisions	Maximum AIC	Dimensions (inches) ^①		
					Height	Width	Depth
Max. Tenant Breaker (Amps): 400							
WML11400RJFS	ML11400RJFS	1	Class T fuse	100K	38.31	16.34	11.22
WML12400RJFS	ML12400RJFS	1		100K	38.31	16.34	11.22
WML13400RJFS	ML13400RJFS	1		100K	38.31	16.34	11.22

① Dimensions shown are representative of the outside box dimensions and do not include allowances for mounting bumps, hubs, or hardware protrusions.



Power Mod Fusible Switch Lever Bypass Meter Stacks

The WMLZ and WMLZF lever bypass meter stacks are designed to allow the use of class T (400amp max) fuses ahead of all meter positions where the local serving utility may require it. WMLZF stacks feature a 400amp fusible pull out assembly which connects to a secondary 400amp thru bus that can feed downstream meter stacks. The WMLZ stacks include the secondary 400amp thru bus that can connect from the WMLZF meter stacks. The standard Power Mod 1200amp thru bus "passes thru" to feed downstream modules - the meter sockets in WMLZ and WMLZF do NOT connect directly to the 1200amp thru bus - only to the 400amp thru bus.

Features include:

- QuickSystem™ features
- High-quality, time-proven Talon HQ sockets
- 125 Amp capability for 3-phase in/single-phase out
- 3 to 6 positions in both the fused stack and the expansion stack
- 400 Amp class T fusible-pullout in WMLZF stacks
- Secondary 400 amp thru bus to supply power to downstream sockets
- Ease of wiring – tenant mains require only a single bend
- Preconfigured and wired

Xcel Residential Lever Bypass Quick Reference:

- 125A 3 – 6 position
- 1200A thru-bus rating
- 400A secondary thru-bus rating & vertical bus rating
- UL Standard # UL67
- UL file #E27100
- AIC rating (100K)
- Voltage -Three-phase in/ single-phase out 120/240V AC max
- All swing latches and rivets are stainless steel
- Outdoor = NEMA 3R rated
- Indoor = NEMA 1R rated
- G90 galvanized steel
- ANSI 61 paint
- Custom options available! Details on page 72.



Power Mod: Type WMLZF & WMLZ Xcel Utility Meter Stacks

- 125A 3 – 6 position
- 1200A thru-bus
- 400A 2nd thru-bus
- 400A vertical bus



Fused Residential Ringless Type Stacks: Lever Bypass

Outdoor Catalog Number	Indoor Catalog Number	Meter Positions Per Stack	Breaker Provisions	Maximum AIC	Dimensions (inches)		
					Height	Width	Depth

3-Phase, 4-Wire SN, Incoming and 1Phase, 3-Wire SN, Outgoing, Lever Bypass, 5-Jaw Sockets

Max. tenant breaker (Amps): 125							
WMLZF32125RJ	MLZF32125RJ	3	QP, MP-T, QPH, HQP, MP-HT, MP-MT	100k	54.06	14.61	11.51
WMLZF42125RJ	MLZF42125RJ	4		100k	64.06	14.61	11.51
WMLZF52125RJ	MLZF52125RJ	5		100k	74.06	14.61	11.51
WMLZF62125RJ	MLZF62125RJ	6		100k	84.06	14.61	11.51



Non-Fused Residential Ringless Type Stacks: Lever Bypass

Outdoor Catalog Number	Indoor Catalog Number	Meter Positions Per Stack	Breaker Provisions	Maximum AIC	Dimensions (inches)		
					Height	Width	Depth

3-Phase, 4-Wire SN, Incoming and 1Phase, 3-Wire SN, Outgoing, Lever Bypass, 5-Jaw Sockets

Max. tenant breaker (Amps): 125							
WMLZ32125RJ	MLZ32125RJ	3	QP, MP-T, QPH, HQP, MP-HT, MP-MT	100k	54.06	14.61	11.51
WMLZ42125RJ	MLZ42125RJ	4		100k	64.06	14.61	11.51
WMLZ52125RJ	MLZ52125RJ	5		100k	74.06	14.61	11.51
WMLZ62125RJ	MLZ62125RJ	6		100k	84.06	14.61	11.51



Accessories

Catalog Number	Description
ECWMLZFBUS	WMLZ's thru bussing attachment kit
ECWMLZEP	End enclosure plate WMLZ's & WMLZF's
ECWMLZBP	Bottom enclosure plate WMLZ & WMLZF
ECWML10	10 inch WML replacement cover

* Every WMLZ comes with a ECWMLZFBUS

Power Mod Test Block Bypass Meter Stacks

Commercial Test Block Bypass Meter Stacks (type WMT) are designed to meet the requirements of those utilities specifying test block bypass meter sockets for commercial applications in areas subscribing to the EUSERC standards.

Features include:

- QuickSystem™ features
- High-quality, time-proven Siemens SMM switchboard meter socket
- Removable back knockout plate to facilitate wiring
- 225 Amp capability in single and three phase designs
- Up to 3 positions with 225 Amp tenant mains
- Wiring flexibility - tenant mains require only a single bend
- Three phase input, single phase output modules
- In line wiring: side knockouts allow wiring for adjacent units to pass through

Test Block Bypass Quick Reference

- 225A 1-3 positions
- 1200A thru-bus rating
- UL Standard #'s UL67
- UL file # E27100
- AIC Rating (100k)
- Voltage
 - Single phase 120/240V AC max
 - 3 phase in single phase out 120Y/208V AC max
 - Three phase 240V AC max
- All swing latches and rivets are stainless steel
- Outdoor= NEMA 3R rated
- Indoor= NEMA 3R rated
- G90 galvanized steel
- ANSI 61 paint
- EUSERC drawing numbers 312 and 353
- Custom options available! Details on p. 72



Power Mod: Type WMT Test Block Bypass Meter Stacks

- 225A 1-3 positions
- 1200A thru-bus rating
- AIC Rating (100k)



Commercial Ring Type Meter Stacks: Test Block Bypass^③

Outdoor Catalog Number	Indoor Catalog Number	Meter Positions Per Stack	Breaker Provisions	Maximum AIC	Dimensions (inches) ^①			Phase
					Height	Width	Depth	

1-Phase, 3-Wire SN, Incoming and Outgoing, Test Block Bypass, 4-Jaw Sockets^②

Max. tenant breaker (Amps): 225								
WMT11225	MT11225	1	QS, QSH, QSHH, HQS, HQSH, QP, QPH, HQP, MP-T, MP-HT, MP-MT	100k	40.50	21.50	9.00	—
WMT21225	MT21225	2			46.00	21.50	9.00	—
WMT31225	MT31225	3			65.50	21.50	9.00	—

3-Phase, 4-Wire SN, Incoming and 1-Phase, 3-Wire SN Outgoing, Test Block Bypass, 5-Jaw Sockets^{②⑤}

Max. tenant breaker (Amps): 225								
WMT12225J	MT12225J	1	QS, QSH, QSHH, HQS, HQSH, QP, QPH, HQP, MP-T, MP-HT, MP-MT	100k	40.50	21.50	9.00	AB
WMT22AB225J	MT22AB225J	2			46.00	21.50	9.00	1-BC, 1-CA
WMT22BC225J	MT22BC225J	2			46.00	21.50	9.00	1-AB, 1-CA
WMT22CA225J	MT22CA225J	2			46.00	21.50	9.00	1-AB, 1-BC
WMT32225J	MT32225J	3			65.50	21.50	9.00	1-AB, 1-BC, 1-CA

3-Phase, 4-Wire SN, Incoming and Outgoing, Test Block Bypass, 7-Jaw Sockets^④

Max. tenant breaker (Amps): 225								
WMT13225J	MT13225J	1	QR2, QRH2, QR2H, MQ, MQH, MQL	100k	40.50	25.50	9.00	—
WMT23225J	MT23225J	2			46.00	25.50	9.00	—
WMT33225J	MT33225J	3			65.50	25.50	9.00	—

- ① Dimensions shown are representative of outside box dimensions and do not include allowances for mounting bumps, hubs, or hardware protrusions.
 ② Not for use on 3-phase,4-wire delta systems.
 ③ Max AIC determined by maximum AIC of tenant breakers when used in conjunction with a meter socket.
 ④ Rated for use with 240/120V Delta systems.
 ⑤ Commercial Stacks are not field phaseable.

Power Mod K-Base Meter Stacks

Commercial K-Base Meter Stacks (type WMK) are designed to meet the requirements of those utilities specifying bolt-in meter sockets for 400 and 600 Amp residential and commercial applications.

Features include:

- QuickSystem™ features
- Exclusive Landis & Gyr K4, K5, & K7 meter sockets
- 1 position K4, K5, K7 modules with 400 & 600 Amp tenant mains
- 2 position K7 module with 400 Amp tenant main
- Space saving design

K-Base Quick Reference

- 400A & 600A 1-2 positions
- 1200A Thru bus-rating
- UL Standard # UL67
- UL file # E27100
- AIC Rating (25k)
- Voltage
 - Single Phase 120/240V AC Max
 - Three In Single Phase Out 208Y/120V AC
 - Three Phase 240V AC Max
- All swing latches and rivets are stainless steel
- NEMA 3R rated
- G90 Galvanized Steel
- ANSI 61 Paint
- Custom options available! Details on p.72



Power Mod: Type WMK K-Base Meter Stacks

- 400A & 600A
1-2 positions
- 1200A Thru bus-
rating
- AIC Rating (25k)



Commercial Ringless Type Meter Stacks: K-Base Bolt-In, 25k AIC^{③⑥}

Catalog Number	Meter Positions Per Stack	Max. Tenant Breaker (Amps)	Breaker Provision ^④	Maximum AIC Rating	Dimensions (inches) ^①			Phase
					Height	Width	Depth	
1-Phase, 3-Wire SN, Incoming and Outgoing, K4 K-Base Bolt-In								
WMK11400R ^②	1	400	JXD62B400 Factory Inst.	25k	54.00	19.25	10.00	—
WMK11600R ^②	1	600	LXD62B600 Factory Inst.	25k	54.00	19.25	10.00	—
3-Phase, 4-Wire SN, Incoming and 1-Phase, 3-Wire SN Outgoing, K5 K-Base Bolt-In^{②⑥}								
WMK12400RJ ^④	1	400	JXD62B400 Factory Inst.	25k	54.00	19.25	10.00	AB
WMK22400RJ	2	400	JXD62B400 Factory Inst.	25k	72.87	27.00	11.00	AC
3-Phase, 4-Wire SN, Incoming and Outgoing, K7 K-Base Bolt-In^⑤								
WMK13400RJ ^④	1	400	JXD63B400 Factory Inst.	25k	54.00	19.25	10.00	—
WMK23400RJ ^④	2				72.88	27.00	11.00	—
WMK13600RJ ^②	1	600	LXD63B600 Factory Inst.	25k	54.00	19.25	10.00	—

① Dimensions shown are representative of outside box dimensions and do not include allowances for mounting bumps, hubs, or hardware protrusions.

② Not for use on 3-Phase 4-wire delta systems.

③ Max AIC determined by maximum AIC of tenant breakers when used in conjunction with a meter socket. Higher overall ratings may be achieved through approved series rating combinations.

④ Alternate amperage breakers are available. Please see table below for suffix that needs to be added for ordering. Extended leadtime may apply. Contact sales office for more details.

⑤ Rated for use with 240/120V Delta systems

⑥ Commercial Stacks are not field phaseable

⑦ Alternate amperage breakers are available (T19 and T20). Please see table below for suffix that needs to be added for ordering. Extended leadtime may apply. Contact sales office for more details.

Alternate Amperage Breakers

Add Suffix ➤	1 Meter Position Per Stack	Breaker Amperage	Add Suffix ➤	1 Meter Position Per Stack	Breaker Amperage
	T1	200A		T5	200A/200A
	T20	500A		T6	200A/250A
	T2	250A		T7	200/300A
	T3	300A		T8	200/350A
	T4	350A		T9	200/400A
	T19	450A		T10	250A/300A
				T11	250A/350A
		T12	250A/400A		
		T13	300A/300A		
		T14	300A/350A		
		T15	300A/400A		
		T16	350A/350A		
		T17	350A/400A		
		T18	250A/250A		

Power Mod WC Series House Power Module

Power Mod's patented WC family of house power modules offers the ability to combine power distribution to branch circuits within a module that is connected directly to the thru bus. This reduces wall space needed, decreases labor and material cost (for installing a separate panel), and simplifies the electrical distribution system.

Key Features of the WC family are:

- Ring or Ringless Covers (horn bypass available with ringless)
- Three or single phase thru bus with single phase output
- 20 space, 40 circuit 100K AIC rated interior
- Available subfeed breaker which can be used for large remote loads (such as elevators) or alternative energy inputs (solar)
- Removable knock out plate
- Load wires can exit out of the top, back, or bottom

The line of WC house power modules allow for un-precedented flexibility and savings. All of this while featuring the industry-leading QuickSystem that allows for the fastest install time.



Series House Power Module Quick Reference

- 1 Position, Single Phase Meter Socket
- 250 Amp maximum rating per device.
Load center interior limited to 225 Amps max.
1200 Amp thru-bus rating
- UL standard 67
- UL file no. E27100
- AIC rating: 100k
- Voltage:
 - Single phase 120/240V AC max.
 - Three phase in single phase out
 - 120/208V AC max.
 - 240/120V AC max.
- All swing latches and rivets are stainless steel.
- Outdoor= NEMA 3R rated
- 20 space, 40 circuit PL Series copper bus interior
- G90 galvanized steel
- ANSI 61 paint
- Optional subfeed or alternative energy input (solar) up to 125Amps.
- Custom options available! Details on p. 72.



Power Mod: Type WC House Power Module

Ring Style

Main Features:

- 1 Position, Single Phase Meter Socket
- 250 Amp maximum rating per device. Load center interior limited to 225Amps max.
- 1200 Amp thru-bus rating



Residential 4-Jaw Ring Type Meter-Loadcenter Stacks: 1-Phase, 3-wire, SN, Thru Bus, Distribution, & Subfeed

Catalog Number	Main Breaker - Distribution ^②		Distribution		Subfeed Breaker (Type HED4) ^②	Maximum AIC	Dimensions (inches) ^①		
	Amperage	Type	Spaces	Circuits	Amperage		Height	Width	Depth
WC2040B1T1	225	HFXD6	20	40	N/A	100k	39.10	16.22	12.14
WC2040B1T2	200	HFXD6	20	40	50	100k	39.10	21.75	12.14
WC2040B1T3	175	HFXD6	20	40	60	100k	39.10	21.75	12.14
WC2040B1T4	175	HFXD6	20	40	70	100k	39.10	21.75	12.14
WC2040B1T5	150	HFXD6	20	40	80	100k	39.10	21.75	12.14
WC2040B1T6	150	HFXD6	20	40	90	100k	39.10	21.75	12.14
WC2040B1T7	150	HFXD6	20	40	100	100k	39.10	21.75	12.14
WC2040B1T8	150	HFXD6	20	40	110	100k	39.10	21.75	12.14
WC2040B1T9	125	HFXD6	20	40	125	100k	39.10	21.75	12.14

Residential 5-Jaw Ring Type Meter-Loadcenter Stacks: 3-Phase, 4-wire SN, Thru Bus and 1-Phase, 3-wire, SN, Distribution, & Subfeed

Catalog Number	Main Breaker - Distribution ^②		Distribution		Subfeed Breaker (Type HED4) ^②	Maximum AIC	Dimensions (inches) ^①			Phasing ^③
	Amperage	Type	Spaces	Circuits	Amperage		Height	Width	Depth	
WC2040B2T1J	225	HFXD6	20	40	N/A	100k	39.10	16.22	12.14	AC
WC2040B2T2J	200	HFXD6	20	40	50	100k	39.10	21.75	12.14	AC
WC2040B2T3J	175	HFXD6	20	40	60	100k	39.10	21.75	12.14	AC
WC2040B2T4J	175	HFXD6	20	40	70	100k	39.10	21.75	12.14	AC
WC2040B2T5J	150	HFXD6	20	40	80	100k	39.10	21.75	12.14	AC
WC2040B2T6J	150	HFXD6	20	40	90	100k	39.10	21.75	12.14	AC
WC2040B2T7J	150	HFXD6	20	40	100	100k	39.10	21.75	12.14	AC
WC2040B2T8J	150	HFXD6	20	40	110	100k	39.10	21.75	12.14	AC
WC2040B2T9J	125	HFXD6	20	40	125	100k	39.10	21.75	12.14	AC

① Dimensions shown are representative of outside box dimensions and do not include allowances for mounting bumps, endwalls, covers, hubs, or hardware protrusions. Dimensions are subject to change.

② Breakers are factory installed.

③ Can be re-phased in the field.

Power Mod: Type WC House Power Module

Ringless Style

- Main Features:**
- 1 Position, Single Phase Meter Socket
 - 250 Amp maximum rating per device. Load center interior limited to 225Amps max.
 - 1200 Amp thru-bus rating

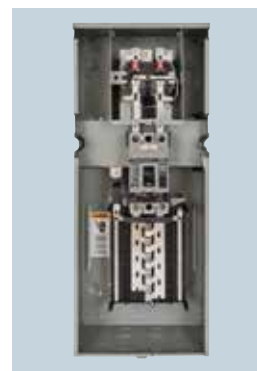

Residential 4 or 5-Jaw Ringless Type Meter-Loadcenter Stacks: 1-Phase, 3-Wire, SN, Thru Bus, Distribution, & Subfeed

Catalog Number			Main Breaker-Distribution ^②		Distribution		Subfeed Breaker (Type HED4) ^②		Dimensions ^①		
No Bypass, 4J	No bypass, 5J	Horn Bypass, 5J	Amperage	Type	Spaces	Circuits	Amperage	Maximum AIC	Height	Width	Depth
WC2040B1T1R	WC2040B1T1RJ	WC2040B1T1RJB	225	HFXD6	20	40	N/A	100k	39.10	16.22	12.14
WC2040B1T2R	WC2040B1T2RJ	WC2040B1T2RJB	200	HFXD6	20	40	50	100k	39.10	21.75	12.14
WC2040B1T3R	WC2040B1T3RJ	WC2040B1T3RJB	175	HFXD6	20	40	60	100k	39.10	21.75	12.14
WC2040B1T4R	WC2040B1T4RJ	WC2040B1T4RJB	175	HFXD6	20	40	70	100k	39.10	21.75	12.14
WC2040B1T5R	WC2040B1T5RJ	WC2040B1T5RJB	150	HFXD6	20	40	80	100k	39.10	21.75	12.14
WC2040B1T6R	WC2040B1T6RJ	WC2040B1T6RJB	150	HFXD6	20	40	90	100k	39.10	21.75	12.14
WC2040B1T7R	WC2040B1T7RJ	WC2040B1T7RJB	150	HFXD6	20	40	100	100k	39.10	21.75	12.14
WC2040B1T8R	WC2040B1T8RJ	WC2040B1T8RJB	150	HFXD6	20	40	110	100k	39.10	21.75	12.14
WC2040B1T9R	WC2040B1T9RJ	WC2040B1T9RJB	125	HFXD6	20	40	125	100k	39.10	21.75	12.14

Residential 5-Jaw Ringless Type Meter-Loadcenter Stacks: 3-Phase, 4-Wire SN, Thru Bus and 1-Phase, 3-Wire, SN, Distribution & Subfeed

Catalog Number		Main Breaker-Distribution ^②		Distribution		Subfeed Breaker (Type HED4) ^②		Dimensions ^①			
No Bypass	Horn Bypass	Amperage	Type	Spaces	Circuits	Amperage	Maximum AIC	Height	Width	Depth	Phasing ^③
WC2040B2T1RJ	WC2040B2T1RJB	225	HFXD6	20	40	N/A	100k	39.10	16.22	12.14	AC
WC2040B2T2RJ	WC2040B2T2RJB	200	HFXD6	20	40	50	100k	39.10	21.75	12.14	AC
WC2040B2T3RJ	WC2040B2T3RJB	175	HFXD6	20	40	60	100k	39.10	21.75	12.14	AC
WC2040B2T4RJ	WC2040B2T4RJB	175	HFXD6	20	40	70	100k	39.10	21.75	12.14	AC
WC2040B2T5RJ	WC2040B2T5RJB	150	HFXD6	20	40	80	100k	39.10	21.75	12.14	AC
WC2040B2T6RJ	WC2040B2T6RJB	150	HFXD6	20	40	90	100k	39.10	21.75	12.14	AC
WC2040B2T7RJ	WC2040B2T7RJB	150	HFXD6	20	40	100	100k	39.10	21.75	12.14	AC
WC2040B2T8RJ	WC2040B2T8RJB	150	HFXD6	20	40	110	100k	39.10	21.75	12.14	AC
WC2040B2T9RJ	WC2040B2T9RJB	125	HFXD6	20	40	125	100k	39.10	21.75	12.14	AC

① Dimensions shown are representative of outside box dimensions and do not include allowances for mounting bumps, endwalls, covers, hubs, or hardware protrusions. Dimensions are subject to change.

② Breakers are factory installed.

③ Can be re-phased in the field.

Power Mod WCL Series House Power Module

Power Mod's patented WCL (lever bypass) family of house power modules offers the ability to combine power distribution to branch circuits within a module that is connected directly to the thru bus. This reduces wall space needed, decreases labor and material cost (for installing a separate panel), and simplifies the electrical distribution system.

Key Features of the WCL family are:

- Talon HQ Lever Bypass ringless meter socket
- Phasing:
 - Single phase thru bus with single phase HQ socket and 20 space 40 circuit PL Series copper interior
 - Three phase thru bus with single phase HQ socket (phased AC) and 20 space 40 circuit PL Series copper interior
 - Three phase thru bus with three phase HQ socket and 24 space 42 circuit PL Series copper interior
- 100K AIC
- Available subfeed breaker which can be used for large remote loads (such as elevators) or alternative energy inputs (solar)
- Removable knock out plate
- Load wires can exit out of the top, back, or bottom

The line of WCL house power modules allow for unprecedented flexibility and savings. All of this while featuring the industry-leading QuickSystem that allows for the fastest install time.

Lever Bypass Series House Power Module Quick Reference

- Talon HQ Lever Bypass Meter Socket
- 1 Position, Single Phase Meter Socket
- 250 Amp maximum rating per device. Load center interior limited to 225 Amps max. 1200A thru-bus rating
- UL Standard # UL67
- UL file # E27100
- AIC rating 100K
- Voltage
 - Single phase 120/240V AC max
 - Three phase
 - 120/208V AC max.
 - 240/120V AC max.
- All swing latches and rivets are stainless steel.
- Outdoor= NEMA 3R rated
- Interiors: 20 space/40 circuit single phase or 24 space 42 circuit three phase PL Series copper bus
- G90 Galvanized Steel
- ANSI 61 Paint
- Optional subfeed or alternative energy input (solar) up to 125 Amps.
- Custom options available! Details on p. 72.



Power Mod: Type WCL Lever Bypass House Power Module

- Main Features:**
- Talon HQ Lever Bypass Meter Socket
 - 1 Position, Single Phase Meter Socket
 - 250amp maximum rating per device. Load center interior limited to 225 Amps max.
 - 1200A thru-bus rating



Residential 4 or 5-Jaw Ringless Type Meter-Loadcenter Stacks: 1-Phase, 3-Wire, SN, Thru Bus, Distribution, & Subfeed

Catalog Number	Main Breaker-Distribution ^②		Distribution		Subfeed Breaker (Type HED4) ^②	Maximum AIC	Dimensions ^①		
	Amperage	Type	Spaces	Circuits	Amperage		Height	Width	Depth
WCL2040B1T1RJ	225	HFXD6	20	40	N/A	100k	44.63	17.93	12.14
WCL2040B1T2RJ	200	HFXD6	20	40	50	100k	44.63	22.35	12.14
WCL2040B1T3RJ	175	HFXD6	20	40	60	100k	44.63	22.35	12.14
WCL2040B1T4RJ	175	HFXD6	20	40	70	100k	44.63	22.35	12.14
WCL2040B1T5RJ	150	HFXD6	20	40	80	100k	44.63	22.35	12.14
WCL2040B1T6RJ	150	HFXD6	20	40	90	100k	44.63	22.35	12.14
WCL2040B1T7RJ	150	HFXD6	20	40	100	100k	44.63	22.35	12.14
WCL2040B1T8RJ	150	HFXD6	20	40	110	100k	44.63	22.35	12.14
WCL2040B1T9RJ	125	HFXD6	20	40	125	100k	44.63	22.35	12.14

Commercial 5-Jaw Ringless Type-Lever Bypass Meter-Loadcenter Stacks: 3-Phase, 4-Wire SN, Thru Bus and 1-Phase, 3-Wire, SN, Distribution & Subfeed

Catalog Number	Main Breaker-Distribution ^②		Distribution		Subfeed Breaker (Type HED4) ^②	Maximum AIC	Dimensions ^①			Phasing ^③
	Amperage	Type	Spaces	Circuits	Amperage		Height	Width	Depth	
WCL2040B2T1RJ	225	HFXD6	20	40	N/A	100k	44.63	17.93	12.14	AC
WCL2040B2T2RJ	200	HFXD6	20	40	50	100k	44.63	22.35	12.14	AC
WCL2040B2T3RJ	175	HFXD6	20	40	60	100k	44.63	22.35	12.14	AC
WCL2040B2T4RJ	175	HFXD6	20	40	70	100k	44.63	22.35	12.14	AC
WCL2040B2T5RJ	150	HFXD6	20	40	80	100k	44.63	22.35	12.14	AC
WCL2040B2T6RJ	150	HFXD6	20	40	90	100k	44.63	22.35	12.14	AC
WCL2040B2T7RJ	150	HFXD6	20	40	100	100k	44.63	22.35	12.14	AC
WCL2040B2T8RJ	150	HFXD6	20	40	110	100k	44.63	22.35	12.14	AC
WCL2040B2T9RJ	125	HFXD6	20	40	125	100k	44.63	22.35	12.14	AC

Commercial 7-Jaw Ringless Type-Lever Bypass Meter-Loadcenter Stacks: 3-Phase, 4-Wire SN, Thru Bus, Distribution & Subfeed

Catalog Number	Main Breaker-Distribution ^②		Distribution		Subfeed Breaker (Type HED4) ^②	Maximum AIC	Dimensions ^①			Phasing ^③
	Amperage	Type	Spaces	Circuits	Amperage		Height	Width	Depth	
WCL2442B3T1RJ	225	HFXD6	24	42	N/A	100k	44.63	17.93	12.14	AC
WCL2442B3T2RJ	200	HFXD6	24	42	50	100k	44.63	22.35	12.14	AC
WCL2442B3T3RJ	175	HFXD6	24	42	60	100k	44.63	22.35	12.14	AC
WCL2442B3T4RJ	175	HFXD6	24	42	70	100k	44.63	22.35	12.14	AC
WCL2442B3T5RJ	150	HFXD6	24	42	80	100k	44.63	22.35	12.14	AC
WCL2442B3T6RJ	150	HFXD6	24	42	90	100k	44.63	22.35	12.14	AC
WCL2442B3T7RJ	150	HFXD6	24	42	100	100k	44.63	22.35	12.14	AC
WCL2442B3T8RJ	150	HFXD6	24	42	110	100k	44.63	22.35	12.14	AC
WCL2442B3T9RJ	125	HFXD6	24	42	125	100k	44.63	22.35	12.14	AC

① Dimensions shown are representative of outside box dimensions and do not include allowances for mounting bumps, endwalls, covers, hubs, or hardware protrusions. Dimensions are subject to change.

② Breakers are factory installed.

③ Cannot be re-phased in the field.

Power Mod WCT Series House Power Module

Power Mod's patented WCT (test-block bypass) family of house power modules offers the ability to combine power distribution to branch circuits within a module that is connected directly to the thru bus. This reduces wall space needed, decreases labor and material cost (for installing a separate panel), and simplifies the electrical distribution system.

Key Features of the WCT family are:

- Siemens SMM Switchboard ring-style meter socket
- Phasing:
 - Single phase thru bus with a single phase meter socket and 20 space 40 circuit PL Series copper interior
 - Three phase thru bus with a single phase meter socket (phased AC) and 20 space 40 circuit PL Series copper interior
 - Three phase thru bus with three phase meter socket and 24 space 42 circuit PL Series copper interior
- 100K AIC
- Available subfeed breaker which can be used for large remote loads (such as elevators) or alternative energy inputs (solar)
- Removable knock out plate
- Load wires can exit out of the top, back, or bottom

The line of WCT house power modules allow for un-precedented flexibility and savings. All of this while featuring the industry-leading QuickSystem that allows for the fastest install time.



Test Block Bypass Series House Power Module Quick Reference

- Siemens SMM Switchboard ring-style
- 1 Position, Single Phase Meter Socket
- 250amp maximum rating per device. Load center interior limited to 225 Amps max. 1200 Amp thru-bus rating.
- UL Standard #'s UL67
- UL file # E27100
- AIC Rating 100k
- Voltage:
 - Single phase 120/240V AC max.
 - Three phase
 - 120/208V AC max.
 - 240/120V AC max.
- All swing latches and rivets are stainless steel
- Outdoor= NEMA 3R rated
- Interiors: 20 space/40 circuit single phase or 24 space 42 circuit three phase PL Series copper bus
- G90 galvanized steel
- ANSI 61 paint
- Optional subfeed or alternative energy input (solar) up to 125Amps
- EUSERC drawing numbers 312 and 353
- Custom options available! Details on p. 72



Power Mod: Type WCT Test Block Bypass House Power Module

- Main Features:**
- Siemens SMM Switchboard ring-style
 - Phase Meter Socket
 - 250amp maximum rating per device. Load center interior limited to 225Amps max.
 - 1200 Amp thru-bus rating.



Commercial 5-Jaw Ring Type-Test Block Bypass Meter-Loadcenter Stacks: 1-Phase, 3-Wire, SN, Thru Bus, Distribution, & Subfeed

Catalog Number	Main Breaker-Distribution ^①		Distribution		Subfeed Breaker (Type HED4) ^②	Maximum AIC	Dimensions ^①		
	Amperage	Type	Spaces	Circuits	Amperage		Height	Width	Depth
WCT2040B1T1	225	HFXD6	20	40	N/A	100k	52.1	18.42	12.14
WCT2040B1T2	200	HFXD6	20	40	50	100k	52.1	18.42	12.14
WCT2040B1T3	175	HFXD6	20	40	60	100k	52.1	18.42	12.14
WCT2040B1T4	175	HFXD6	20	40	70	100k	52.1	18.42	12.14
WCT2040B1T5	150	HFXD6	20	40	80	100k	52.1	18.42	12.14
WCT2040B1T6	150	HFXD6	20	40	90	100k	52.1	18.42	12.14
WCT2040B1T7	150	HFXD6	20	40	100	100k	52.1	18.42	12.14
WCT2040B1T8	150	HFXD6	20	40	110	100k	52.1	18.42	12.14
WCT2040B1T9	125	HFXD6	20	40	125	100k	52.1	18.42	12.14

Commercial 5-Jaw Ring Type-Test Block Bypass Meter-Loadcenter Stacks: 3-Phase, 4-Wire SN, Thru Bus and 1-Phase, 3-Wire, SN, Distribution & Subfeed

Catalog Number	Main Breaker-Distribution ^①		Distribution		Subfeed Breaker (Type HED4) ^②	Maximum AIC	Dimensions ^①			Phasing ^③
	Amperage	Type	Spaces	Circuits	Amperage		Height	Width	Depth	
WCT2040B2T1J	225	HFXD6	20	40	N/A	100k	52.1	18.42	12.14	AC
WCT2040B2T2J	200	HFXD6	20	40	50	100k	52.1	18.42	12.14	AC
WCT2040B2T3J	175	HFXD6	20	40	60	100k	52.1	18.42	12.14	AC
WCT2040B2T4J	175	HFXD6	20	40	70	100k	52.1	18.42	12.14	AC
WCT2040B2T5J	150	HFXD6	20	40	80	100k	52.1	18.42	12.14	AC
WCT2040B2T6J	150	HFXD6	20	40	90	100k	52.1	18.42	12.14	AC
WCT2040B2T7J	150	HFXD6	20	40	100	100k	52.1	18.42	12.14	AC
WCT2040B2T8J	150	HFXD6	20	40	110	100k	52.1	18.42	12.14	AC
WCT2040B2T9J	125	HFXD6	20	40	125	100k	52.1	18.42	12.14	AC

Commercial 5-Jaw Ring Type-Test Block Bypass Meter-Loadcenter Stacks: 3-Phase, 4-Wire SN, Thru Bus, Distribution & Subfeed

Catalog Number	Main Breaker-Distribution ^①		Distribution		Subfeed Breaker (Type HED4) ^②	Maximum AIC	Dimensions ^①			Phasing ^③
	Amperage	Type	Spaces	Circuits	Amperage		Height	Width	Depth	
WCT2442B3T1J	225	HFXD6	24	42	N/A	100k	52.1	18.42	12.14	AC
WCT2442B3T2J	200	HFXD6	24	42	50	100k	52.1	18.42	12.14	AC
WCT2442B3T3J	175	HFXD6	24	42	60	100k	52.1	18.42	12.14	AC
WCT2442B3T4J	175	HFXD6	24	42	70	100k	52.1	18.42	12.14	AC
WCT2442B3T5J	150	HFXD6	24	42	80	100k	52.1	18.42	12.14	AC
WCT2442B3T6J	150	HFXD6	24	42	90	100k	52.1	18.42	12.14	AC
WCT2442B3T7J	150	HFXD6	24	42	100	100k	52.1	18.42	12.14	AC
WCT2442B3T8J	150	HFXD6	24	42	110	100k	52.1	18.42	12.14	AC
WCT2442B3T9J	125	HFXD6	24	42	125	100k	52.1	18.42	12.14	AC

① Dimensions shown are representative of outside box dimensions and do not include allowances for mounting bumps, endwalls, covers, hubs, or hardware protrusions. Dimensions are subject to change.

② Breakers are factory installed.

③ Cannot be re-phased in the field.

Power Mod WSPD Surge Protection Modules

Surge protection modules for Power Mod (type WSPD) are thru-bus connected modules that allow the user to view surge status as well as access the SPD control panel without breaking the utility seal on the enclosure. An optional breaker disconnect is available to enable the end user to replace the SPD (surge protection device) without having to disconnect utility power to the Power Mod installation.

Features include:

- QuickSystem™ features
- 100, 200, 300, 400, 500kA ratings available
- External, vandal resistant & lockable clear cover over SPD control panel
- Single phase thru bus and three phase thru bus
- Optional breaker disconnect that opens phase & neutral to make SPD replacement quick and easy

Surge Protection Module Quick Reference

- 100-500 kA rating
- 1200amp thru-bus rating
- UL standard #67
- UL file # E27100
- AIC rating: 100K
- Voltage
 - Single phase 120/240V AC max
 - Three phase 240V AC max
- All swing latches and rivets are stainless steel
- NEMA 3R rated
- ANSI 61 paint
- Custom options available! Details on p. 72



Power Mod: Type WSPD Surge Protection Modules

- Main Features:**
- 100-500kA ratings
 - 1200 amp thru-bus
 - Suitable for 100k AIC applications

Lugs not required.
Quick Connect sold separately.



1-Phase, 3-Wire SN, 120/240V AC

Catalog Number (with HEG Breaker Disconnect)	Catalog Number (no disconnect)	Breaker Type	kA Surge Current ^②	Dimensions (inches) ^①		
				Height	Width	Depth
WSPD1B10A	WSPD1N10A	HEG	100	29.19	13.38	7.91
WSPD1B20A	WSPD1N20A	HEG	200	29.19	13.38	7.91
WSPD1B30A	WSPD1N30A	HEG	300	29.19	13.38	7.91
WSPD1B40A	WSPD1N40A	HEG	400	29.19	13.38	7.91
WSPD1B50A	WSPD1N50A	HEG	500	29.19	13.38	7.91

3-Phase, 4-Wire SN, Delta 240/120V AC

Catalog Number (with HEG Breaker Disconnect)	Catalog Number (no disconnect)	Breaker Type	kA Surge Current ^②	Dimensions (inches) ^①		
				Height	Width	Depth
WSPD3B10B	WSPD3N10B	HEG	100	29.19	13.38	7.91
WSPD3B20B	WSPD3N20B	HEG	200	29.19	13.38	7.91
WSPD3B30B	WSPD3N30B	HEG	300	29.19	13.38	7.91
WSPD3B40B	WSPD3N40B	HEG	400	29.19	13.38	7.91
WSPD3B50B	WSPD3N50B	HEG	500	29.19	13.38	7.91

3-Phase, 4-Wire SN, Wye 208/120V AC

Catalog Number (with HEG Breaker Disconnect)	Catalog Number (no disconnect)	Breaker Type	kA Surge Current ^②	Dimensions (inches) ^①		
				Height	Width	Depth
WSPD3B10C	WSPD3N10C	HEG	100	29.19	13.38	7.91
WSPD3B20C	WSPD3N20C	HEG	200	29.19	13.38	7.91
WSPD3B30C	WSPD3N30C	HEG	300	29.19	13.38	7.91
WSPD3B40C	WSPD3N40C	HEG	400	29.19	13.38	7.91
WSPD3B50C	WSPD3N50C	HEG	500	29.19	13.38	7.91

① Dimensions shown are representative of outside box dimensions and do not include allowances for mounting bumps, endwalls, covers, hubs, or hardware protrusions. Dimensions are subject to change.

② 200 - 500kA devices require additional lead time. Please contact sales office for details on lead time.

Power Mod: WMMB Aux Pull Box & MS_UBD Switches

Main Features:

- EUSERC compliant incoming pull section
- Dual cover handles
- Single and three phase models



EUSERC Compliant Pullbox Modules: 1-Phase, 3-Wire SNn, Incoming , 120/240V Ac Max.®

Catalog Number	Ampere Rating	Withstand Rating ^②	Service Feed	Dimensions (inches) ^①			KO Drawing No.	Line Terminal Lugs No. And Size Per Line And Neutral
				Height	Width	Depth		
WMMB1400	400	65,000	UG	37.50	16.69	9.34	P-1	1 set of 2 studs 
WMMB1800	800	65,000	UG	45.50	19.44	12.72	P-2	1 set of 2 studs 
WMMB11200	1200	65,000	UG	47.50	25.94	12.72	P-3	3 sets of 2 studs 

EUSERC Compliant Pullbox Modules: 3-Phase, 4-Wire SN, Incoming, 240V AC max.®

Catalog Number	Ampere Rating	Withstand Rating ^②	Service Feed	Dimensions (inches) ^①			KO Drawing No.	Line Terminal Lugs No. And Size Per Line And Neutral
				Height	Width	Depth		
WMMB3400	400	65,000	UG	37.50	16.69	9.34	P-1	1 set of 2 studs 
WMMB3800	800	65,000	UG	45.50	25.94	12.72	P-2	2 set of 2 studs 
WMMB31200	1200	65,000	UG	47.50	33.83	12.72	P-3	3 sets of 2 studs 

MS_UBD Bus Duct Connected Switch Mains^④

Catalog Number	Ampere Rating	Dimensions (Inches) ^①			Mechanism Type	AIC Rating
		Height	Width	Depth		
MS44UBD	400	33.00	15.00	14.94	Class T fuse	100,000
MS64UBD	600	33.00	15.00	14.94		
MS84UBD	800	33.00	15.00	14.94		

① Dimensions shown are representative of outside box dimensions and do not include allowances for mounting bumps, endwalls, covers, hubs, or hardware protrusions. Dimensions are subject to change.

② Devices rated for 22,000. 65,000 rating requires cables to be tied together. Please see instructions with pullbox for details.

③ Devices do not have thru bus.

④ All devices are build to order. Tap stack and QuickConnect sold separately.

Power Mod: Lug Kits, Custom Options, Elbows, & Spacers

Siemens offers a wide range of accessories and custom options to help product fit your application. Eliminate the need for special orders with replacement part kits available for your convenience. All kits come with appropriate hardware and instruction sheets for safe installation.

Meet local requirements and save on labor with custom factory installed options and custom paint colors.



Quick Reference

For lugs:

- UL486A/B
- 750 kcmil maximum wire size (may vary by catalog number)
- Tin plated aluminum extrusions

For QS Breaker:

For Elbow & Spacers:

- NEMA 1R Elbows
- 9" Spacers

Custom options

Factory installed:

- Tenant breakers
- 5th jaw
- Lugs and Lug Landing Pad
- Shunt Trips

Custom Colors:

- Desert tan
- Forest Green
- Custom Match Options

Power Mod: Modular Metering Lug Kits

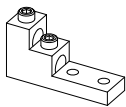
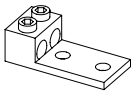
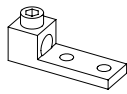
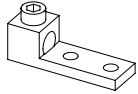
		Lug Kit Contents			
		Wire Range: 1/0-750 kcmil  Wire Binding Screw Torque: 500 lb.-in.	Wire Range: #6-350 kcmil  Wire Binding Screw Torque: 275 lb.-in.	Wire Range: #2-600 kcmil  Wire Binding Screw Torque: 500 lb.-in.	Wire Range: 300-800 kcmil  Wire Binding Screw Torque: 500 lb.-in.
Lug Kit Catalog Number	Wire Range	Lug Qty.	Lug Qty.	Lug Qty.	Lug Qty.
LK12350N2	#6-350 kcmil		3		
LK32350N2	#6-350 kcmil		4		
LK12500N2	1/0-500 kcmil	3			
LK32500N2	1/0-500 kcmil	4			
LK12500N2E	#2-500 kcmil			6	
LK32500N2E	#2-500 kcmil			8	
LK13500N2	1/0-500 kcmil	3		3	
LK33500N2	1/0-500 kcmil	4		4	
LK14500N2	1/0-500 kcmil	6			
LK34500N2	1/0-500 kcmil	8			
LK14500N2E	1/0-500 kcmil	3		6	
LK34500N2E	1/0-500 kcmil	4		8	
LK15600N2	1/0-600 kcmil	6		3	
LK35600N2	1/0-600 kcmil	8		4	
LK11600N2	#2-600 kcmil			3	
LK31600N2	#2-600 kcmil			4	
LK12600N2	#2-600 kcmil			6	
LK32600N2	#2-600 kcmil			8	
LK11750N2	300-750 kcmil				3
LK31750N2	300-750 kcmil				4
LK12750N2	300-750 kcmil				6
LK32750N2	300-750 kcmil				8
LK13750N2	300-750 kcmil	3			3
LK33750N2	300-750 kcmil	4			4
LK13750N2E	300-750 kcmil				9
LK33750N2E	300-750 kcmil				12
LK15750N2	300-750 kcmil	6			3
LK35750N2	300-750 kcmil	8			4
LK16750N2	1/0-750 kcmil	9			
LK36750N2	1/0-750 kcmil	12			

Power Mod: Lug Kits

Lug selector

Lug kits are available to meet the growing demand for multiple wiring configurations using aluminum and copper conductors in today's market. PowerMod™ offers a variety of lug configurations for every breaker, switch, and tap box module. Lugs are factory installed on standard breaker modules 200A-1200A. Alternate lug kits options (including 750kcmil) are available.

A field installable compression lug landing pad is available as an accessory for standard breaker module 250A-1200A. Compression lug kits must be ordered in addition to the lug landing pad accessory.

Lug kits must be ordered separately for standard breaker modules 1400A-2000A.

All EUSERC breaker main, standard switch, EUSERC switch, standard tapbox, and EUSERC tapbox require lugs to be ordered separately and field installed.

Use the chart below to identify the proper lug kit based on the conductor size required.

For example, if you have (1) 1200 single phase tapbox, and are running (3) 750 kcmil wires per phase, you would order (1) LK13750N2

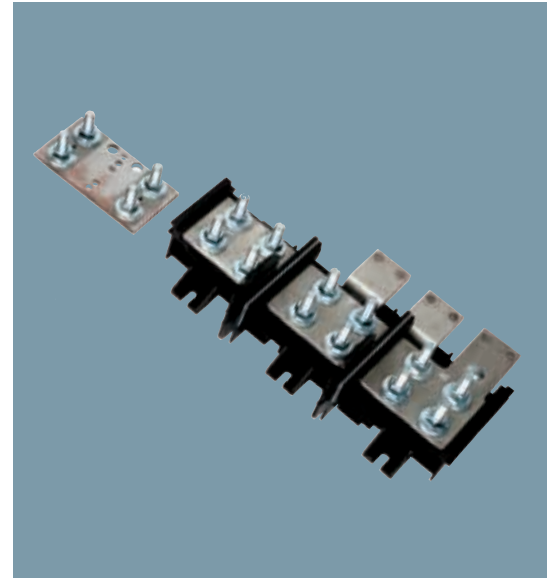

How to use the Power Mod lug selector:

1. Select enclosure from top
2. Choose applicable wire size
3. Select number of conductors being run beside appropriate amperage and phase to find correct lug kit part number

		Type WTB			Type WB			
		Standard Tapbox			Standard Breaker			
		Wire size	500	600	750	500	600	750
1 Phase	Amperage	# Conductors						
	1 Phase	200 - 400	1	n/a	LK11600N2	n/a	n/a	n/a
2			LK12500N2	n/a	n/a	LK12500 ^{①②}	n/a	n/a
500 - 600		2	n/a	n/a	n/a	LK12500 ^{①②}	n/a	n/a
		2	n/a	LK12600N2	LK12750N2	n/a	n/a	n/a
700 - 800		3	LK13500N2	n/a	n/a	LK13500 ^{①②}	n/a	LK13750 ^①
		3	n/a	n/a	LK13750N2	n/a	n/a	LK13750 ^①
900 - 1200		4	LK14500N2	n/a	n/a	LK14500 ^{①②}	n/a	n/a
		5	n/a	LK15600N2	LK15750N2	n/a	LK15600N2	LK15750N2
2000	6	n/a	n/a	n/a	n/a	n/a	LK16750N2	
2400	8	LK18500N2C ^③	n/a	LK18750N2A ^③	n/a	n/a	n/a	
3 Phase	200 - 400	1	n/a	LK31600N2	n/a	n/a	n/a	LK31750 ^①
		2	LK32500N2	n/a	n/a	LK32500 ^{①②}	n/a	n/a
	500 - 600	2	n/a	n/a	n/a	LK32500 ^{①②}	n/a	n/a
		2	n/a	LK32600N2	LK32750N2	n/a	n/a	n/a
	700 - 800	3	LK33500N2	n/a	n/a	LK33500 ^{①②}	n/a	LK33750 ^①
		3	n/a	n/a	LK33750N2	n/a	n/a	LK33750 ^①
	900 - 1200	4	LK34500N2	n/a	n/a	LK34500 ^{①②}	n/a	n/a
		5	n/a	LK35600N2	LK35750N2	n/a	LK35600N2	LK35750N2
2000	6	n/a	n/a	n/a	n/a	n/a	LK36750N2	
2400	8	LK38500N2C ^③	n/a	LK38750N2A ^③	n/a	n/a	n/a	

① Lug kits -Sentron mechanical breaker lugs
 ② Factory installed lugs
 ③ Lug kits for 2400A WT & WTB Tap Boxes ONLY!

Power Mod: Lug Kits

Lug selector (cont.)

Type WB + Lug Landing Pad				Type WS			Types WET, WES, WEB, WT ^④		
Lug kits for Lug Landing Pad on Standard Breaker Module ^③				Standard Fusible Switch			Pullbox combination units		
350	500	600	750	500	600	750	500	600	750
n/a	n/a	LK11600N2	n/a	n/a	LK11600N2	LK11750N2	n/a	n/a	LK11750N2
LK12350N2	n/a	n/a	n/a	LK12500N2	n/a	n/a	LK12500N2	n/a	n/a
LK12350N2	n/a	n/a	n/a	LK12500N2	n/a	n/a	LK12500N2E	n/a	LK12750N2
n/a	n/a	LK12600N2	LK12750N2	n/a	LK12600N2	LK12750N2	n/a	LK12600N2	LK12750N2
n/a	LK13500N2	n/a	n/a	LK13500N2	n/a	n/a	LK13500N2	n/a	n/a
n/a	n/a	n/a	LK13750N2	n/a	n/a	n/a	n/a	n/a	LK13750N2E
n/a	LK14500N2	n/a	n/a	LK14500 ^②	n/a	n/a	LK14500N2E	n/a	n/a
n/a	n/a	n/a	n/a	n/a	n/a	n/a	n/a	LK15600N2 ^⑤	LK15750N2 ^⑤
n/a	n/a	n/a	n/a	n/a	n/a	n/a	n/a	n/a	n/a
n/a	n/a	n/a	n/a	n/a	n/a	n/a	LK18500N2C ^⑤	n/a	LK18750N2A ^⑤
n/a	n/a	LK31600N2	n/a	n/a	LK31600N2	LK31750N2	n/a	n/a	LK31750N2
LK32350N2	n/a	n/a	n/a	LK32500N2	n/a	n/a	LK32500N2	n/a	n/a
LK32350N2	n/a	n/a	n/a	LK32500N2	n/a	n/a	LK32500N2E	n/a	LK32750N2
n/a	n/a	LK32600N2	LK32750N2	n/a	LK32600N2	LK32750N2	n/a	LK32600N2	LK32750N2
n/a	LK33500N2	n/a	n/a	LK33500N2	n/a	n/a	LK33500N2	n/a	n/a
n/a	n/a	n/a	LK33750N2	n/a	n/a	n/a	n/a	n/a	LK33750N2E
n/a	LK34500N2	n/a	n/a	LK34500 ^②	n/a	n/a	LK34500N2E	n/a	n/a
n/a	n/a	n/a	n/a	n/a	n/a	n/a	n/a	LK35600N2 ^⑤	LK35750N2 ^⑤
n/a	n/a	n/a	n/a	n/a	n/a	n/a	n/a	n/a	n/a
n/a	n/a	n/a	n/a	n/a	n/a	n/a	LK38500N2C ^⑤	n/a	LK38750N2A ^⑤

① Lug kits - Sentron mechanical breaker lugs

② Factory installed lugs

③ Lug landing pad must be ordered in addition to lug kit. Refer to page 71 for lug landing pad options.

④ WT tapboxes require 2 lug kits when used on feed thru applications.

⑤ Lug kits for 2400A WT & WTB Tap Boxes ONLY!

Power Mod: Custom Options, Elbows, & Spacers

Custom options

Power Mod offers custom options exclusive to the industry. Avoid time consuming field modifications and realize labor savings through factory installed options. Meet local aesthetic requirements with custom color paint options. Eliminate the need to repaint enclosures and risk splattering paint on bus or meter socket components.①:



Desert Tan



Forest Green

Description

Custom colors:

- Desert tan
- Forest Green
- Color match available upon request



Configure in COMPAS

① Contact sales office for ordering instructions and lead time

Bussed Elbow and Bussed Extensions/Spacers

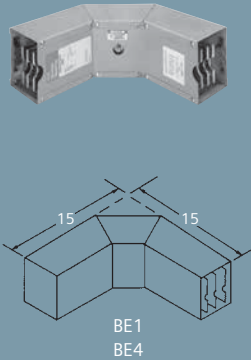
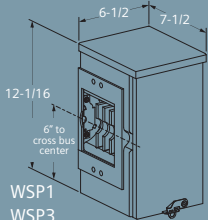
	Catalog Number	Description	Dimensions (inches) ①		
			Height	Length	Width
Bussed Elbows 	BE1	Indoor Bussed Elbow, 1-phase, 3-wire, 1200 Amp maximum	15.06	15.06	4.87
	BE4	Indoor Bussed Elbow, 3-phase, 4-wire, 1200 Amp maximum	15.06	15.06	4.87
	BE112	Indoor Bussed Elbow, 12", 1-phase, 3-wire, 1200 Amp maximum	12.00	12.00	4.87
	BE412	Indoor Bussed Elbow, 12", 3-phase, 4-wire, 1200 Amp maximum	12.00	12.00	4.87
Bussed Extensions/ Spacers 	WSP1	Outdoor Bussed Extension, 1-phase, 3-wire, 1200 Amp maximum	12.00	7.25	6.25
	WSP3	Outdoor Bussed Extension, 3-phase, 4-wire, 1200 Amp maximum	12.00	7.25	6.25

① Dimensions shown are representative of outside box dimensions and do not include allowances for mounting bumps, endwalls, covers, hubs, or hardware protrusions. Dimensions are subject to change.

Features include:

- Siemens exclusive 200 ampere/position feature the QS breaker for faster & easier installation
- Removable knock-out plate for back exit
- Mounting rail for wall hanging - Siemens Exclusive
- UL Listed for use with 60/75C degree wire
- Outdoor/indoor construction
- Overhead or underground service; load top, bottom or back

Standard Uni-Pak Quick Reference

- ANSI - Standard #C 12.7-1987
- NEMA - Standard #250-1985
- UL - File #E27100
- UL - Standard #50, 67,414
- Voltage 240V AC Maximum
- 125 amp or 200 amp Maximum per position
- 1000 Amps maximum bus
- 2-6 positions

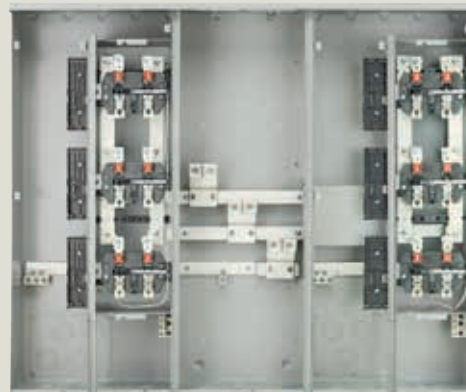

Uni-PAK Features & Benefits



Sturdy Steel Base Pan

Provides reinforcing durable support for each tenant main breaker.



Handle

available on larger devices to make lifting the unit easier.

Line Lugs Factory Installed (WP, WEP, WPC)



2 Pole up to 225A @100kAIC

Fits in 2 inch – compact width reduces enclosure size limiting total mounting space required.

Rigid Molded Side Wall

Provides reinforcing vertical support for each tenant main breaker.

Main Breaker Retainer

Ensures secure connection for breaker wiring.

125 amp breakers can go into 225 amp positions without conversion kits.



Barrel Lock Capable Covers

Accepts common utility barrel locks to protect against unauthorized usage.



Lockable Breaker Cover

Top And Bottom Exit

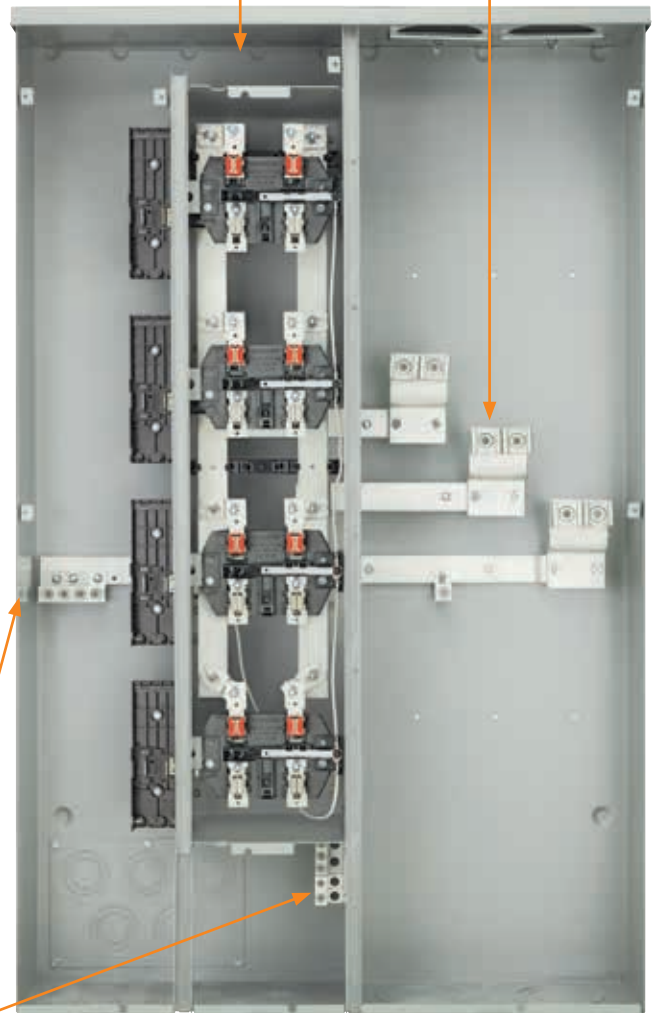

1 Extra Neutral And Ground Termination

Uni-PAK Features & Benefits

Mounting Rail

Simplified mounting by using a separate rail to hang the device.

5Th Jaw Option

Located in 6 or 9 o'clock position. Factory or field installed

Horn Bypass Option

Factory or field installed.

Front Accessible Connections

All connections use similar hardware and use belleville washers for tight connections.

Ring Or Ringless Covers

Individual ring or ringless type meter covers. Ring to ringless kits available to make last minute cover changes for specified utility requirements.

Apartment No. Emboss

Provides convenience and organization.

Removable Back End KO Plate

Simplifies and speeds up pulling wire. Entire plate can be removed to allow ample space for wire. Knockouts in the plate can be removed before or after stack installation.

More Features

- 1) Large range of ampacities 200- 1000A
- 2) 125 amp continuous duty sockets feed plug-in tenant breakers through 125 Amps
- 3) 200 amp continuous duty sockets feed plug-in tenant breakers through 225 Amps
- 4) UL Listed for short circuit ratings up to 100,000 RMS symmetrical Amps at 240V AC
- 5) Lever Bypass models available
- 6) EUSERC compliant models available
- 7) 2 - 6 number of meter positions
- 8) Outdoor/indoor construction
- 9) Overhead or underground service; load top, bottom or back
- 10) Compact design for ease of handling and installation
- 11) All unmetered bus is barriered and sealable to prevent unauthorized access.
- 12) Electrodeposited paint provides uniform coverage for long-lasting protection and sharp appearance
- 13) Complies with the following industry standards
 - ANSI - Standard # C 12.7-1987
 - NEMA - Standard #250-1985
 - UL - File #E10703
 - UL - Standard#50, 67, 414

Rain Channel

Rotates out of the way for easy KO access



Uni-PAK: Type WP Ring & Ringless Style

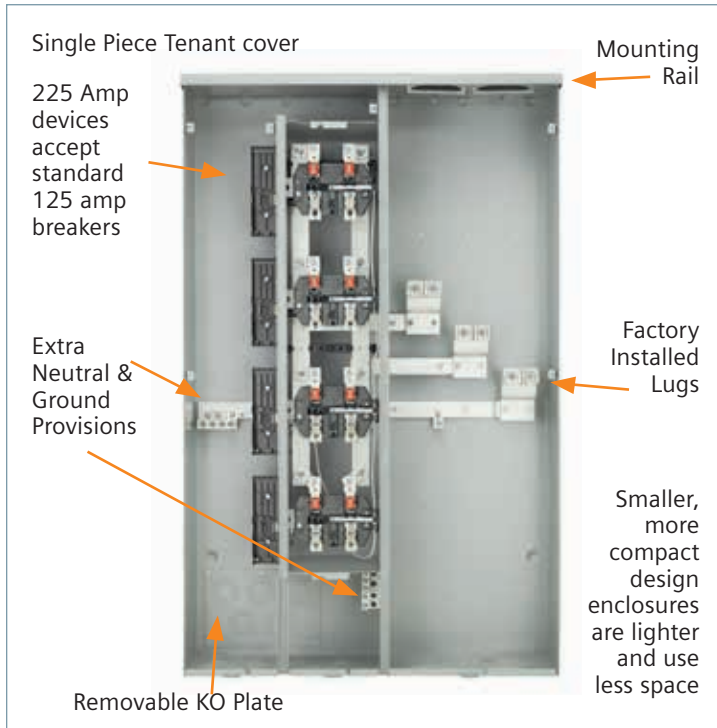

- ### Features
- Individual split covers
 - Ring & ringless Style Meter Construction
 - UL Listed for 60 / 75°C conductors. See equipment markings for applications
 - For small apartment buildings, small professional and commercial buildings
 - Completely self-contained meter centers
 - Two to six 125A and 225A sockets breaker positions
 - Outdoor surface mounted enclosures
 - Compact, pre-bussed, easy to handle, hang and wire
 - Barrired, sealable compartment for unmetered current-carrying parts
 - Al/Cu lay-in lugs, except two position 125A units
 - Top or bottom feed
 - Bottom and rear branch wiring exits (Neutral and ground at bottom only)
 - ANSI #61 light gray electrodeposited paint on zinc-coated G90 steel
 - Field installable 5th jaw kit

Uni-PAK: Type WP Ring Style

Ring Style Uni-PAK 120/240V 1 Phase, 3 Wire

Maximum Tenant Main	Bus Amperage	Meter Positions Per Pak	NEW Catalog Number	Breaker Provision	Max. AIC	Dimensions ^①			5th Jaw Assembly	Line Lugs Wire Range
						Height	Width	Depth		
125	200	2	WP2211	QP, QPH, HQP, MP-T, MP-HT, MP-MT	65,000	26.26	13.80	5.81	ECMF5 6:00 or 9:00	#6-300 kcmil
	300	3	WP3311			38.75	25.42	#2-600 kcmil		
	400	4	WP4411			47.75	38.95	1/0-750 kcmil CU-AL or (2) 1/0-250 AL or (2) 1/0-3/0 CU		
		5	WP4511			47.75				
	500	4	WP5411			26.47	39.01	(2) #2-600 kcmil		
		5	WP6511			26.47				
600	6	WP6611	40.01	7.56						
225	400	2	WP4212	QP, QPH, HQP, MP-T, MP-HT, MP-MT, QS, QSH, QSHH, HQS, HQSH	100,000	29.75	28.53	7.56	ECMF5 6:00 or 9:00	1/0-750 kcmil CU-AL or (2) 1/0-250 AL or (2) 1/0-3/0 CU
		3	WP4312			38.75				
		4	WP4412			47.75				
	600	5	WP6512			29.59	46.22			(2) #2-600 kcmil
		6	WP6612			29.59				
	800	6	WP8612			51.03	38.78			(2) 1/0-750 kcmil or (4) 1/0-250 AL or (4) 1/0-3/0 CU
1000			WP10612 NEW			(3) #2-500 kcmil				

① Dimensions shown are representative of outside box dimensions and do not include allowances for mounting bumps, endwalls, covers, hubs, or hardware protrusions. Dimensions are subject to change.

Uni-PAK: Type WP Ringless Style, No Bypass

Ringless Style Uni-PAK 120/240V 1 Phase, 3 wire, No Bypass

Max. Tenant Main	Bus Amperage	Meter Positions Per Pak	Catalog Number	Breaker Provision	Max. AIC	Dimensions ^①			5th Jaw Assembly	Horn Bypass Kit	Line Lugs Wire Range
						Height	Width	Depth			
125	200	2	WP2211RJ	QP, QPH, HQP, MP-T, MP-HT, MP-MT	65,000	26.26	13.79	5.81	INCL. - 9:00 factory, 6:00 field	ECMFH	#6-300 kcmil
	300	3	WP3311RJ			38.75	25.42	#2-600 kcmil			
	400	4	WP4411RJ			47.75	38.95	1/0-750 kcmil CU-AL or (2) 1/0-250 AL or (2) 1/0-3/0 CU			
		5	WP4511RJ			38.75					
	6	WP4611RJ	47.75			26.47	(2) #2-600 kcmil				
	500	4	WP5411RJ			38.75	39.01	1/0-750 kcmil CU-AL or (2) 1/0-250 AL or (2) 1/0-3/0 CU			
600	5	WP6511RJ	40.01	40.01							
225	400	2	WP4212RJ	QP, QPH, HQP, MP-T, MP-HT, MP-MT, QS, QSH, QSHH, HQS, HQSH	100,000	29.75	28.53	7.56	INCL. - 9:00 factory, 6:00 field	ECMFH	1/0-750 kcmil CU-AL or (2) 1/0-250 AL or (2) 1/0-3/0 CU
		3	WP4312RJ			38.75					
		4	WP4412RJ			47.75					
	600	5	WP6412RJ			29.59	46.22				(2) #2-600 kcmil
		6	WP6512RJ			38.75					
	800	6	WP8612RJ				51.03				(2) 1/0-750 kcmil or (4) 1/0-250 AL or (4) 1/0-3/0 CU
1000	6	WP10612RJ	(3) #2-500 kcmil								

Uni-PAK: Type WP Ringless Style, Horn Bypass

Ringless Style Uni-PAK 120/240V 1 Phase, 3 Wire, Horn Bypass

Max. Tenant Main	Bus Amperage	Meter Positions Per Pak	Catalog Number	Breaker Provision	Max. AIC	Dimensions ^①			5th Jaw Assembly	Line Lugs Wire Range	
						Height	Width	Depth			
125	200	2	WP2211RJB	QP, QPH, HQP, MP-T, MP-HT, MP-MT	65,000	26.26	13.79	5.81	INCL. - 9:00 factory, 6:00 field	ECMFH	#6-300 kcmil
	300	3	WP3311RJB			38.75	25.42	#2-600 kcmil			
	400	4	WP4411RJB			47.75	38.95	1/0-750 kcmil CU-AL or (2) 1/0-250 AL or (2) 1/0-3/0 CU			
		5	WP4511RJB			38.75					
	6	WP4611RJB	47.75			26.47	(2) #2-600 kcmil				
	500	4	WP5411RJB			38.75	40.00	1/0-750 kcmil CU-AL or (2) 1/0-250 AL or (2) 1/0-3/0 CU			
600	5	WP6511RJB	40.00	40.00							
225	400	2	WP4212RJB	QP, QPH, HQP, MP-T, MP-HT, MP-MT, QS, QSH, QSHH, HQS, HQSH	100,000	29.75	28.53	7.56	INCL. - 9:00 factory, 6:00 field	ECMFH	1/0-750 kcmil CU-AL or (2) 1/0-250 AL or (2) 1/0-3/0 CU
		3	WP4312RJB			38.75					
		4	WP4412RJB			47.75					
	600	5	WP6412RJB			29.59	46.22				(2) #2-600 kcmil
		6	WP6512RJB			38.75					
	800	6	WP8612RJB				51.03				(2) 1/0-750 kcmil or (4) 1/0-250 AL or (4) 1/0-3/0 CU
1000	6	WP10612RJB	(3) #2-500 kcmil								

Horn Bypass, Alternate Enclosure Size & Lug Configuration^②

125	200	2	WPC2211RJB	QP, QPH, HQP, MP-T, MP-HT, MP-MT	65,000	32.53	13.80	5.81	INCL. - 9:00 factory, 6:00 field	#6-300 kcmil
225	400	2	WPC4212RJB	QP, QPH, HQP, MP-T, MP-HT, MP-MT, QS, QSH, QSHH, HQS, HQSH	100,000	29.75	28.53	7.56		#6-350 kcmil
225	400	3	WPC4312RJB	100,000	38.75					

① Dimensions shown are representative of outside box dimensions and do not include allowances for mounting bumps, endwalls, covers, hubs, or hardware protrusions. Dimensions are subject to change.
 ② These units are for specific utilities only. Please contact sales office for more information.

Uni-PAK: Type WEP Ring Style EUSERC Compliant

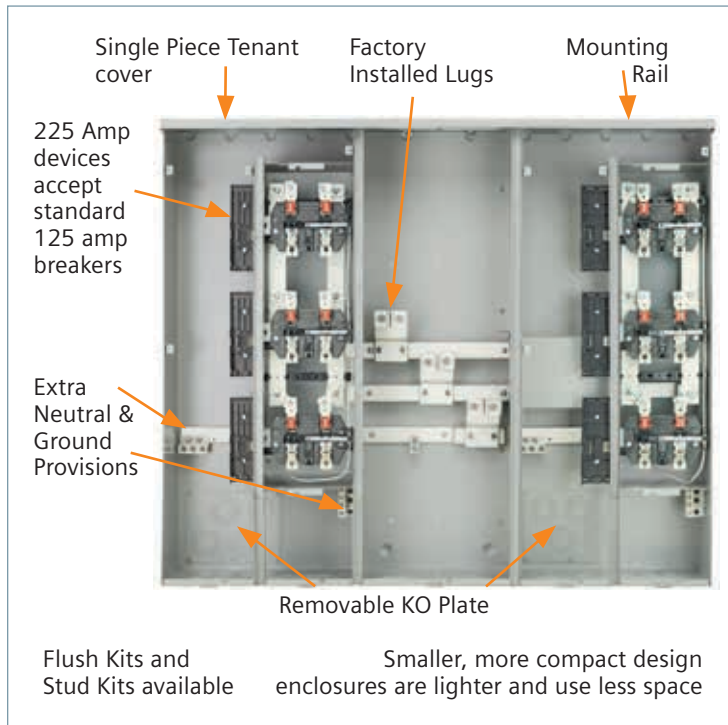

Features

- Individual split ring style covers
- UL Listed for 60 / 75°C conductors. See equipment markings for applications
- For small apartment buildings, small professional and commercial buildings
- Completely self-contained meter centers
- Two to six 125A and 225A breaker positions
- Outdoor surface mounted enclosures
- Semi flush with applicable field installed kit
- Compact, pre-bussed, easy to handle, hang and wire
- Barrired, sealable compartment for unmetered current-carrying parts
- Al/Cu lay-in lugs, except two socket units
- Top or bottom feed
- Bottom and rear branch wiring exits (Neutral and ground at bottom only)
- ANSI #61 light gray electrodeposited paint on zinc-coated G90 steel
- Meets EUSERC specifications when NEMA stud kit (if required) is field added. Compression lugs, if required, are sold separately.

Uni-PAK: Type WEP Ring Style EUSERC Compliant

Ring Style Uni-PAK 120/240V 1 Phase, 3 Wire EUSERC Compliant

Max. Tenant Main	Bus Amperage	Meter Positions Per Pak	Catalog Number	Breaker Provision	Max. AIC	Dimensions ^①			5th Jaw Assembly	Line Lugs Wire Range	Semi-Flush Kit #	EUSERC Drawing #342 ^②
						Height	Width	Depth				
125	200	2	WEP2211	QP, QPH, HQP, MP-T, MP-HT, MP-MT	65,000	32.52	13.80	7.56	ECMF5 6:00 or 9:00	#6-300 kcmil	WPFK1	Figure 1
	300	3	WEP3311			38.75	25.42			#2-600 kcmil	WPFK2	Figure 3
	400	4	WEP4411			47.75				1/0-750 kcmil CU-AL or (2) 1/0-250 AL or (2) 1/0-3/0 CU	WPFK3	Figure 3
		5	WEP4511			38.75					WPFK4	Figure 3
	500	4	WEP5411			47.75	38.94			(2) #2-600 kcmil	WPFK12	Figure 3
	400	6	WEP4611			31.28	WPFK5				Figure 3	
	600	5	WEP6511			38.75	44.82				Figure 3	
225	400	2	WEP4212	QP, QPH, HQP, MP-T, MP-HT, MP-MT, QS, QSH, QSHH, HQS, HQSH	100,000	29.75	28.53	7.56	ECMF5 6:00 or 9:00	1/0-750 kcmil CU-AL or (2) 1/0-250 AL or (2) 1/0- 3/0 CU	WPFK6	Figure 2
		3	WEP4312			38.75					WPFK7	Figure 3
	600	4	WEP4412			47.75	34.41			(2) #2-600 kcmil	WPFK8	Figure 3
		5	WEP6412			38.75	51.04				WPFK9	Figure 3
		6	WEP6512								WPFK10	Figure 3
	800	6	WEP6612			38.75	51.04			(2) 1/0-750 kcmil or (4) 1/0-250 AL or (4) 1/0- 3/0 CU	WPFK13	N/A
			WEP8612 ^②								(3) #2-500 kcmil	WPFK11
1000		WEP10612 ^②	57.53									

NEMA Stud Kits

Catalog Number	Ameperage	Note
WPSK400	400A	Fits 300-400
WPSK600	600A	Fits 500-600
WPSK800	800A	
WPSK1000	1000A	

① Dimensions shown are representative of outside box dimensions and do not include allowances for mounting bumps, endwalls, covers, hubs, or hardware protrusions. Dimensions are subject to change.

② Please note the EUSERC standard currently only covers up to 600amp devices. Please consult utility prior to installation.

Uni-PAK: Type WPL Ringless Style, Lever Bypass

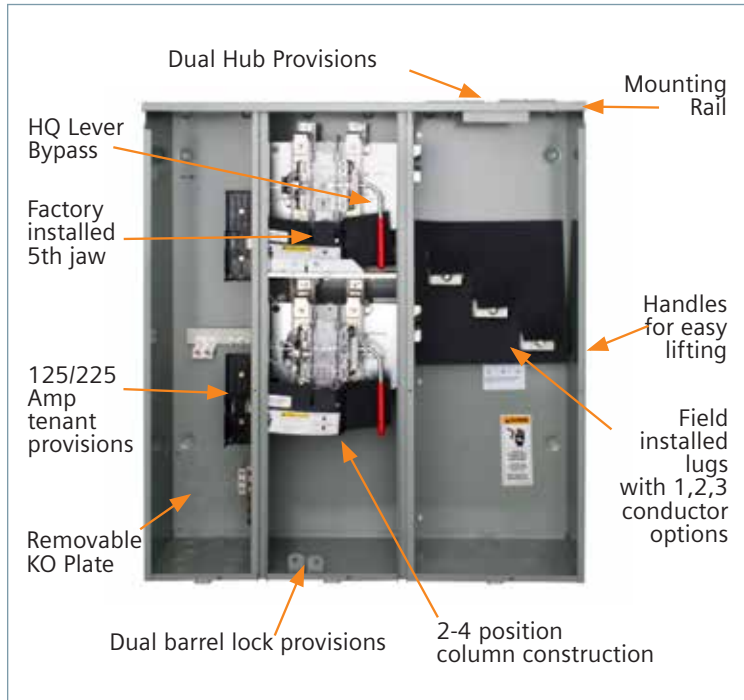

Features:

- Side mounted handles to help in lifting
- Provisions for one, two, or three incoming conductors per phase and neutral (lugs field installed)
- 225 amp branch tenant provisions @ 100,000 AIC
- Full line of 2–6 position devices
- Light and compact design
- Individual split ringless style covers
- UL Listed for 60 / 75 degrees C conductors. See equipment markings for applications
- For small apartment buildings, small professional and commercial buildings
- Completely self-contained meter centers
- Outdoor surface mounted enclosures
- Barriercd, sealable compartment for unmetered current-carrying parts
- Top or bottom fed
- Bottom and rear branch wiring exits (Neutral and ground at bottom only)
- ANSI #61 light gray electrodeposited paint on zinc-coated G90 steel

Uni-PAK: Type WPL Ringless Style, Lever Bypass

Ringless Style Uni-PAK 120/240V 1 Phase, 3 Wire, Lever Bypass

Max. Tenant Main	Bus Amperage	Meter Positions Per Pak	Catalog Number	Breaker Provision	Max. AIC	Dimensions ^①			5th Jaw Assembly	Line Lugs Wire Range
						Height	Width	Depth		
225	400	2	WPL4212RJ	QP, QPH, HQP, MP-T, MP-HT, MP-MT, QS, QSH, QSHH, HQS, HQSH	100,000	36.88	33.72	9.84	INCL.-9:00 position	3/8" Stud – Field installed lugs ^②
		3	WPL4312RJ			49.88				
		4	WPL4412RJ WPL6412RJ			62.88				
	600	5	WPL6512RJ WPL6612RJ			49.75	53.56			
		6	WPL8612RJ				57.81			
			WPL10612RJ							

Lug Kits^②

Catalog Number	Wire Range
H56476	3/0 - 800 kcmil
H60162	(2) 1/0-250 kcmil OR (1) #4-600 kcmil
H68752-1	(3) #6-250 kcmil
H56732-2	(2) #4-350 kcmil
H56732-M	(2) #4-500 kcmil

^① Dimensions shown are representative of outside box length, width, and depth and do not include allowances for mounting bumps, endwalls, covers, hubs or hardware protrusions. Dimensions are subject to change.

^② Lug kits should be chosen based on the wire size being run to the unit. Wire should be sized according to the National Electrical Code. Lugs are sold individually. A total of 3 lugs are required to wire the line side of the device. Lugs sold in packs of 2 pieces.

Power Mod and Uni-PAK

Multifamily Metering Accessories & Replacement Parts

Siemens offers a wide range of accessories and custom options to help product fit your application. Eliminate the need for special orders with replacement part kits available for your convenience. All kits come with appropriate hardware and instruction sheets for installation.

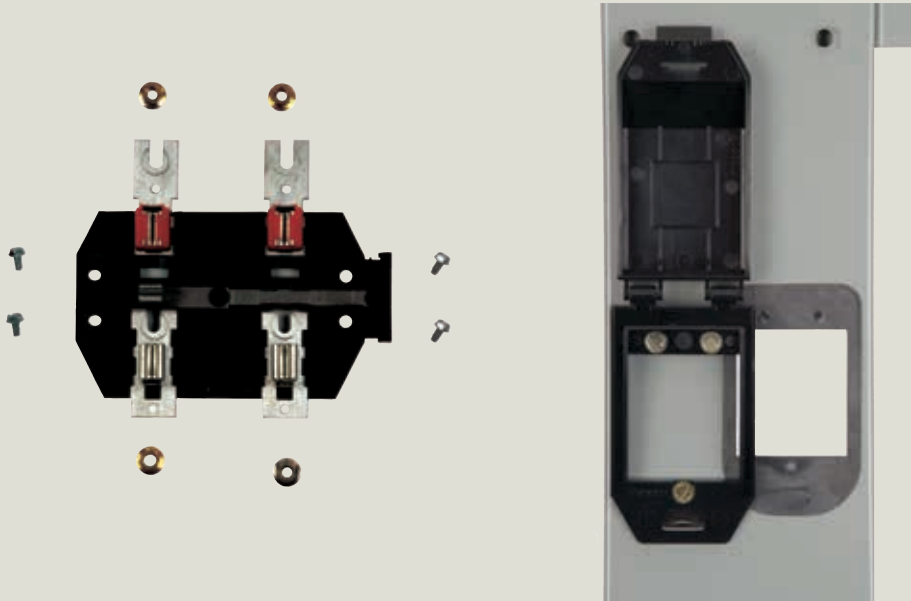













Uni-PAK & Power Mod: Accessories & Replacement Parts

Uni-PAK Lug Kits

Catalog Number	Description
Mechanical Lugs for NEMA Stud Kits	
SUK350TA	(2) #6-350 kcmil
SUK600TA	(1) #2-600 kcmil
SUK1000TA	(2) 500-1000 kcmil
Uni-PAK NEMA Stud Kits (WEP ONLY)^②	
WPSK400	Fits 300 - 400A
WPSK600	Fits 500 - 600A
WPSK800	800A
WPSK1000	1000A
Uni-PAK Alternate Lug Kits (WP ONLY)	
WPLK2400	400A Bus Lug Kit (2) #4-250
WPLK2600	600A Bus Lug Kit (3) #6-250

Conduit Hubs

Catalog Number	Description
Type RX	
EC38594	3/4" Conduit Hub
EC38596	1" Conduit Hub
EC38597	1 1/4" Conduit Hub
EC38598	1 1/2" Conduit Hub
EC9747-1113	Adapter plate for HD/RX
Type HD	
EC56854 ^②	2" Conduit Hub
EC56855 ^②	2 1/2" Conduit Hub
EC56856	3" Conduit Hub
EC56857	3 1/2" Conduit Hub
EC56858	4" Conduit Hub
EC56933S	Closure Plate

Accessory	Catalog Number	Description
	QC1	QuickConnect 1-phase, 3-wire, 1200 Amp maximum
	QC4	QuickConnect 3-phase, 4-wire, 1200 Amp maximum
	LLP600	Lug Landing Pad for 200-600 Amp Standard Breaker modules (WB) only
	LLP1200	Lug Landing Pad for 800-1200 Amp Standard Breaker modules (WB) only
	WMMBK ^①	Pass-thru bussing - for use with underground pull box (WMMB modules)
	WMEP	Plastic end enclosure plate for thru bussing
	SRSS	Sealing ring - snap-on, stainless steel
	SRSW	Sealing ring - screw type, stainless steel
	SRSTD	Sealing ring - snap on, aluminum
	ECJS ^③	Meter bypass jumper 4 AND 5 JAW - not for use with lever bypass. For temporary use ONLY.
	ECPP	Plastic Ring Style cover plate
	ECCP3	Plastic Ringless Style cover plate















① One pass thru bussing supplied with each WMMB device.

② Item is a kit consisting of adapter plate and RX Type Hub











③ (2) Required per 1-phase meter socket. Residential type ring and ringless - 200 Amp max. Meter cannot be installed while in use. For use with ECPP cover plate.

④ No kits are available for WEP2211.

Uni-PAK & Power Mod: Accessories & Replacement Parts

	Catalog Number	Description
	ECMMRS	Power Mod mini ratchet set Includes: <ul style="list-style-type: none"> • 2" T-25 Torx Bit - Eases removal and re-installing of cover screws • 5/16" Magnetic Nut Setter - Eases the installation of Tap Boxes, when QuickBolt assembly is required from one side to the other. In addition, quickly install or reposition the 5th jaw. • 3/8" x 1/4" drive deep well socket - Eases connection of adjacent module using hardware provided.
	ECMFTAB	Mounting tabs or "ears" for top of Power Mod devices
	ECMFGN125	Ground/neutral Bar kit for 125 Amp type WMM Residential Stacks, ground only for 225 Amp type WMM Residential Stacks
	ECMFN225	Neutral bar kit for 225 Amp Residential stacks (type WMM Power Mod only)
	ECMFWLCLIP	Rail/clip located on back of unit with wheels (Power Mod only)
	ECMFPK	Power Mod loose parts replacement kit (parts shipped loose include labels and hardware, QuickConnect™ not included.)
	ECMMBCM	Power Mod plastic breaker cover for type WB & WEB main breaker units
	ECMMNKOP	Power Mod knock-out plate without knock-outs for Type WMM Residential Stacks
	ECMMKOP	Power Mod knock-out plate with knock-outs for type WMM Residential Stacks
	MMRAIL	12" Standard wall mounting rail (Power Mod only)
	MMCLIP	Rail/clip that comes on back of unit (no wheels) (Power Mod only)
	MMZR24	24" long mounting "Z" rail for wall mounting (Power Mod only)
	MMZR36	36" long mounting "Z" rail for wall mounting (Power Mod only)
	MMZR48	48" long mounting "Z" rail for wall mounting (Power Mod only)
	MMZR60	60" long mounting "Z" rail for wall mounting (Power Mod only)

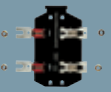
Uni-PAK & Power Mod: Accessories & Replacement Parts

	Catalog Number	Description
	ECMFH	Horn bypass kit for field replacement or addition on <u>ringless</u> type WMM meter stacks and <u>ringless</u> series WP & WPC Uni-PAK.
	ECMF5	5th jaw replacement for Power Mod type WMM meter stacks & Series WP, WEP, & WPC Uni-PAK.
	ECMF5	Meter Socket replacement for Power Mod type WMM meter stacks & Series WP, WEP, & WPC Uni-PAK.
	ECMFBM1	Breaker mounting replacement for 125 Amp Power Mod Type WMM, WML, WMT 1 Phase Meter Stacks & Series WP, WEP, WPL & WPC Uni-PAK.
	ECMFBM2	Breaker Mounting replacement for 225 Amp Power Mod Type WMM, WML, WMT 1 Phase Meter Stacks & Series WP, WEP, WPL & WPC Uni-PAK.
	ECMFMC	Ring type Meter cover replacement for Power Mod Type WMM Ringstyle Residential Meter stacks & WP, WEP, & WPC Series Ring style Uni-PAK.
	ECMFMC	Ringless Meter cover replacement for Power Mod Type WMM Ringless Residential Meter stacks & WP & WPC Series ringless Uni-PAK.
	ECMMRLCK	Power Mod Uni-PAK ring to ringless cover conversion kit for Type WMM Meter stacks & WP Series Uni-PAK.
	ECMMRCK	Power Mod Uni-PAK ringless to ring cover conversion kit for Type WMM Meter stacks & WP Series Uni-PAK
	ECMFCS	Cover screw replacement (quantity 10) for Power Mod & Uni-PAK devices.
	ECMFPS	Quick phase "Z" strap replacement for Power Mod Type WMM Meter stacks & Series WP, WEP, & WPC Uni-PAK.
	ECBC	Breaker cover replacement for Type WMM, WML, WMT 1 Phase Meter stacks & Series WP, WEP, WPL, & WPC Uni-PAK.

Uni-PAK & Power Mod: Tenant Circuit Breakers



QP - 2 Poles



QP - 3 Poles



QS



QR

Amperage	10K AIC	22K AIC	42K AIC	65K AIC	100K AIC
	Type QP	Type QPH	Type QPHH	Type QPHH	Type HQSH

For Use In 125 Amp and 225[®] Amp Single-Phase Output WMM, WML, WMT, WP, WPC, WEP, WPL Metering^④

60	Q260	Q260H	Q260HH	Q260HH	-
70	Q270	Q270H	Q270HH	Q270HH	-
80	Q280	Q280H	Q280HH	Q280HH	-
90	Q290	Q290H	Q290HH	Q290HH	-
100	Q100	Q100H	Q100HH	Q100HH	HQS2100H ^①
110	Q110	Q110H	Q110HH	Q110HH	HQS2110H ^①
125	Q125	Q125H	Q125HH	Q125HH	HQS2125H ^①

For Use In 100 Amp, Three-Phase Output WML Meter Stacks Only

60	Q360	Q360H	Q360HH	Q360HH	-
70	Q370	Q370H	Q370HH	Q370HH	-
80	Q380	Q380H	Q380HH	Q380HH	-
90	Q390	Q390H	Q390HH	Q390HH	-
100	Q3100	Q3100H	Q3100HH	Q3100HH	-

For Use In 225[®] Amp Single-Phase Output WMM, WML, WMT, WP, WPC, WEP, WPL Metering^④

	Type QS ^②	Type QSH ^③	Type QSHH ^③	Type HQS ^③	Type HQSH ^③
100	QS2100	QS2100H	QSH2100	QS2100HH	HQS2100H
125	QS2125	QS2125H	QSH2125	QS2125HH	HQS2125H
150	QS2150	QS2150H	QSH2150	QS2150HH	HQS2150H
175	QS2175	QS2175H	QSH2175	QS2175HH	HQS2175H
200	QS2200	QS2200H	QSH2200	QS2200HH	HQS2200H
225	QS2225	QS2225H	QSH2225	QS2225HH	HQS2225H

For Use In 225 Amp, Three-Phase Output WML & WMT Meter Stacks Only

	Type QR	Type QRH		Type HQR	Type HQRH
100	QR23B0100	QRH23B0100	-	HQR23B0100	HQR23B0100H
110	QR23B0110	QRH23B0110	-	HQR23B0110	HQR23B0110H
125	QR23B0125	QRH23B0125	-	HQR23B0125	HQR23B0125H
150	QR23B0150	QRH23B0150	-	HQR23B0150	HQR23B0150H
175	QR23B0175	QRH23B0175	-	HQR23B0175	HQR23B0175H
200	QR23B0200	QRH23B0200	-	HQR23B0200	HQR23B0200H
225	QR23B0225	QRH23B0225	-	HQR23B0225	-

① HQSH breakers require the use of 225 Amp WMM meter stacks or 225 Amp per position Uni-PAK metering.

② QP Breakers will fit in 225A WMM, WML, & WMT meter stacks.

③ QS breakers series rates with Murray circuit breakers.

④ QR breakers available March 2016. For QJ breaker selection ask Customer Support.

Notes:

Siemens Industry, Inc.
5400 Triangle Parkway
Norcross, GA 30092

1-800-241-4453
info.us@siemens.com

Subject to change without prior notice
Order No. RPSA-MULTI-0116
Printed in USA
All rights reserved
© 2016 Siemens Industry, Inc.

Subject to changes and errors. The information given in this document only contains general descriptions and/or performance features which may not always specifically reflect those described, or which may undergo modification in the course of further development of the products. The requested performance features are binding only when they are expressly agreed upon in the concluded contract.

www.usa.siemens.com/powermod