

- Built-in LED Driver
- Universal Voltage: 120-277VAC, 50/60Hz
- Output Power: 60W Max.
- Output Current: 500-2100mA
- Output voltage range of 10-57 VDC
- Long Case
- IP65 Dry and Damp
- Suitable for Class I luminaire
- U-OUT 60 V

This Driver Will Operate The Following LED Modules: Any LED module designed to accept input voltage range of 10- 57 VDC and can operate up to current of 5002100 mA.

General Specifications

Input Voltage	120-277V~, 50/60 Hz
Input Current	0.6A Max
Input Power	72W
Power Factor	>0.95
THD	<20%
Efficiency	89% Typical@277V Full Load
Driver Type	Constant Current
Output Current	500-2100mA Programmable; See Label for Set Current; To Program Use R-SET (Figure 1) or TPSB100 (Programmer); Record New Setting On 1" x 0.5" Label
Output Voltage Range	10-57V=
Output Power	60W Max.
Number of Output Channels	1 Channel
Dimming Controller Type/Dimming Range	0-10VDC / 100%-1%, 0% (Figure 1)
RFI/EMI	FCC Part 15B Consumer, EN55015
Output Type	LED Class 2
Potting Type / Degree of Fill	Potting As Per ASTM D36-86 / Fully Potted
Ambient Operating Temperature Range	-40°C to 60°C (-40°F to 140°F)
Max. Case Temperature	90°C (194°F)
Sound Rating	A
Input Surge Protection	Line-Neutral 4kV, Line & Neutral-Ground 6kV
Protections	Input Current Protection
	Output Short Circuit Protection
	Output Open Circuit Protection
	Output to Ground Short Protection
	Overload Protection
Service Life	Over Temperature Protection
	50,000 hours @Tc 80°C (176°F)
Approvals / Class	LED Class 2, UL Listed, Class P, Type HL, Dry or Damp Locations
Warranty	5 years

Figure 1

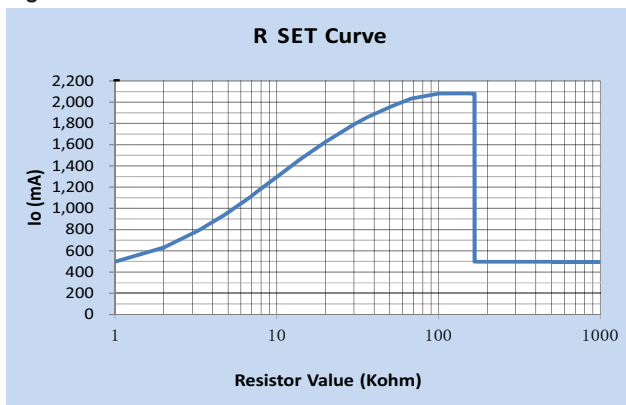
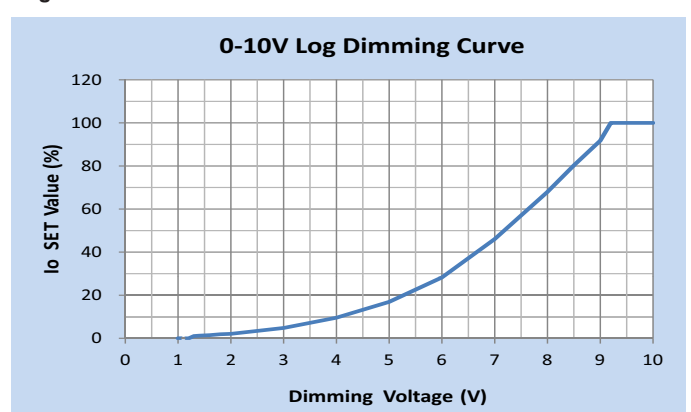

Figure 2



Fulham extends a limited warranty to the original purchaser or first user for a period of 5 years from the date of manufacture when properly installed and operated under normal conditions of use. The usage of appropriate series connected Surge Protection Device (SPD) is required in high risk applications. For complete terms and conditions, please refer to the Warranty Center at www.fulham.com. Specifications subject to change without notice.

Figure 3

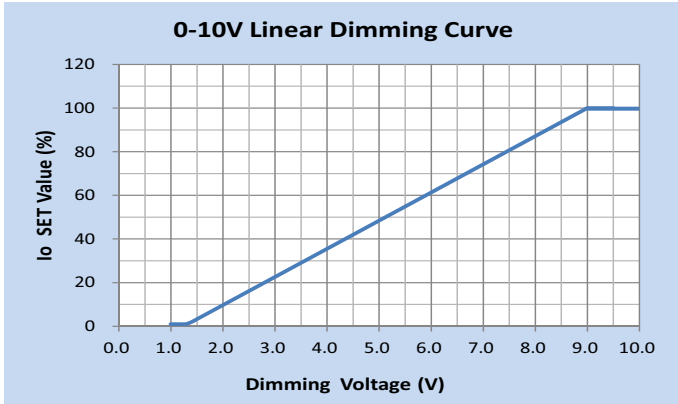

Figure 4

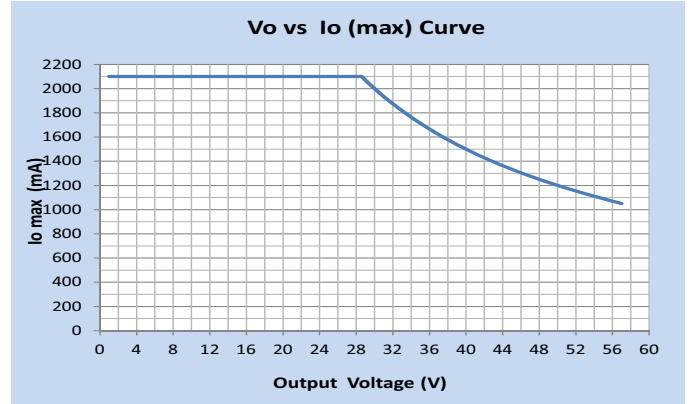

Figure 5

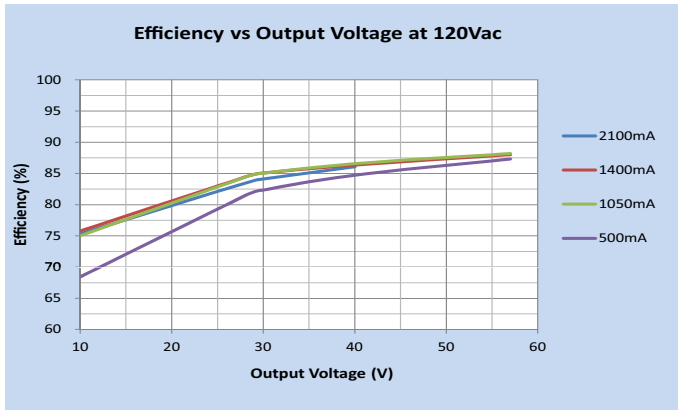

Figure 6

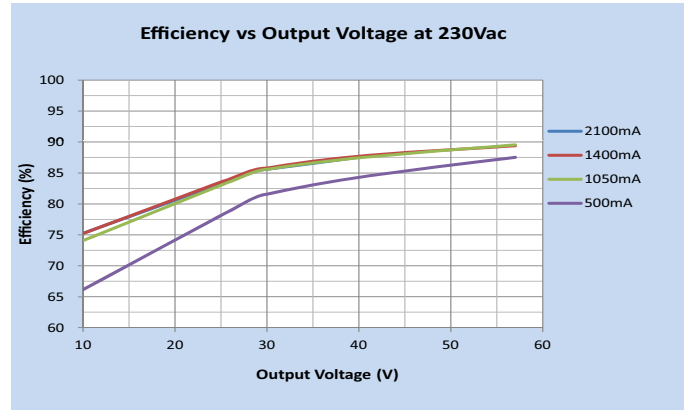

Figure 7

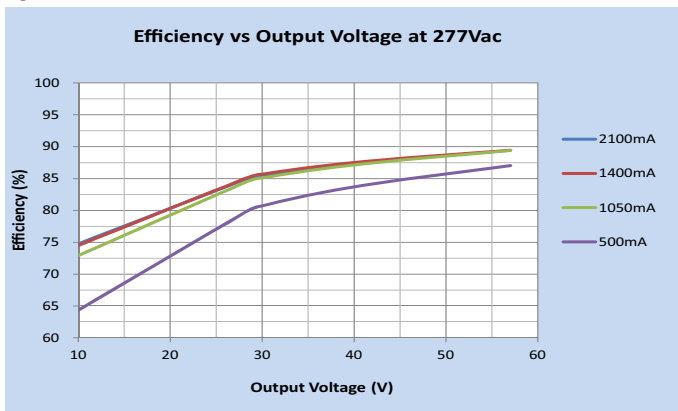
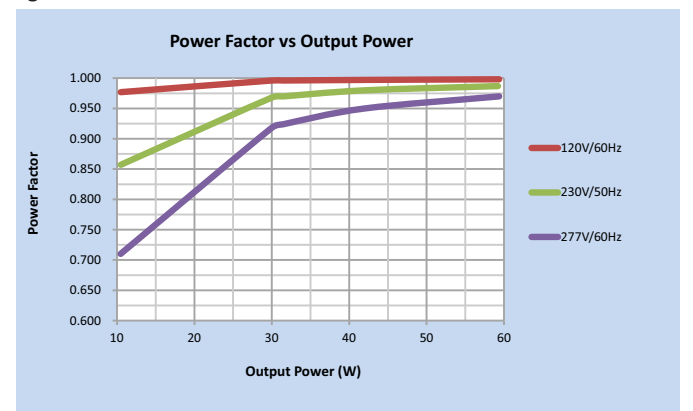

Figure 8



Fulham extends a limited warranty to the original purchaser or first user for a period of 5 years from the date of manufacture when properly installed and operated under normal conditions of use. The usage of appropriate series connected Surge Protection Device (SPD) is required in high risk applications. For complete terms and conditions, please refer to the Warranty Center at www.fulham.com. Specifications subject to change without notice.

Figure 9

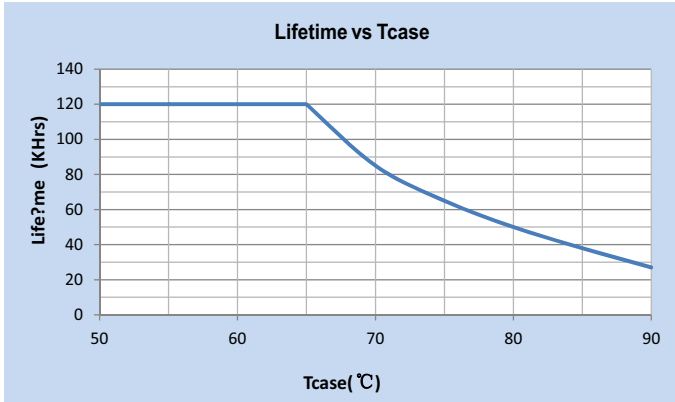

Figure 10

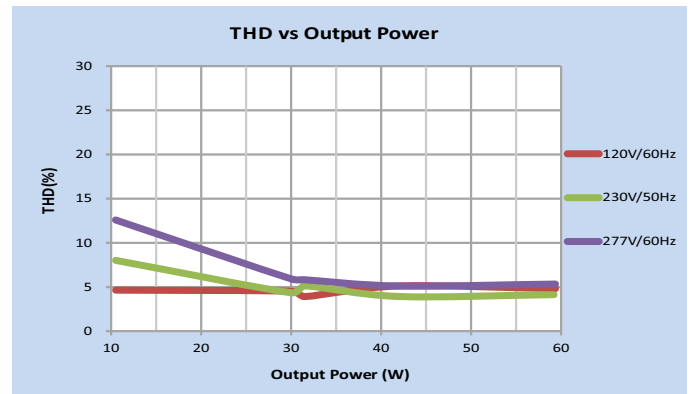

Figure 11

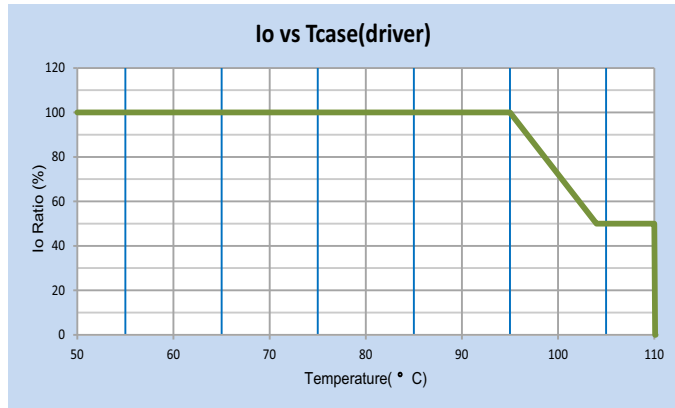
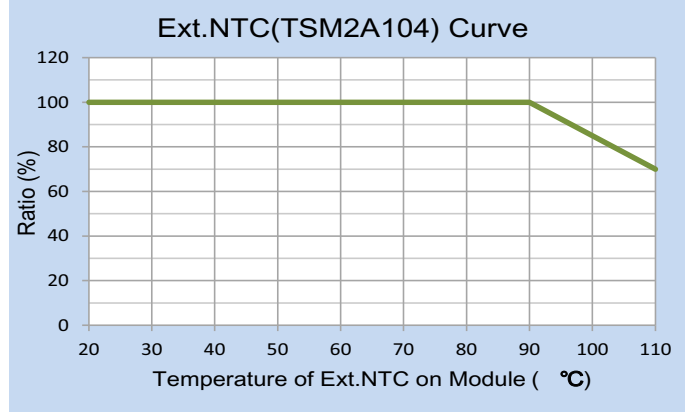

Figure 12



Mechanical Data

NOTE :

- 1.This Driver Must Be Installed By A Licensed Electrician
- 2.This Driver Must Be Grounded

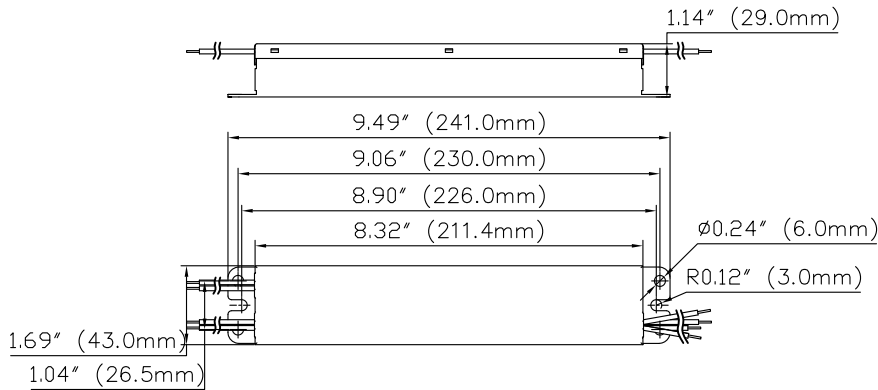

Fulham extends a limited warranty to the original purchaser or first user for a period of 5 years from the date of manufacture when properly installed and operated under normal conditions of use. The usage of appropriate series connected Surge Protection Device (SPD) is required in high risk applications. For complete terms and conditions, please refer to the Warranty Center at www.fulham.com. Specifications subject to change without notice.

Wiring Diagrams

INPUTSIDE	LENGTH
WHITE	330mm[13"]
BLACK	330mm[13"]
PURPLE	330mm[13"]
GRAY	330mm[13"]

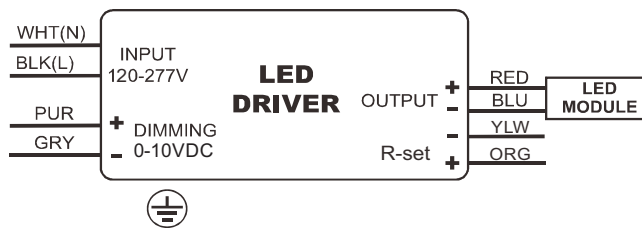

OUTPUTSIDE	LENGTH
RED	330mm[13"]
BLUE	330mm[13"]
YELLOW	250mm[9.84"]
ORANGE	250mm[9.84"]

Ø0.75mm²

AWG 18

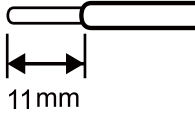

TPSB-100 Programming Controller

Please consult the user manual for instructions on using the TPSB-100 SmartSet programming controller



Fulham extends a limited warranty to the original purchaser or first user for a period of 5 years from the date of manufacture when properly installed and operated under normal conditions of use. The usage of appropriate series connected Surge Protection Device (SPD) is required in high risk applications. For complete terms and conditions, please refer to the Warranty Center at www.fulham.com. Specifications subject to change without notice.