



Model: _____ Item #: _____ Date: _____
 Project: _____ Qty: _____ Approved By: _____

12" Wide Space Saver Hand Sinks

HAND SINKS

Product Images

<p>HS-9L 12" Wide Hand Sink</p> 	<p>HS-9-LS/RS Side Splash on one side</p>  <p>HS-9-RS shown</p>	<p>HS-9-LF Faucet Not Included</p> 
<p>HS-21 w/ Heavy Duty Faucet</p> 	<p>HS-30L Side Splashes</p> 	<p>HS-35 Eyewash Station</p> 
<p>HS-31 Soap & Towel Dispenser</p> 	<p>HS-32 Soap & Towel Dispenser w/ Side Splashes</p> 	<p>HS-37 Soap & Towel Dispenser w/ Stainless Steel Skirt</p> 

Standard Features

Fabrication	20 gauge stainless steel
Bowl	9-3/4"W x 12-1/2"L x 6" Deep drawn bowl with stamped rim to prevent spillage
Wall Mount Bracket	Offset design for added strength
Faucet	4" center wall mount faucet included on most models
Drain	Stainless steel
Drain with Overflow	Stainless Steel with plastic overflow tube and inlet
Plumbing	1/2" IPS hot and cold water. 1-1/2" IPS drain outlet. Install at 36" working height. 1/2" faucet supply 12" from floor. 1-1/2" drain line 23-1/4" from floor.
Lead Free	Products are certified to NSF/ANSI 61 and 372 and conforms with the lead content requirements for lead free plumbing as defined by the U.S. Safe Drinking Water Act.

Optional Accessories

21-311L	Wrist Blade Handle Kit
H-100	Chrome Plated 1-1/2" IPS P-Trap
H-104	Wall Mount Soap Dispenser
H-105	Wall Mount Towel Dispenser
H-106L	Left Side Splash
H-106R	Right Side Splash
H-107	Left and Right Side Splashes
H-108	Stainless Steel Skirt
H-109	Upgrade: Royal Series Faucet
H-110	Side Support Brackets
H-111	Soap & Tow



Certified to NSF/ANSI 61-G



Model: _____ Item #: _____ Date: _____

Project: _____ Qty: _____ Approved By: _____

12" Wide Space Saver Hand Sinks

HAND SINKS

HS-9L or HS-9-LS/RS

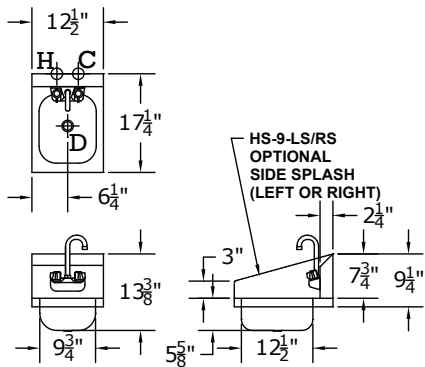

HS-9-LF

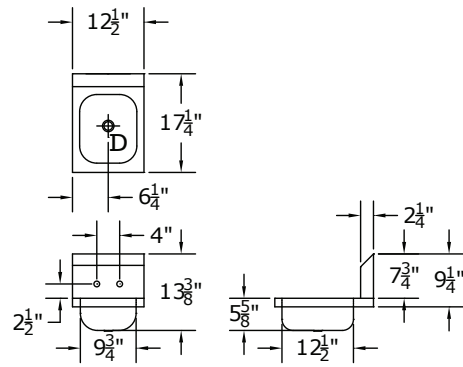

HS-21

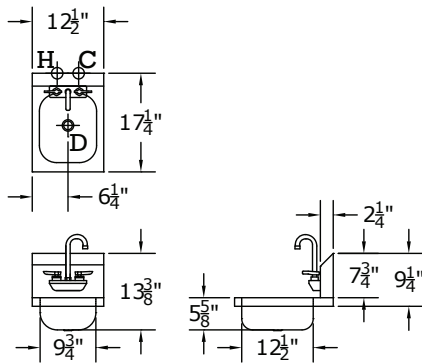

HS-30L

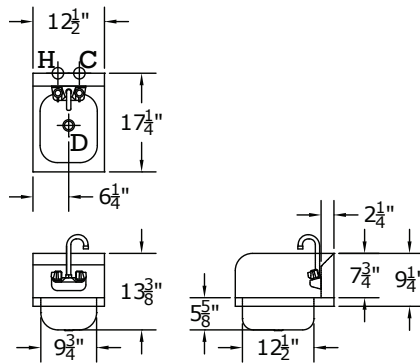

HS-35

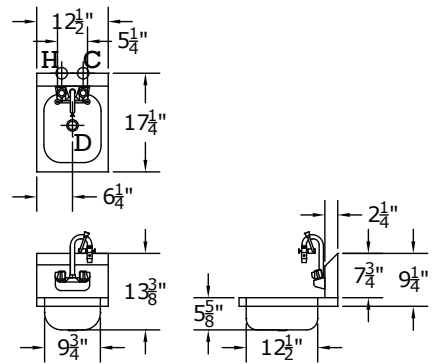

HS-31

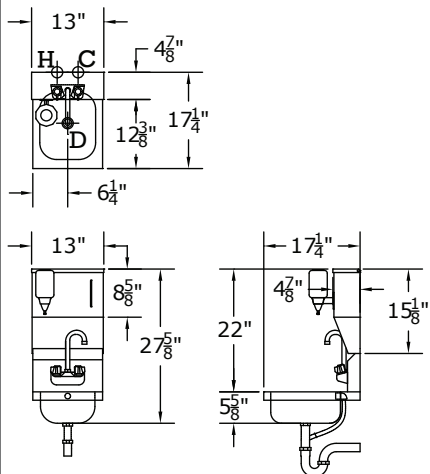

HS-32

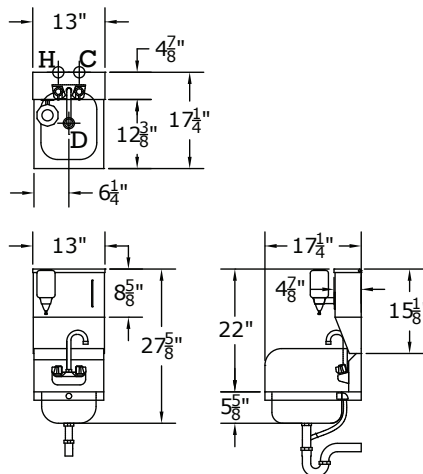

HS-37

