

# SeeSnake® Compact<sup>2</sup>



## **WARNING!**

Read this manual carefully before using this tool. Failure to understand and follow the contents of this manual may result in electrical shock, fire, and/or serious injury.

Visit [www.youtube.com/seesnake](http://www.youtube.com/seesnake) to watch instructional videos.

### SeeSnake® Compact<sup>2</sup>

Serial  
No.

# Table of Contents

## Introduction

Regulatory Statements ..... 3  
 Safety Symbols ..... 3

## General Safety Rules

Work Area Safety ..... 4  
 Electrical Safety ..... 4  
 Personal Safety ..... 4  
 Equipment Use and Care ..... 5

## Pre-Operation Inspection

### Specific Safety Information

SeeSnake Compact2 Safety ..... 6

## Product Overview

Description ..... 7  
 Specifications ..... 8  
 Standard Equipment ..... 8  
 System Components ..... 8

## Operating Instructions

Placement ..... 10  
 Routing the Camera ..... 10  
 Connecting to a SeeSnake Monitor ..... 11  
 Inspection Overview ..... 12  
 Best Practices ..... 13  
 Pipe Guides ..... 14  
 Locating the Sonde ..... 15  
 Line Tracing the Push Cable ..... 16  
 Retrieving the Camera ..... 16

## Individual Components

Self-Leveling Camera ..... 17  
 System Cable Assembly ..... 17  
 Docking System ..... 18

## Maintenance and Support

Maintaining Components ..... 20  
 Cleaning ..... 21  
 Accessories ..... 22  
 Transport and Storage ..... 22  
 Service and Repair ..... 22  
 Disposal ..... 22  
 Troubleshooting ..... 23

## Appendices

Appendix A: Docking Fin Removal ..... 24  
 Appendix B: Camera Fault Isolation ..... 24  
 Appendix C: Camera Removal ..... 25  
 Appendix D: Camera Installation ..... 26

## Introduction

The warnings, cautions, and instructions discussed in this manual cannot cover all possible conditions and situations that may occur. It must be understood by the operator that common sense and caution are factors which cannot be built into this product, but must be supplied by the operator.

## Regulatory Statements

**CE** The EC Declaration of Conformity (890-011-320.10) will accompany this manual as a separate booklet when required.

**FCC** This device complies with Part 15 of FCC rules. Operation is subject to the following two conditions: (1) This device may not cause harmful interference, and (2) this device must accept any interference received, including interference that may cause undesired operation.

## Safety Symbols

In this manual and on the product, safety symbols and signal words are used to communicate important safety information. This section is provided to improve understanding of these signal words and symbols.



This is the safety alert symbol. It is used to alert you to potential injury hazards. Obey all safety messages that follow this symbol to avoid possible injury or death.

### **⚠ DANGER**

DANGER indicates a hazardous situation which, if not avoided, will result in death or serious injury.

### **⚠ WARNING**

WARNING indicates a hazardous situation which, if not avoided, could result in death or serious injury.

### **⚠ CAUTION**

CAUTION indicates a hazardous situation which, if not avoided, could result in minor or moderate injury.

**NOTICE** NOTICE indicates information that relates to the protection of property.



This symbol means read the operator's manual carefully before using the equipment. The manual contains important information on the safe and proper operation of the equipment.



This symbol means always wear safety glasses with side shields or goggles when handling or using this equipment to reduce the risk of eye injury.



This symbol indicates the risk of electrical shock.

## General Safety Rules

### ⚠ WARNING



Read all safety warnings and instructions. Failure to follow the warnings and instructions may result in electrical shock, fire, and/or serious injury.

### SAVE THESE INSTRUCTIONS!

### Work Area Safety

- **Keep your work area clean and well lit.** Cluttered or dark areas invite accidents.
- **Do not operate equipment in explosive atmospheres, such as in the presence of flammable liquids, gases, or dust.** Equipment can create sparks which may ignite the dust or fumes.
- **Keep children and bystanders away while operating equipment.** Distractions can cause you to lose control.
- **Avoid traffic.** Pay attention to moving vehicles when using on or near roadways. Wear high-visibility clothing or reflector vests.

### Electrical Safety

- **Avoid body contact with earthed or grounded surfaces such as pipes, radiators, ranges, and refrigerators.** There is an increased risk of electrical shock if your body is earthed or grounded.
- **Do not expose equipment to rain or wet conditions.** Water entering equipment will increase the risk of electrical shock.
- **Keep all electrical connections dry and off the ground.** Touching equipment or plugs with wet hands can increase the risk of electrical shock.
- **Do not abuse the cord.** Never use the cord for carrying, pulling, or unplugging the power tool. Keep cord away from heat, oil, sharp edges, and moving parts. Damaged or entangled cords increase the risk of electrical shock.
- **If operating equipment that is powered by an AC adapter in a damp location is unavoidable, use a ground fault circuit interrupter (GFCI) protected supply.** Use of a GFCI with an AC adapter reduces the risk of electrical shock.

## Personal Safety

- **Stay alert, watch what you are doing, and use common sense when operating equipment.** Do not use equipment while you are tired or under the influence of drugs, alcohol, or medication. A moment of inattention while operating equipment may result in serious injury.
- **Dress properly.** Do not wear loose clothing or jewelry. Loose clothes, jewelry, and long hair can be caught in moving parts.
- **Practice good hygiene.** Use hot, soapy water to wash hands and other body parts exposed to drain contents after handling or using drain inspection equipment. To prevent contamination from toxic or infectious material, do not eat or smoke while operating or handling drain inspection equipment.
- **Always use appropriate personal protective equipment when handling and using equipment in drains.** Drains may contain chemicals, bacteria, and other substances that may be toxic, infectious, and cause burns or other issues. Appropriate personal protective equipment always includes safety glasses and may include a dust mask, hard hat, hearing protection, drain cleaning gloves or mitts, latex or rubber gloves, face shields, goggles, protective clothing, respirators, and steel toed, non-skid footwear.
- **If using drain cleaning equipment and drain inspection equipment at the same time, wear RIDGID drain cleaning gloves.** Never grasp the rotating drain cleaning cable with anything else, including other gloves or a rag which can become wrapped around the cable and cause hand injuries. Only wear latex or rubber gloves underneath RIDGID drain cleaner gloves. Do not use damaged drain cleaning gloves.

## Equipment Use and Care

- **Do not force equipment.** Use the correct equipment for your application. The correct equipment does the job better and more safely.
- **Do not use equipment if the power switch does not turn it on and off.** Any equipment that cannot be controlled with the power switch is dangerous and must be repaired.
- **Disconnect the plug from the power source and/or the battery pack from the equipment before making adjustments, changing accessories, or storing.** Preventive safety measures reduce the risk of injury.
- **Store idle equipment out of the reach of children and do not allow persons unfamiliar with the equipment or these instructions to operate the equipment.** Equipment can be dangerous in the hands of untrained users.
- **Maintain equipment.** Check for misalignment or binding of moving parts, missing parts, breakage of parts, and any other condition that may affect the equipment's operation. If damaged, have the equipment repaired before use. Many accidents are caused by poorly maintained equipment.
- **Do not overreach.** Keep proper footing and balance at all times. This enables better control of the equipment in unexpected situations.
- **Use the equipment and accessories in accordance with these instructions; taking into account the working conditions and the work to be performed.** Use of the equipment for operations different from those intended can result in hazardous situations.
- **Use only accessories that are recommended by the manufacturer for your equipment.** Accessories that may be suitable for one piece of equipment may become hazardous when used with other equipment.
- **Keep handles dry, clean, and free from oil and grease.** Clean handles give better control of the equipment.

## Pre-Operation Inspection

### ⚠ WARNING



To reduce the risk of serious injury from electrical shock or other causes, and to prevent damage to your equipment, inspect all equipment and correct any problems before each use.

To inspect all equipment, follow these steps:

1. Power off your equipment.
2. Disconnect and inspect all cords, cables, and connectors for damage or modification.
3. Clean any dirt, oil, or other contamination from your equipment to ease inspection and to prevent it from slipping from your grip during transport or use.
4. Inspect your equipment for any broken, worn, missing, misaligned, or binding parts, or any other condition which might prevent safe, normal operation.
5. Refer to the instructions for all other equipment to inspect and make sure it is in good, usable condition.
6. Check your work area for the following:
  - Adequate lighting.
  - The presence of flammable liquids, vapors, or dust that may ignite. If present, do not work in area until sources have been identified and corrected. The equipment is not explosion proof. Electrical connections can cause sparks.
  - A clear, level, stable, and dry place for the operator. Do not use the equipment while standing in water.
7. Examine the job to be done and determine the correct equipment for the task.
8. Observe the work area and erect barriers as necessary to keep bystanders away.

## Specific Safety Information

### ⚠ WARNING



This section contains important safety information that is specific to the SeeSnake Compact2. Read these precautions carefully before using the equipment to reduce the risk of electrical shock, fire, and/or serious injury.

---

### SAVE ALL WARNINGS AND INSTRUCTIONS FOR FUTURE REFERENCE!

---

### SeeSnake Compact2 Safety

- Read and understand this manual, the digital reporting monitor's manual, and the instructions for any other equipment you are using before operating the equipment. Failure to follow all instruction may result in property damage and/or serious injury. Keep this manual with the equipment for future use.
  - Operating the equipment while in water increases the risk of electrical shock. Do not operate the Compact2 if operator or equipment are standing in water.
  - The digital reporting monitor's battery and other electrical equipment and connections are not waterproof. Do not expose the equipment to wet locations.
  - The equipment is not designed to provide high voltage protection and isolation. Do not use where a danger of high voltage contact is present.
  - To prevent damage to the Compact2 and to decrease the risk of injury, do not expose the Compact2 to mechanical shocks. Exposure to mechanical shocks can damage equipment and increase the risk of serious injury.
- Do not carry the Compact2 by the monitor's docking handle or its front handle when transporting the system long distances or under conditions where disengagement of the docking system would be hazardous. An unexpected disengagement of the docking system may result in property damage and/or injury.
  - Placing the Compact2 where the drum cannot spin freely may result in the push cable over-winding inside the drum. Over-winding the push cable may result in property damage and/or serious injury. During operation, place the Compact2 on a stable surface and make sure the drum can spin freely.

## Product Overview

### Description

The SeeSnake Compact2 camera reel offers fast, easy setup and can take on the most diverse and demanding inspection conditions. The Compact2 features a self-leveling camera at the end of a push cable stiff enough to give you the power to push through small or restricted pipes, yet flexible enough to make multiple tight turns.



The Compact2 has a 30 m [100 ft] long, friction-reducing push cable and a 25 mm [1 in] self-leveling camera designed to inspect pipes ranging from 38 mm to 152 mm [1.5 in to 6 in] in diameter, depending on pipe conditions. Once a point of interest has been found in the pipe, use the integrated 512 Hz sonde and a receiver to locate its position.

All SeeSnake monitors can connect to the Compact2 with the SeeSnake system cable. The SeeSnake CS6Pak is specifically designed to mount on the Compact2's docking system for viewing ease, quick setup, and effortless transport. You can retrofit the SeeSnake MiniPak to mount on the docking system with the Docking Handle Kit, sold separately.

The Compact2's unique docking system gives you ultra-fast setup. Tilt the CS6Pak to the desired viewing angle while docked or easily remove it from the dock for convenient placement in your work area.

The CS6Pak is a compact, portable digital reporting monitor that you can use to capture audio, video, and photos of your pipe inspections. When you use the CS6Pak with the Compact2, you can deliver a USB drive containing an automatically generated professional report of the inspection to your customer before leaving the premises.



Specifications	
<b>Weight</b>	8 kg [17 lb]
<b>Overall Dimensions</b>	
Length	625 mm [25 in]
Height	432 mm [17 in]
Width	360 mm [14 in]
<b>Drum Diameter</b>	432 mm [17 in]
<b>Camera</b>	
Type	Self-leveling
Length	38 mm [1.5 in]
Diameter	25 mm [1 in]
Light source	6 LEDs
Sonde	512 Hz
<b>Resolution</b>	
NTSC	656 × 492 pixels
PAL	768 × 576 pixels
<b>Spring Assembly</b>	
Type	Single
Length including camera	325 mm [12.8 in]
<b>Push Cable</b>	
Length	30 m [100 ft]
Diameter	6 mm [0.26 in]
Fiberglass core diameter	3 mm [0.14 in]
Minimum bend radius	63 mm [2.5 in]
<b>Pipe Capacity §</b>	38 mm to 152 mm [1.5 in to 6 in]
<b>System Cable Length</b>	3 m [10 ft]
<b>Operating Environment</b>	
Temperature ‡	-10°C to 50°C [14°F to 122°F]
Storage temperature	-10°C to 70°C [14°F to 158°F]
Ingress protection without monitor	IPx5
Relative humidity	5 to 95 percent
Altitude	4,000 m [13,120 ft]
§ Actual pipe capacity depends on pipe conditions.	
‡ While the camera can function in extreme temperatures, some image quality changes may occur.	

### Standard Equipment

- SeeSnake Compact2
- Docking System
- Operator’s Manual
- Product Video
- Pipe Guide Kit
- Spanner Wrench

### System Components





### Push Cable Guides

There are three push cable guides on the frame, one inner guide and two outer guides. When using the Compact2, the camera, spring, and push cable should be threaded through all three guides.

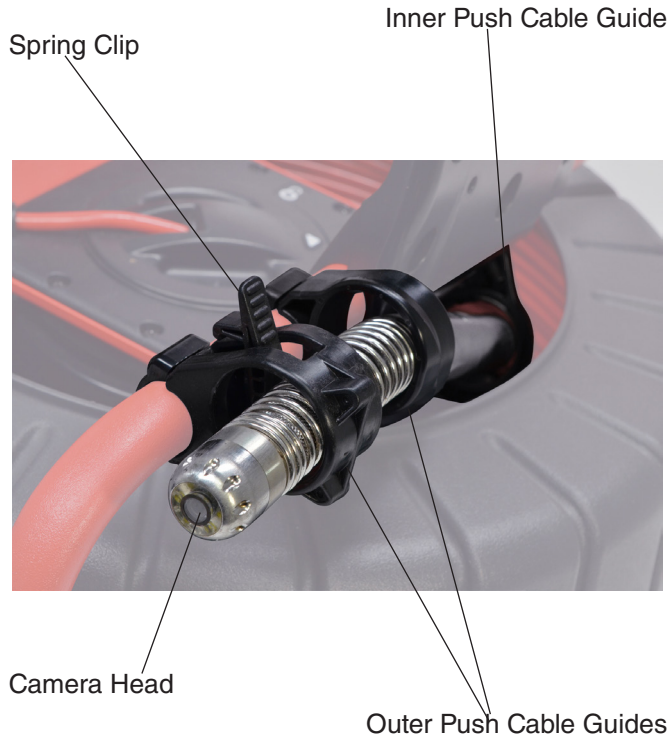

### Spring Clip

On the outermost push cable guide, press the tab toward the outer edge of the push guide to lock open the clip and free the camera spring. After the camera spring is released, return the spring clip to the operation position. In the operation position, the spring clip helps guide the push cable and secures the camera spring when it is pushed back through the cable guides preventing it from retracting back into the drum. The spring clip must be in the operation position during transport to prevent the camera spring from retracting back into the drum.

Operation Position



Locked Open

Only lock open the spring clip when you are routing the camera. Keep the spring clip in the operation position during normal use.

## Operating Instructions

**⚠ WARNING**



Wear appropriate protective equipment such as latex or rubber gloves, goggles, face shields, and respirators when inspecting drains that might contain hazardous chemicals or bacteria. Always wear eye protection to protect against dirt and other foreign objects.

Do not operate equipment if operator or equipment are standing in water. Operating the equipment while in water increases the risk of electrical shock. Rubber-soled, non-slip shoes can help prevent slipping and electrical shock on wet surfaces.

### Placement

Place the SeeSnake Compact2 and the CS6Pak near the pipe entrance so you can manipulate the push cable while viewing the display.

Placing the Compact2 where the drum cannot spin freely may result in the push cable over-winding inside the drum. Over-winding the push cable may result in property damage and/or serious injury. During operation, place the Compact2 in a stable location and make sure the drum can spin freely. Do not pull the push cable out of the drum unless the drum can spin freely.

## Routing the Camera

If the camera is inside the drum, you must route the camera through the push cable guides. The push cable and camera head should be threaded through all three guides.

1. Lock open the spring clip.
2. Reach inside the drum and find the camera.
3. Insert the camera through the inner push cable guide and then through the two outer push cable guides.



4. Return the spring clip to the operation position to secure the spring and prevent the push cable from retracting back into the drum.



## Docking System

The Compact2 comes with a docking system assembly installed so that a compatible monitor can be mounted onto the reel for easy transport. Tilt the docked monitor to the desired viewing angle or easily remove it from the dock for convenient placement in your work area. The docking system assembly is removable.

*Note: Refer to the Docking System section for instructions on how to mount and remove a compatible monitor.*

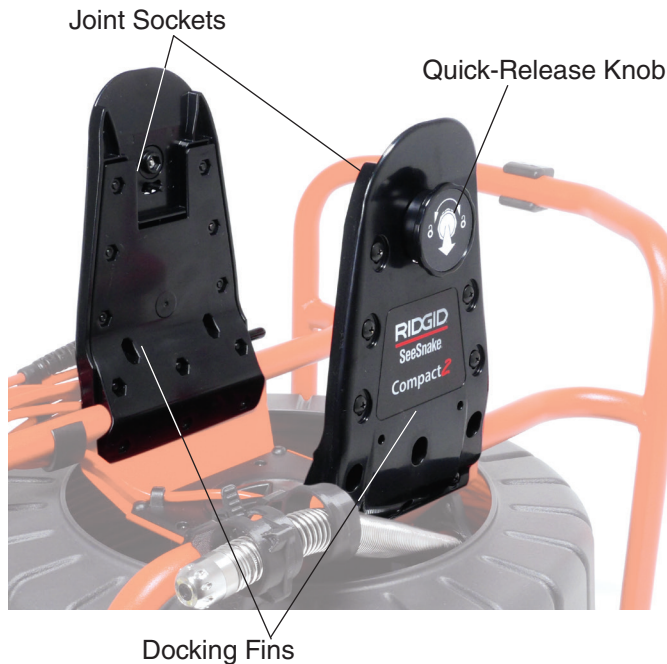



## Connecting to a SeeSnake Monitor

The Compact2 can connect to any SeeSnake monitor with the SeeSnake system cable.

1. Unwrap the system cable from the cable wraps.
2. Pull back the outer locking sleeve on the system cable connector.
3. Align the connector ridge and plastic guide pin with the socket and push the connector straight in.
4. Tighten the outer locking sleeve.

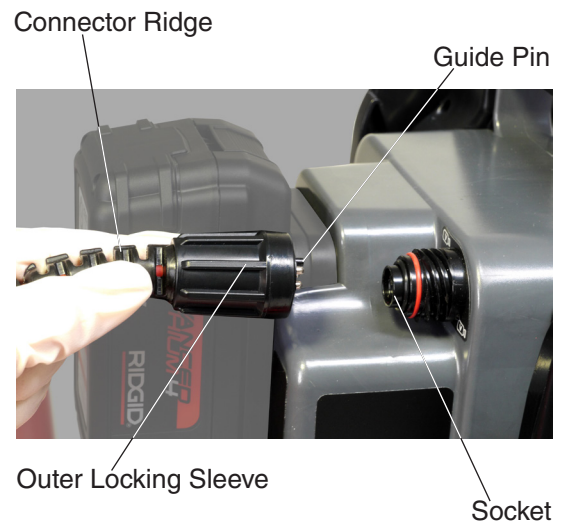
**NOTICE** Only twist the outer locking sleeve. To prevent damage to the pins, never bend or twist the connector.





5. Power on the system:
  - Press the Power key  to power on the system.
  - On a digital reporting monitor, press the Autolog key  to quick-start an inspection.

*Note: For some digital reporting monitors, a USB drive must be inserted to capture media. Refer to the monitor's manual for more information about the benefits of Autolog video recordings.*

## Inspection Overview





The SeeSnake Compact2 can be used for basic or advanced pipe inspections. To perform a basic inspection, connect any SeeSnake monitor to the Compact2, power on the system, push the push cable through the pipe, and observe the display. An advanced inspection requires a SeeSnake digital reporting monitor and additionally involves capturing media and delivering reports to your customer.

1. Place the Compact2 near the pipe entrance. Make sure the system is stable and the drum can spin freely.
2. Connect the system cable to the digital reporting monitor.
3. Press the Power key  to power on the system. Alternatively, insert a USB drive into the monitor's USB port and press the Autolog key  to quick-start the inspection.
4. Release the spring clip and, if desired, install a pipe guide or camera head guide to keep the camera centered in the pipe. Make sure the camera lens is clean.
5. Carefully put the camera into the pipe. Protect the push cable from sharp edges at the pipe entrance.
6. Push the camera through the pipe and observe the display.
7. Advanced Options:
  - Set the system zero point, or take a temporary segment distance measurement.
  - Capture media.
  - Create on-screen custom overlay.
  - Locate an inspection point or path.
  - Create and deliver an inspection report to your customer on a USB drive.
8. When the inspection is complete, retrieve the camera and secure the spring in the spring clip.

## Advanced Options

Both basic and advanced pipe inspections can include taking pipe segment distance measurements, adjusting the camera's LED brightness, or activating the sonde. Depending on your digital reporting monitor's features, you may also want to capture media and create reports.

*Note: Refer to your digital reporting monitor manual for instructions on capturing media and creating reports.*

- Press the Brightness key  to turn up the brightness of the camera LEDs so you can see further down the pipe.
- Capture media of the inspection by pressing the Video key , Autolog key , or Photo key . If you are using a CS6Pak, you must insert a USB drive prior to capturing media.
- Press and hold the Zero key  for three seconds to set the system zero point wherever you want to begin counting from.
- Use a RIDGID SeekTech locating receiver to locate a point of interest with the integrated 512 Hz sonde.
- Use a RIDGID SeekTech locating receiver with a transmitter to find the path of a pipe by line tracing the push cable.

## Best Practices

Refer to the following tips and recommendations to perform the pipe inspection with efficiency and ease. Following these tips can increase the longevity and effectiveness of your equipment and prevent damage.

- **Run water through the pipe during the inspection to keep the camera system clean, make pushing the push cable easier, and allow longer pushes. Place a hose down the pipe or turn on a fixture. Shut off the water flow as needed for a clear view.**
- Apply a thin film of liquid detergent or soap on the camera to help keep the lens clear.
- Be careful when inspecting porcelain appliances. The camera may scratch the surface finish.
- Sharp edges at the pipe entrance can cut, kink, snag, or damage the push cable. Use extreme care and always keep one hand near the pipe entrance when pushing into the pipe to avoid damaging the push cable.
- Use rubber gripper-type gloves to manipulate the push cable, improve grip, and keep hands clean. Use a quick push to pop the camera around a bend such as a p-trap, tee, Y, or elbow. To pop around a bend, pull the camera back approximately 200 mm [8 in] and thrust it through in one motion. Do not use more force than is necessary.
- The video image is most stable and clear when moving the push cable backward in the pipe. When you have found an area of interest in the pipe, push the camera beyond it and then pull back.
- Dragging the push cable over sharp edges can damage the push cable. Do not drag the push cable over sharp edges and do not pull or bend the push cable at sharp angles at the pipe entrance.

- Some inspection conditions can cause the spring to fold back so that the camera faces the wrong way. If the push cable is visible on the display, the spring has folded over on itself. Pull the push cable back. If necessary, pull the push cable all the way out of the pipe and attempt the inspection again.
- To keep the push cable from folding over on itself, only push short sections through the pipe at a time. If the push cable folds over on itself, it can snap or kink.
- Obstructions or excessive build up in the pipe can damage or prevent retrieval of the camera. Do not use the camera to clear obstructions.

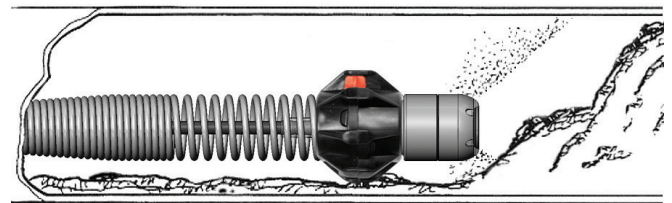

## Pipe Guides

Pipe guides center the camera in the pipe, improve picture quality, and help keep the lens clear. Use pipe guides when possible to reduce wear and tear on the camera system.

Pipe guides can easily be installed, adjusted, and removed to provide better camera and push cable movement in the pipe. For small pipes, tubes, or voids, the camera head guide helps push the camera through stubborn fittings. For larger pipes, ball guides center the camera for better visibility and light illumination.

## Camera Head Guide Installation

The 36 mm [1.4 in] camera head guide can be used in smaller pipes to push the camera through stubborn fittings.

1. Loosen the screws on both sides of the guide until it slides easily onto the camera head.
2. Re-secure the screws until the guide stays in place, but do not over-tighten.



Without Pipe Guide



With Pipe Guide

## Ball Guide Installation

Ball guides are designed to slip onto the spring and lock into place. Depending on work conditions, you can place a ball guide on the spring behind the camera to tilt the camera head upward to view the top of the pipe.

1. Make sure the ball guide is unlocked.
2. Slide the ball guide beyond the camera on to the spring.



3. Press down on the blue locks to secure the ball guide onto the spring.
4. Slide the red locks over the blue locks to secure the ball guide into place.



Locked





Unlocked

**NOTICE** If a ball guide gets snagged in a pipe, it can fall off the spring. To avoid losing ball guides and obstructing the pipe, do not use excessive force to push through the pipe when you feel resistance.

## Locating the Sonde

You can use the integrated sonde to locate a point of interest in the pipe at any time during the inspection. The sonde is located in the spring and is assembled between the end of the push cable and the camera. The sonde transmits a locatable 512 Hz signal that can be detected by receivers such as the RIDGID SeekTech SR-20, SR-24, SR-60, Scout™, or NaviTrack® II.

Press the Sonde key  to enable and disable the sonde. When the sonde is enabled, the LED by the key is lit and the sonde icon  displays on the screen. The 512 Hz sonde signal can cause interference lines that may be visible on captured media.

To locate the sonde, follow these steps:

1. Power on the receiver and set it to sonde mode.
2. Locate the sonde's general direction so you know which way the pipe goes:
  - Power on the sonde and push the push cable no more than 5 m [15 ft] into the pipe.
  - Sweep the horizon with the receiver in a slow arc.
3. The signal strength is highest where the receiver detects the sonde.

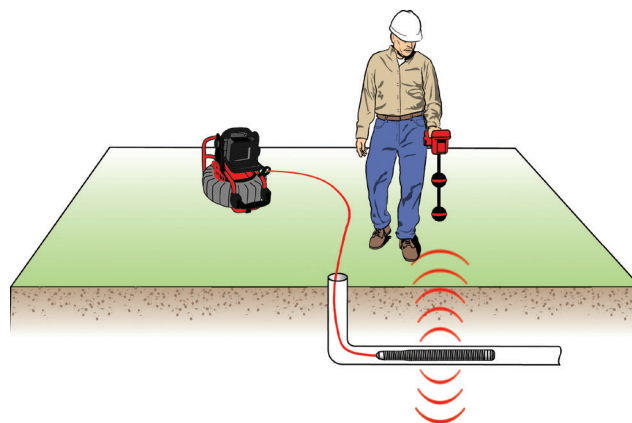

*Note: For additional instructions on sonde locating, refer to the manual for the receiver model you are using.*

## Line Tracing the Push Cable

You can locate the path of a pipe by line tracing the push cable. This is especially useful for inspecting non-metallic or non-conductive pipes. Line trace the push cable by using a tranceiver to induce current onto the push cable using a transmitter.

To line trace the push cable, follow these steps:

1. Push the transmitter's ground stake into the ground and clip one of the transmitter's leads to it.
2. Clip the other lead to the transmitter clip-on terminal on the back of the monitor.



3. Power on the transmitter and set your desired frequency. For best results, use frequencies 33 kHz and higher.
4. Power on the receiver and set it to the same frequency as the transmitter.
5. Trace the line.

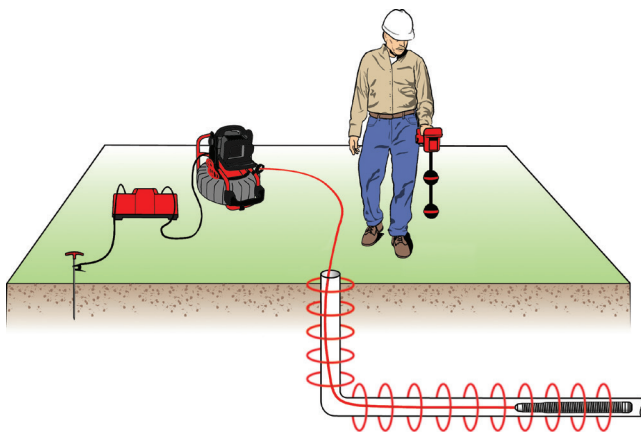

*Note: For additional instructions on line tracing, refer to the manual for the transmitter and receiver models you are using.*

## Retrieving the Camera

After completing the inspection, pull the push cable back out of the pipe with slow, steady force and return it to the drum. Wipe the push cable with a paper towel or cloth as you withdraw it. If possible, continue running water down the pipe to clean the push cable.

To avoid damage to the camera or push cable, do not exert excessive force during retrieval. If the camera head is stuck behind a turn, you can pop the camera past the turn or run water down the pipe to lubricate the push cable.

**NOTICE** Gripping close to the Compact2, always use short strokes to feed back small lengths of the push cable into the drum. Pushing back longer lengths of the push cable or forcing the push cable may cause it to loop, kink, or break.

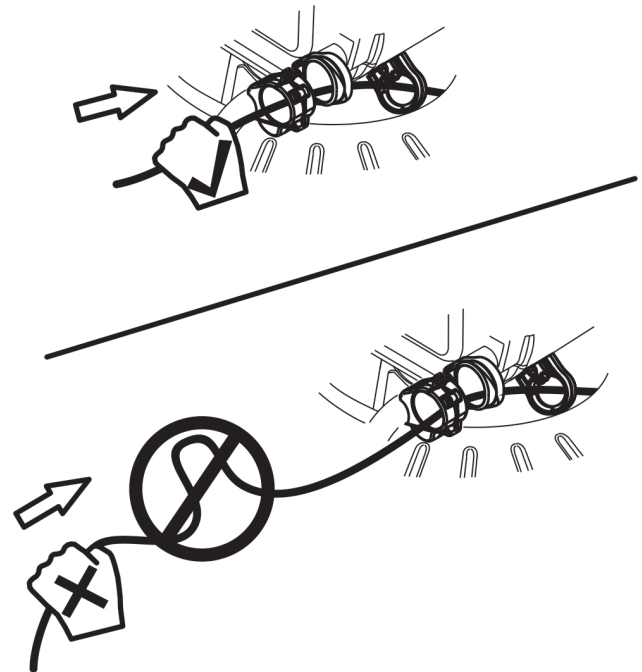



## Individual Components

### Self-Leveling Camera

The bearings and weight of the self-leveling camera may create a swinging effect when you push the push cable through the pipe. The camera image settles quickly when the push cable is steady.

The self-leveling camera can be removed to troubleshoot problems, send for repair, or to replace. Refer to Appendices C and D for instructions on how to remove and install the camera head.

### System Cable Assembly

The system cable assembly includes the system connector, for connecting to SeeSnake digital reporting monitors; 3 m [10 ft] of system cable; and the slip-ring assembly, which is made up of the slip-ring dial and the slip-ring cavity on the frame.

Before cleaning the Compact2, ensure the slip-ring dial is locked **6** in the slip-ring cavity. Avoid getting the slip-ring assembly wet when cleaning.

**NOTICE** To avoid damaging the slip-ring contact pins or getting the internal electrical components wet, keep the slip-ring assembly locked.

### System Cable Removal

1. Disconnect the system cable from the reporting monitor and remove the monitor from the docking system.
2. Unwrap the system cable from the cable wraps.
3. Pop the frame cable anchor off the frame and unhook the system cable from the frame hook.

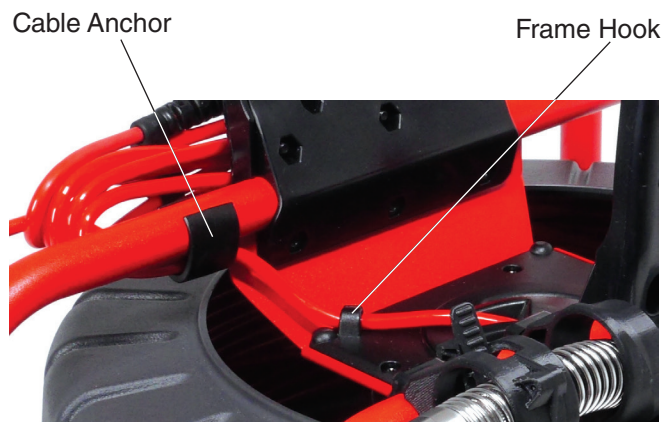

4. Turn the slip-ring dial counter-clockwise to the unlocked position **6**.
5. Pull straight out.

**NOTICE** Do not touch the contact pins inside the slip-ring dial. Stressing the contact pins can cause them to break.

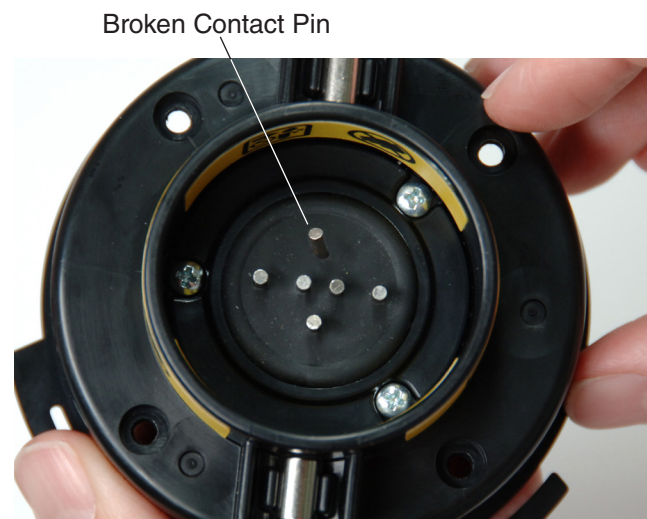

## System Cable Installation

To install the system cable, follow these steps:

1. Align the arrow on the slip-ring dial with the unlock symbol **6** on the frame and insert the slip-ring dial into the slip-ring cavity.
2. Turn the slip-ring dial to the locked position **8**.

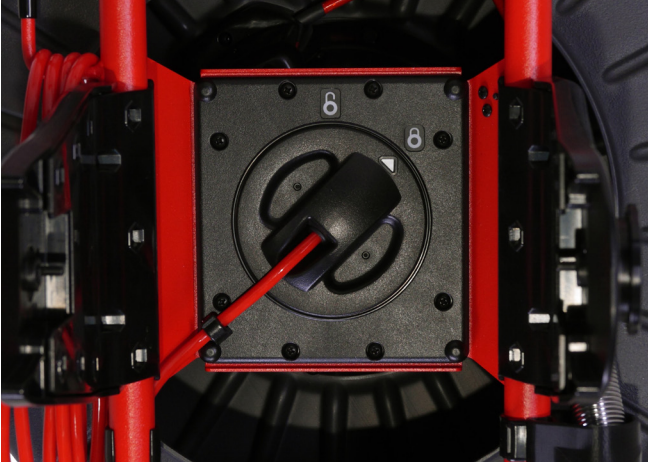

3. Hook the system cable into the frame hook and snap the cable anchor onto the frame.
4. Wrap the system cable around the cable wraps.

## Docking System

**⚠ WARNING**

**Carrying the system incorrectly can cause the monitor's docking handle to disengage from the docking system and may result in property damage and/or serious injury.**

**Do not carry the Compact2 by the monitor's docking handle or its front handle when transporting the system long distances or under conditions where disengagement of the docking system would be hazardous.**

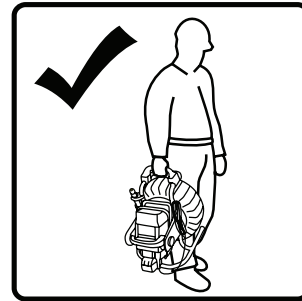

The docking system gives you flexibility with its tilt feature and quick-release knobs. Tilt the digital reporting monitor to any angle for viewing ease or release the CS6Pak from the docking system with the quick-release knobs and place it somewhere more convenient.



The SeeSnake CS6Pak is specifically designed to mount onto the Compact2 and is sold with a compatible docking handle installed. The Compact2 can also be used with a retrofitted SeeSnake MiniPak using the Docking Handle Kit, sold separately.

To make using the setup pictured bottom right most practical, press the Image Flip key  on the CS6Pak for 3 seconds to rotate the user interface. Repeat to return the screen to its normal viewing mode.

*Note: Refer to the Docking Handle Kit for instructions on how to install the docking handle.*

## Mounting the Monitor

1. Turn the docking joints on sides of the docking handle so that the openings point down.



2. Center the CS6Pak over the docking fins and align the docking joints with the joint sockets on the docking fins.

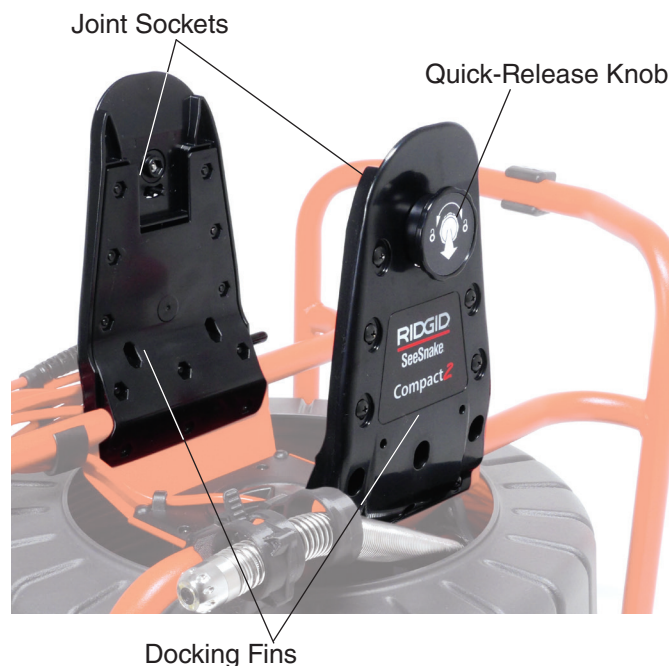

3. Firmly push the monitor down into the docking system until you feel the monitor lock into place.

## Removing the Monitor

1. Place the Compact2 so you can grasp both quick-release knobs.
2. Pull both knobs out and away from the docking fins. In the same motion as pulling the knobs out, turn the knobs together in either direction to disengage the locks.

*Note: The locks are disengaged when the yellow indicator labels are visible under the knobs.*

Yellow Indicator Label



3. Grip the docking handle and pull the digital reporting monitor straight up.

## Maintenance and Support

### Maintaining Components

#### Camera Head

The camera head requires little maintenance other than keeping the LED ring and sapphire window clean. Use a soft nylon brush, mild detergent, and rags to clean the camera.

Scraping tools may permanently scratch the camera. Scratches on the LED ring have a minimal effect on the camera's performance.

**NOTICE** Do not sand the LED ring to remove scratches. Sanding the LED ring can damage the watertight housing.

#### Spring

Stretch the spring end-to-end as far as it allows so you can visually inspect the inner components. Stir the spring in lukewarm water and a mild detergent to flush away debris.

#### Push Cable

Keep the push cable clean. Run a rag over the push cable as it goes back into the drum after each inspection to clean it and reduce debris accumulation.

Visually inspect the push cable for cuts and abrasions while pushing it back into the drum. Replace or repair the push cable if the outer jacket is cut or abraded.

## Cleaning

For light cleaning, use a soft, damp cloth to wipe down the Compact2. If desired, you can use a disinfectant.

**NOTICE** Using solvents to clean any part of the system can affect waterproofing.

To thoroughly clean the Compact2, follow these steps:

1. Prepare:
  - Disconnect the system cable from the digital reporting monitor and remove the monitor from the docking system.
  - Make sure the slip-ring dial is in the locked **8** position.
  - Push the camera through all three push cable guides and into the drum so the drum can spin freely.
2. Stand the Compact2 upright and pour lukewarm water and a mild detergent into the drum.



**NOTICE** High pressure water can damage the seals that protect the electronics inside the drum.

3. Spin the drum to loosen the debris.
4. Tip the drum opening down to empty the water.
5. In a large area, pull the push cable through the guides and completely out of the drum. Do not try to coil the push cable outside of the drum.
6. Use a hose to clean the empty drum.
7. Fully dry the Compact2. Run a rag over the push cable while you push it back into the drum.

## Accessories

Only use accessories specifically designed and recommended for use with the SeeSnake Compact2. Accessories designed for use with other tools may become hazardous when used with the Compact2.

The following RIDGID products have been designed to function with the Compact2:

- Pipe Guide Kit
- Docking Handle Kit
- Shoulder Strap
- RIDGID SeekTech or NaviTrack Receivers
- RIDGID SeekTech or NaviTrack Transmitters
- RIDGID SeeSnake Digital Reporting Monitors
- RIDGID SeeSnake Original Monitors

## Transport and Storage

Store and transport your equipment with the following in mind:

- Store in a locked area out of the reach of children and people unfamiliar with its purpose.
- Store in a dry place to reduce risk of electrical shock.
- Store away from heat sources such as radiators, heat registers, stoves, and other products (including amplifiers) that produce heat.
- Storage temperature should be -10°C to 70°C [14°F to 158°F].
- Do not expose to heavy shocks or impacts during transport.

## Service and Repair

Improper service or repair can cause the SeeSnake Compact2 to be unsafe to operate.

Service and repair of the Compact2 must be performed at a RIDGID Independent Authorized Service Center. To maintain the safety of the tool, make sure a qualified repair person services your equipment using only identical replacement parts. Discontinue using the Compact2 and contact service personnel under any of the following conditions:

- If liquid has been spilled or objects have fallen into the equipment.
- If the equipment does not operate normally when operating instructions are followed.
- If the equipment has been dropped or damaged.
- If the equipment exhibits a distinct change in performance.

For information on your nearest RIDGID Independent Service Center or any service or repair questions:

- Contact your local RIDGID distributor.
- Go to [www.RIDGID.com](http://www.RIDGID.com).
- Contact RIDGID Technical Services Department at [rtctechservices@emerson.com](mailto:rtctechservices@emerson.com) or, in the USA and Canada, call 800-519-3456.

## Disposal

Parts of the SeeSnake Compact2 contain valuable materials that can be recycled. Dispose of the components in compliance with all applicable regulations. Contact your local waste management authority for more information.



**For EC countries:** Do not dispose of electrical equipment with household waste!

According to the European Guideline 2002/96/EC for Waste Electrical and Electronic Equipment and its implementation into national legislation, electrical equipment that is no longer usable must be collected separately and disposed of in an environmentally correct manner.

Troubleshooting		
Problem	Probable Fault	Solution
No video feedback	No power to the SeeSnake monitor.	Check to make sure the power source is properly connected.
	Slip-ring assembly is broken or the connection is faulty.	Check all alignment and connection pins.
		Check placement and pin condition in the slip-ring assembly.
	SeeSnake system cable connection is faulty.	Check SeeSnake system cable connection. Make sure the connectors are pushed all the way in.
	Camera is faulty.	Isolate the fault to the camera. Refer to Appendix B for instructions.
No count measurement	Older SeeSnake monitors may not be compatible with the Compact2's integrated counter.	Count measurements will show up on job reports, and may show up on the monitor during viewing. A new monitor may be required if capturing count measurements to media is necessary.

## Appendices

### Appendix A: Docking Fin Removal

If you are using the Compact2 with a monitor that does not mount onto the docking system, you can remove the docking fins for easier transport and storage.

1. Unscrew all twelve screws with a Phillips screwdriver from one of the docking fins.



2. Pull apart the fin plates and remove them from the frame.



3. Repeat the same steps for the other side.

### Appendix B: Camera Fault Isolation

1. Remove the camera from the push cable.

*Note: Refer to Appendix C for instructions on how to remove the camera.*

2. Plug the camera directly into the monitor's system cable socket.

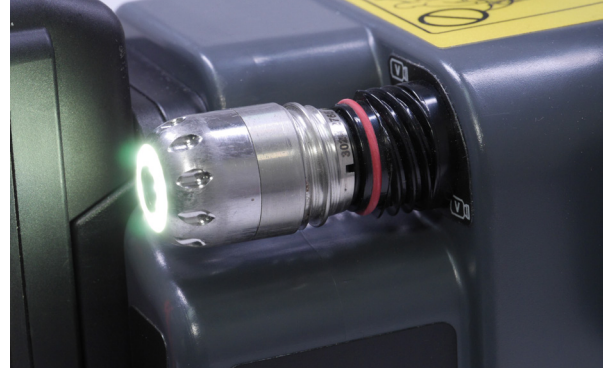

3. Press the Power key  to power on the system. Make sure there is video feedback and the LED lights flash.

- If there is video feedback and the LED lights flash, the camera is working properly.
- If there is no video feedback or if the LED lights do not flash, the camera is at fault.



## Appendix C: Camera Removal

1. Snap the included spanner wrench onto the spring, just behind the camera.



2. Align the notch inside the spanner wrench with the end of the spring coil.



3. Unscrew the spring from the camera.



4. Unscrew the locking sleeve from the camera.

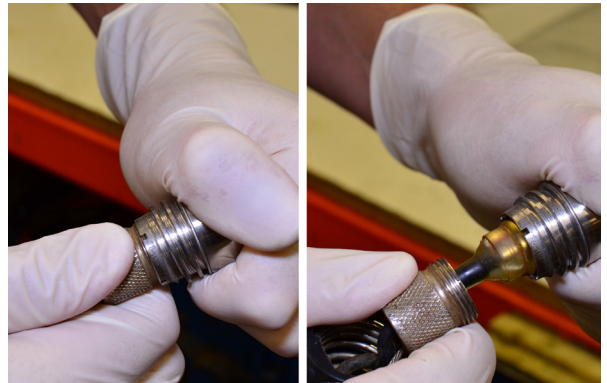

5. Pull the camera straight out of the sonde's socket.

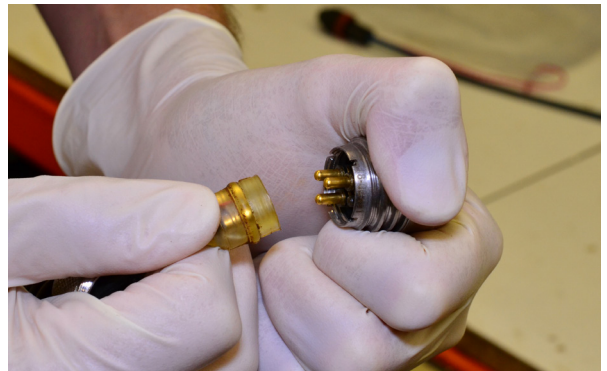

**NOTICE** To avoid damaging the camera's connector pins, do not bend or twist while pulling the camera out of the connector.

## Appendix D: Camera Installation

1. Align the camera head pins with the sonde's socket and push together.



2. Slide push cable locking sleeve onto the camera.



3. To make sure the safety cables end up relatively straight when you screw the camera onto the spring, back-twist the camera by approximately 1 ½ turns (counter-clockwise).



4. The sonde will twist when you thread the camera onto the spring. Rotate the camera one turn counter-clockwise to counteract the twisting and then thread onto the spring.



5. Thread the spring onto the camera until the end of the spring is flush against the camera head.



**NOTICE** Do not over-tighten the spring.

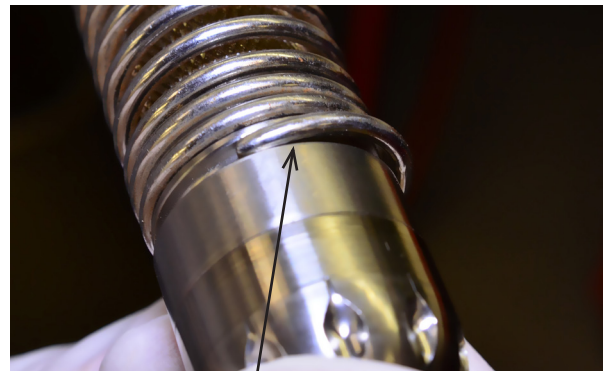

Over-Tightened Spring



WWW.RIDGID.COM

**Ridge Tool Company**  
400 Clark Street  
Elyria, Ohio 44035-6001  
USA

1-800-474-3443

**Ridge Tool Europe**  
Research Park Haasrode  
3001 Leuven  
Belgium

+ 32 (0)16 380 280

© 2014 Ridge Tool Company. All rights reserved.

Every effort has been made to ensure that the information in this manual is accurate. Ridge Tool Company and its affiliates reserve the right to change the specifications of the hardware, software, or both as described in this manual without notice. Visit [www.RIDGID.com](http://www.RIDGID.com) for current updates and supplemental information pertaining to this product. Due to product development, the photos and other presentations specified in this manual may differ from the actual product.

RIDGID and the RIDGID logo are trademarks of Ridge Tool Company, registered in the USA and other countries. All other registered and unregistered trademarks and logos mentioned herein are the property of their respective owners. Mention of third-party products is for informational purposes only and constitutes neither an endorsement nor a recommendation.



**EMERSON. CONSIDER IT SOLVED.™**