

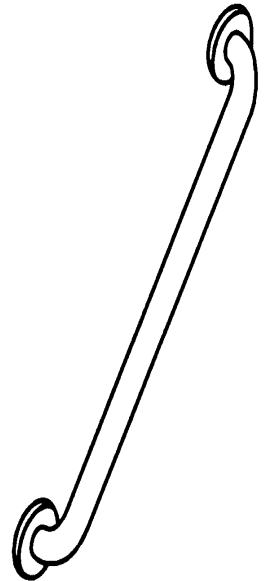

# ELCOMA

Raising the bar since 1988

## ***APRIL 2013 LIST PRICE SHEET***

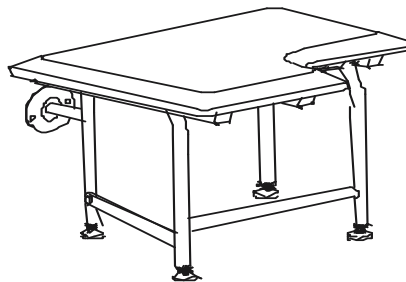
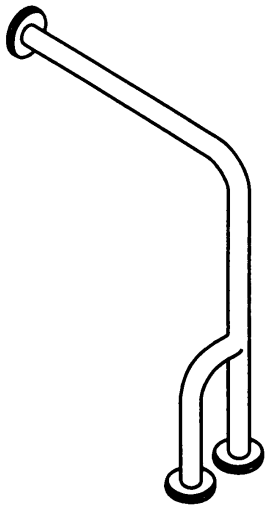

**\* Stainless Steel \* Powdercoated \* Chrome \* Brass \* Antique Brass \* Oil Rubbed Bronze \* Satin Nickel \* Mirror Finish  
\*Rose Gold\* French Gold\* Vibrant Bronze\*Antique Venetian Bronze\***

*Effective 1-1-2012, all full freight orders (25 pieces or more) will only ship complete. If you request us to ship and backorder, Elcoma will pay the freight for the initial shipment only.*

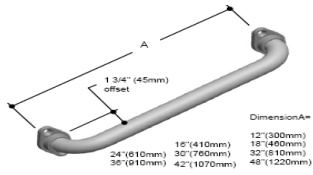

## 1" DIAMETER CHROME STRAIGHT GRAB BARS

### MODEL NUMBER AND SIZE

DESCRIPTION	01-1112 12"	01-1116 16"	01-1118 18"	01-1124 24"	01-1130 30"	01-1132 32"	01-1136 36"	01-1142 42"	01-1148 48"
Smooth Exposed (SL)	37.34	38.16	39.12	42.26	45.31	46.61	49.94	54.29	58.01
Knurled Exposed (KL)	39.56	41.34	42.60	46.66	51.92	54.12	57.39	63.85	69.12
Smooth Exposed w/ Brass Flange (SLBR)	52.80	52.98	53.90	56.95	60.04	62.26	64.39	68.54	72.50
Knurled Exposed w/ Brass Flange (KLBR)	55.30	56.20	57.72	63.95	67.67	69.22	73.08	78.05	83.27

## 1" DIAMETER POWDER COATED WHITE AND ALMOND STRAIGHT GRAB BARS

### MODEL NUMBER AND SIZE

DESCRIPTION	01-1512 12"	01-1516 16"	01-1518 18"	01-1524 24"	01-1530 30"	01-1532 32"	01-1536 36"	01-1542 42"	01-1548 48"
Smooth Exposed (SJ)	43.32	46.32	47.62	54.63	61.01	62.46	69.16	71.61	78.49
Smooth Exposed w/ Brass Flange (SLBR)	54.87	58.35	61.82	67.53	69.13	77.58	85.01	88.10	95.39
Smooth Exposed w/ Chrome Flange (SLCH)	40.14	43.56	45.11	52.74	59.80	60.57	69.02	72.12	78.20

**\*\* Specify color for above bars (01) for White and (02) for Almond \*\***

## 1" DIAMETER BATH GRIP

### MODEL NUMBER AND SIZE

**NEW!!**



<b>EL-551-0562</b>	9" CHROME BATH GRIP <b>35.00</b>
<b>EL-551-0564</b>	9" WHITE BATH GRIP <b>35.00</b>
<b>EL-551-0565</b>	16" CHROME BATH GRIP <b>40.00</b>
<b>EL-551-0567</b>	16" WHITE BATH GRIP <b>40.00</b>



## 1.25" DIAMETER STAINLESS STEEL STRAIGHT GRAB BARS

### MODEL NUMBER AND SIZE

DESCRIPTION	01-2212 12"	01-2216 16"	01-2218 18"	01-2224 24"	01-2230 30"	01-2232 32"	01-2236 36"	01-2242 42"	01-2248 48"
Smooth Concealed (ST)	45.77	47.36	48.55	52.22	55.94	57.12	59.58	63.25	66.90
Knurled Concealed (KT)	50.93	53.91	56.71	62.63	66.59	69.05	74.13	77.91	84.63
Peened Concealed (PT)	50.93	53.91	56.71	62.63	66.59	69.05	74.13	77.91	84.63
Shur-Grip Concealed (GT)	55.30	63.11	64.02	72.68	75.37	78.27	82.87	86.72	95.44

## 1.25" DIAMETER MIRROR FINISH STAINLESS STEEL STRAIGHT GRAB BARS

### MODEL NUMBER AND SIZE

DESCRIPTION	01-2312 12"	01-2316 16"	01-2318 18"	01-2324 24"	01-2330 30"	01-2332 32"	01-2336 36"	01-2342 42"	01-2348 48"
Smooth Concealed (ST)	54.84	58.73	60.61	69.15	72.14	74.47	77.98	83.78	89.90
Knurled Concealed (KT)	57.62	61.50	63.38	72.73	74.91	78.20	80.74	86.54	92.67
Peened Concealed (PT)	57.62	61.50	63.38	72.73	74.91	78.20	80.74	86.54	92.67

## 1.25" DIAMETER POWDER COATED STRAIGHT GRAB BARS

### MODEL NUMBER AND SIZE

DESCRIPTION	01-2612 12"	01-2616 16"	01-2618 18"	01-2624 24"	01-2630 30"	01-2632 32"	01-2636 36"	01-2642 42"	01-2648 48"
Smooth Concealed (ST)	62.84	66.46	68.00	72.53	77.08	78.29	81.63	86.18	90.74
Shur-grip Concealed (GT)	74.61	79.04	82.68	94.96	107.92	111.96	119.68	131.08	143.88
Textured Concealed (TX) * White Only *	67.84	71.46	73.00	77.53	82.08	83.29	86.63	91.18	95.74
Smooth Concealed w/ Chrome Flange (STCH)	72.28	82.99	86.81	99.70	113.32	117.55	125.66	137.65	151.67
Shur-Grip Concealed w/ Chrome Flange (GTCH)	91.53	100.83	106.72	119.49	134.47	139.02	151.37	159.33	174.63
Smooth Concealed w/ Brass Flange (STBR)	72.28	82.99	86.81	99.70	113.32	117.55	125.66	137.65	151.67
Shur-Grip Concealed w/ Brass Flange (GTBR)	91.53	100.83	106.72	119.49	134.47	139.02	151.37	159.33	174.63

\*\* Specify color for above bars (01) for White, (02) for Almond, or (20) for Biscuit \*\*

## 1.25" DIAMETER SPECKLED COATED STRAIGHT GRAB BARS

### MODEL NUMBER AND SIZE

**NEW!!**

DESCRIPTION	01-2612 12"	01-2616 16"	01-2618 18"	01-2624 24"	01-2636" 36"	01-2642 42"
Gold Speckled (GSP)	72.84	76.46	78.00	82.08	91.63	96.18
Silver Speckled (SSP)	72.84	76.46	78.00	82.08	91.63	96.18
Bronze Speckled (BSP)	72.84	76.46	78.00	82.08	91.63	96.18

## 1.25" DIAMETER CHROME STRAIGHT GRAB BARS

(1 YEAR WARRANTY)

### MODEL NUMBER AND SIZE

DESCRIPTION	01-2112 12"	01-2116 16"	01-2118 18"	01-2124 24"	01-2130 30"	01-2132 32"	01-2136 36"	01-2142 42"	01-2148 48"
Smooth Concealed (STA)	65.28	66.04	67.44	71.52	88.84	90.28	93.00	106.32	110.44
Knurled Concealed (KTA)	68.20	69.08	71.00	76.76	95.80	97.72	101.56	116.52	122.28
Shur-Grip Concealed (GTA)	95.64	103.16	106.88	118.16	142.68	146.40	153.96	174.40	185.64

## 1.25" DIAMETER OIL RUBBED BRONZE STRAIGHT GRAB BARS

(1 YEAR WARRANTY)

### MODEL NUMBER AND SIZE



DESCRIPTION	01-2712 12"	01-2716 16"	01-2718 18"	01-2724 24"	01-2730 30"	01-2732 32"	01-2736 36"	01-2742 42"	01-2748 48"
Smooth Concealed (STORB)	72.84	76.46	78.00	82.53	87.08	88.29	91.63	96.18	110.74
Knurled Concealed (KTORB)	80.12	84.10	85.80	90.78	95.78	97.11	100.79	105.79	110.81
Shur-Grip Concealed (GTORB)	84.61	89.04	92.68	104.96	117.92	121.96	129.68	141.08	153.88

*Now available in a Light or Dark ORB finish, Specify -LT after part number for Light or -DK for Dark*

## 1.5" DIAMETER STAINLESS STEEL STRAIGHT GRAB BARS

### MODEL NUMBER AND SIZE



DESCRIPTION	01-5212 12"	01-5216 16"	01-5218 18"	01-5224 24"	01-5230 30"	01-5232 32"	01-5236 36"	01-5242 42"	01-5248 48"
Smooth Concealed (ST)	47.61	50.20	51.46	55.36	59.29	60.55	63.16	67.05	70.91
Knurled Concealed (KT)	53.99	57.16	60.11	66.39	70.58	73.19	78.57	82.58	89.72
Peened Concealed (PT)	53.99	57.16	60.11	66.39	70.58	73.19	78.57	82.58	89.72

## 1.5" DIAMETER OIL RUBBED BRONZE STRAIGHT GRAB BARS

### MODEL NUMBER AND SIZE



DESCRIPTION	01-5712 12"	01-5716 16"	01-5718 18"	01-5724 24"	01-5730 30"	01-5732 32"	01-5736 36"	01-5742 42"	01-5748 48"
Smooth Concealed (STORB)	76.82	80.32	82.11	87.38	92.69	94.48	98.01	103.98	108.61
Knurled Concealed (KTORB)	81.82	88.35	90.32	96.11	101.95	103.92	107.81	114.37	119.47

**\*\* Now available in a Light or Dark ORB finish, Specify -LT after part number for Light or -DK for Dark**

## 1.5" DIAMETER POWDER COATED STRAIGHT GRAB BARS

### MODEL NUMBER AND SIZE



DESCRIPTION	01-5612 12"	01-5616 16"	01-5618 18"	01-5624 24"	01-5630 30"	01-5632 32"	01-5636 36"	01-5642 42"	01-5648 48"
Smooth Concealed (ST)	66.82	70.32	72.11	77.38	82.69	84.48	88.01	93.98	98.61
Textured Concealed (TX) <b>*White Only*</b>	71.82	75.32	77.11	82.38	87.69	89.48	93.01	98.98	103.61

**\*\* Specify color for above bars (01) for White, (02) for Almond**

## 1.5" DIAMETER STAINLESS STEEL PRISON/VANDAL PROOF GRAB BARS

### MODEL NUMBER AND SIZE



DESCRIPTION	06-5212 12"	06-5216 16"	06-5218 18"	06-5224 24"	06-5230 30"	06-5232 32"	06-5236 36"	06-5242 42"	06-5248 48"
Smooth Exposed (SF-PB)	93.15	115.50	135.60	178.20	220.65	240.75	263.16	305.70	348.15

**\*\* Screws not included with vandal proof grab bars but can be purchased separately \*\***

<b>EL-ONEWAYTOOL</b> For installation	<b>EL-ONEWAYPACK</b> 4-Pk of Screws
80.00	6.00

Elcoma is now offering a “PVD” grab bar line. PVD is a manufacturing process that creates a very durable finish that is highly tarnish resistant. Grab bars with the PVD finish will have a 10 warranty.

**NEW!!**

**1.25” DIAMETER \*\* PVD FINISH \*\* STRAIGHT GRAB BARS**

**MODEL NUMBER AND SIZE**

DESCRIPTION	01-2712 12”	01-2716	01-2718	01-2724	01-2730	01-2732	01-2736	01-2742	01-2748
Smooth (ST)	109.92	110.68	112.08	116.16	157.16	158.56	161.28	190.96	195.08
Knurled (KT)	112.84	113.72	115.64	121.40	164.08	164.20	169.84	201.16	206.92
Shurgrip (GT)	122.74	123.11	129.32	142.45	184.59	187.84	194.46	226.66	236.49

**1.25” DIAMETER \*\* PVD FINISH \*\* 90° ANGLE & CORNER BARS**

**30X30 90 DEG ANGLE**

DESCRIPTION	09-273030 30 x 30
Smooth Concealed (STA)	343.27
Knurled Concealed (KTA)	355.16
Shurgrip Concealed (GTA)	382.38

**24X16 OR 32X16 90 DEG ANGLE**

DESCRIPTION	07-272416 24 x 16	07-273216 32 x 16
Smooth Concealed (STA)	338.87	346.95
Knurled Concealed (KTA)	347.91	360.56
Shurgrip Concealed (GTA)	376.71	388.82

**CORNER BAR 34X18**

DESCRIPTION	25-273418 34 x 18
Smooth Concealed (STA)	362.02
Knurled Concealed (KTA)	401.15
Shurgrip Concealed (GTA)	497.58

**\*\*07 part # shown for opposite orientation order part# 08**

SELECT FROM THE FOLLOWING PVD FINISHES BY ADDING THE FINISH CODE TO THE END OF THE ABOVE PART NUMBERS (Example 01-2712ST-RG-BR 12” Smooth Rose Gold Brushed)

**PVD POLISHED**

- CH CHROME
- BS BRASS
- RG ROSE GOLD
- FG FRENCH GOLD

**PVD BRUSHED**

- CH-BR CHROME
- BS-BR BRASS
- FG-BR FRENCH GOLD
- RG-BR ROSE GOLD
- VBZ-BR VIBRANT BRONZE
- AB-BR ANTIQUE BRASS
- AVBZ-BR ANTIQUE VENITION BRONZE
- NP-BR NICKEL

# NEW!!

# MASSIMO

Collection by *ELCOMA*

This Ultimate Collection of Grab Bars is made in the USA. Grab bars have been carefully designed and crafted by an Italian artisan using today's most popular textures and finishes. There are two different flange covers available allowing you to choose between a traditional round flange and a more contemporary square flange.

The Collection is 100% hand made using only recycled and natural materials.

Bars are currently available in 18", 24" and 36" lengths. There are six available textures/grips and thirteen finishes, five of which are polished and eight brushed.

The MASSIMO Collection is the Grab Bar look of the future.

\*Due to the handmade nature of the Collection please allow 3-4 weeks for delivery.



LENGTH	LIST PRICE
18"	225.00
24"	295.00
36"	430.00



## How to order:

1) **CHOOSE LENGTH:** 18", 24", OR 36"

2) **CHOOSE TEXTURE:**

ALICROCK CODE: **-ALI**

COBBLESTONE CODE: **-COBB**

WRINKLED CODE: **-WRINK**

CRACKLE CODE: **-CRACK**

MATRIX CODE: **-MTX**

HAMMERED CODE: **-HAM**

3) **CHOOSE FINISH:**

BRASS: **-BS**

BRASS BRUSHED **-BS-BR**

CHROME **-CH**

CHROME BRUSHED **-CH-BR**

ROSE GOLD **-RG**

ROSE GOLD BRUSHED **-RG-BR**

SATIN NICKLE **-NP**

SATIN NICKEL BRUSHED **-NP-BR**

FRENCH GOLD **-FG**

FRENCH GOLD BRUSHED **-FG-BR**

ANTIQUE VENETIAN BRONZE BRUSHED **-AVBZ-BR**

OIL RUBBED BRONZE BRUSHED **-ORB-BR**

VIBRANT BRONZE BRUSHED **-VB-BR**

4) **CHOOSE FLANGE:**

ROUND **-RD**

SQUARE **-SQ**

**Examples:** 18" Hammered Rose Gold Round  
24" Cobblestone Vibrant Bronze Brushed Square  
36" Wrinkled Brass Square

PART NUMBER: EL-18-HAM-RG-RD  
PART NUMBER: EL-24-COBB-VB-BR-SQ  
PART NUMBER: EL-36-WRINK-BS-SQ

# 1" DIAMETER 90° ANGLE BARS

## MODEL NUMBER AND SIZE

### CHROME

DESCRIPTION	07-112416 24 x 16	07-113216 32 x 16
Smooth Exposed (SL)	71.52	77.66
Knurled Exposed (KL)	76.88	84.18
Smooth Exposed w/ Brass Flange (SLBR)	96.27	102.38
Knurled Exposed w/ Brass Flange (KLBR)	100.33	107.50

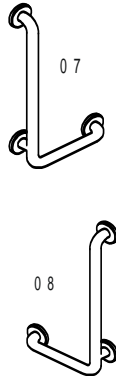

### POWDER COATED

DESCRIPTION	07-152416 24 x 16	07-153216 32 x 16
Smooth Exposed (SJ)	74.52	89.98
Smooth Exposed w/ Brass Flange (SLBR)	91.63	108.26
Smooth Exposed w/ Chrome Flange (SLCH)	71.84	88.73

Specify color for above (01) White or (02)

\*\*07 model shown for opposite orientation order model 08

# 1.25" DIAMETER 90° ANGLE GRAB BARS (1 YEAR WARRANTY)

## MODEL NUMBER AND SIZE

### CHROME

DESCRIPTION	07-212416 24 x 16	07-213216 32 x 16
Smooth Concealed (STA)	263.32	314.52
Knurled Concealed (KTA)	306.64	331.30



### POWDER COATED

DESCRIPTION	07-262416 24 x 16	07-263216 32 x 16
Smooth Concealed (ST)	127.81	137.44
Shurgrip Concealed (GT)	156.93	171.74

Specify color for above (01) White or (02)

### STAINLESS STEEL

DESCRIPTION	07-222416 24 x 16	07-223216 32 x 16
Smooth Concealed (ST)	92.26	98.95
Knurled Concealed (KT)	114.82	123.07
Peened Concealed (PT)	114.82	123.07
Shurgrip Concealed (GT)	124.10	137.11

\*\*07 part # shown for opposite orientation use part# 08



### CHROME

DESCRIPTION	09-213030 30 x 30
Smooth Concealed (STA)	327.32
Knurled Concealed (KTA)	361.86

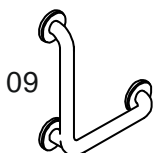

### POWDER COATED

DESCRIPTION	09-263030 30 x 30
Smooth Concealed (ST)	149.11
Shurgrip Concealed (GT)	182.30

Specify color for above (01) White or (02) Almond

### STAINLESS STEEL

DESCRIPTION	09-223030 30 x 30
Smooth Concealed (ST)	122.44
Knurled Concealed (KT)	144.74
Peened Concealed (PT)	144.74
Shurgrip Concealed (GT)	161.12



## 1.5" DIAMETER 90° ANGLE BARS

### MODEL NUMBER AND SIZE

#### POWDER COATED

DESCRIPTION	07-562416 24 x 16	07-563216 32 x 16
Smooth Concealed (ST)	139.09	150.05

#### STAINLESS STEEL

DESCRIPTION	07-522416 24 x 16	07-523216 32 x 16
Smooth Concealed (ST)	100.35	104.88
Knurled Concealed (KT)	121.70	130.47
Peened Concealed (PT)	121.70	130.47

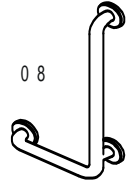
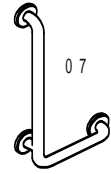

**\*\*07 part # shown for opposite orientation order part# 08**

#### POWDER COATED

DESCRIPTION	09-563030 30 x 30
Smooth Concealed (ST)	162.79

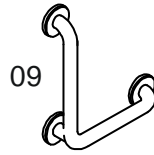

#### STAINLESS

DESCRIPTION	09-523030 30 x 30
Smooth Concealed (ST)	129.78
Knurled Concealed (KT)	153.42
Peened Concealed (PT)	153.42

*Specify color for above (01) White or (02) Almond*

## 1.25" DIAMETER 120° ANGLE GRAB BARS

(1 YEAR WARRANTY)

### MODEL NUMBER AND SIZE

#### CHROME

DESCRIPTION	12-211212 12 x 12	13-211616 16 x 16	13-212424 24 x 24
Smooth Concealed (STA)	198.10	216.08	265.78
Knurled Concealed (KTA)	195.90	238.92	293.84
Shurgrip Concealed (GTA)	231.76	252.80	310.96

#### POWDER COATED

DESCRIPTION	12-261212 12 x 12	13-261616 16 x 16	13-262424 24 x 24
Smooth Concealed (ST)	88.60	97.36	143.49
Shurgrip Concealed (GT)	105.57	119.01	171.95

*Specify color for above (01) White or (02) Almond*

#### STAINLESS STEEL

DESCRIPTION	12-221212 12 x 12	13-221616 16 x 16	13-222424 24 x 24
Smooth Concealed (ST)	59.39	76.12	107.80
Knurled Concealed (KT)	77.11	96.63	128.32
Peened Concealed (PT)	77.11	96.63	128.32
Shurgrip Concealed (GT)	87.76	115.79	147.48

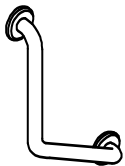

#12

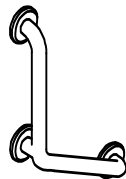

#13

## 1.5" DIAMETER 120° ANGLE GRAB BARS

### MODEL NUMBER AND SIZE

#### POWDER COATED

DESCRIPTION	12-561212 12 x 12	13-561616 16 x 16	13-562424 24 x 24
Smooth Concealed (ST)	98.61	106.31	156.66

*Specify color for above (01) White or (02) Almond*

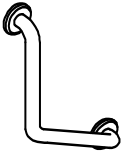

#12

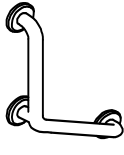

#13

#### STAINLESS STEEL

DESCRIPTION	12-521212 12 x 12	13-521616 16 x 16	13-522424 24 x 24
Smooth Concealed (ST)	65.24	82.25	114.26
Knurled Concealed (KT)	84.72	104.41	136.01
Peened Concealed (PT)	84.72	104.41	136.01

## 1" DIAMETER CHROME WALL TO FLOOR BARS

### MODEL NUMBER AND SIZE

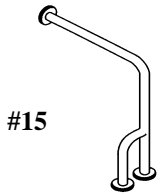

#15

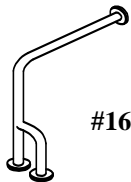

#16

DESCRIPTION	15-113330 RH 33x30	16-113330 LH 33x30
Smooth Exposed (SL)	76.99	76.99
Knurled Exposed (KL)	78.37	78.37
Smooth Exposed w/ Brass Flange (SLBR)	103.14	103.14
Knurled Exposed w/ Brass Flange (KLBR)	108.00	108.00

**1.25" DIAMETER WALL TO FLOOR SAFETY GRAB BARS  
(1 YEAR WARRANTY)**

**MODEL NUMBER AND SIZE**

**CHROME**

DESCRIPTION	14-213330 33x30	15-213330 RH 33x30	16-213330 LH 33x30
Smooth Exposed (SE)	93.89	134.21	134.21
Knurled Exposed (KE)	102.81	140.22	140.22

**POWDER COATED**

DESCRIPTION	14-263330 33x30	15-263330 RH 33x30	16-263330 LH 33x30
Smooth Concealed (ST)	120.67	166.66	166.66
Shurgrip Concealed (GT)	154.04	221.98	221.98

**STAINLESS STEEL**

*Specify color for above (01) White or (02) Almond*

DESCRIPTION	14-223330 33 x 30	15-223330 33 x 30	16-223330 33 x 30
Smooth Concealed (ST)	77.66	143.04	143.04
Knurled Concealed (KT)	93.74	148.01	148.01
Peened Concealed (PT)	93.74	148.01	148.01
Shurgrip Concealed (GT)	128.46	198.35	198.35

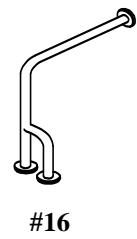
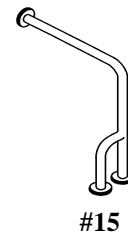
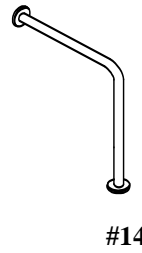

**1.5" DIAMETER WALL TO FLOOR SAFETY BARS**

**MODEL NUMBER AND SIZE**

**POWDER COATED**

DESCRIPTION	14-563330 33x30	15-563330 RH 33x30	16-563330 LH 33x30
Smooth Concealed (ST)	131.74	178.72	178.72

*Specify color (01) White or (02) Almond*

**STAINLESS STEEL**

DESCRIPTION	14-523330 33 x 30	15-523330 33 x 30	16-523330 33 x 30
Smooth Concealed (ST)	86.85	148.94	148.94
Knurled Concealed (KT)	99.14	157.55	157.55
Peened Concealed (PT)	99.14	157.55	157.55

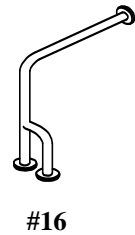
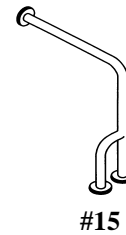
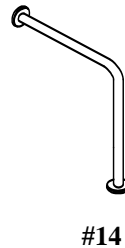

## 1" DIAMETER CHROME INSIDE CORNER BARS

### MODEL NUMBER AND SIZE

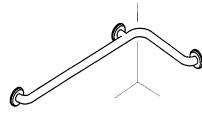

#25

DESCRIPTION	25-113418 34 X 18
Smooth Exposed (SL)	84.30
Knurled Exposed (KL)	89.82
Smooth Exposed w/ Brass Flange (SLBR)	112.65
Knurled Exposed w/ Brass Flange (KLBR)	119.12

## 1.25" DIAMETER INSIDE CORNER BARS

(1 YEAR WARRANTY)

### MODEL NUMBER AND SIZE

#### CHROME

DESCRIPTION	25-213418 34 x 18
Smooth Concealed (STA)	354.38
Knurled Concealed (KTA)	367.18
Shurgrip Concealed (GTA)	414.62

#### STAINLESS STEEL

DESCRIPTION	25-223418 34 x 18
Smooth Concealed (ST)	125.35
Knurled Concealed (KT)	127.13
Peened Concealed (PT)	127.13
Shurgrip Concealed (GT)	149.58

#### POWDER COATED

DESCRIPTION	25-263418 34 x 18
Smooth Concealed (ST)	157.42
Shurgrip Concealed (GT)	178.66

*Specify color for above (01) White or (02) Almond*

#25

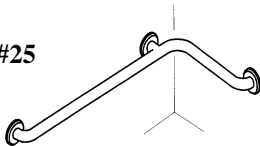

## 1.5" DIAMETER INSIDE CORNER BARS

### MODEL NUMBER AND SIZE

#### POWDER COATED

DESCRIPTION	25-563418 34 x 18
Smooth Concealed (ST)	166.87

*Specify color for above (01) White or (02) Almond*

#### STAINLESS STEEL

DESCRIPTION	25-523418 34 x 18
Smooth Concealed (ST)	126.44
Knurled Concealed (KT)	142.39
Peened Concealed (PT)	142.39

#25

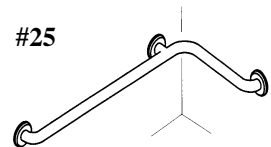

## 1.25" DIAMETER SWING ASIDE GRAB BAR

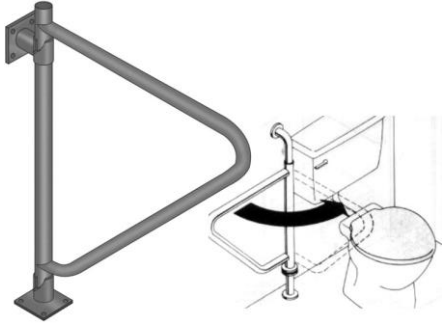

DESCRIPTION	<b>49-223330</b>
Smooth Concealed (ST)	500.00
Peened Concealed (PT)	590.00

## CRESCENT SHOWER RODS

### 5 FOOT

DESCRIPTION	<b>SR-5-</b>
White (W)	65.00
Chrome (SS)	65.00
Satin (BN)	68.00



### 6 FOOT

DESCRIPTION	<b>SR-6-</b>
White (W)	67.00
Chrome (SS)	70.00
Satin (BN)	72.00

**Hardware includes: 4 wood screws, 4 tile anchors, 4 sheetrock anchors, 2 set screws and allen wrench**

# LOCKING AND FRICTION HINGE FLIP UP SAFETY RAILS WITH \*ZINC\* WALL BRACKET

## MODEL NUMBER AND SIZE

### 1.25 LOCKING HINGE STAINLESS STEEL

DESCRIPTION	96-2230 30"
Smooth (SW05)	207.00
Knurled (KW05)	232.00
Peened (PW05)	227.00
Shurgrip (GW05)	247.00

### 1.25 LOCKING HINGE POWDER COATED

DESCRIPTION	96-2630 30"
Smooth (S01)	212.00
Shurgrip (G01)	307.00

*Specify color (01) White or (02) Almond*

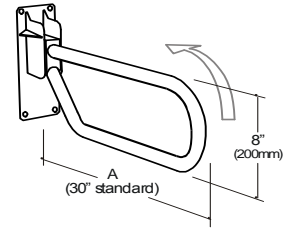

### 1.25 FRICTION HINGE STAINLESS STEEL

DESCRIPTION	99-2230 30"
Smooth (SW05)	217.00
Knurled (KW05)	242.00
Peened (PW05)	237.00
Shurgrip (GW05)	257.00

### 1.25 FRICTION HINGE POWDER COATED

DESCRIPTION	99-2630 30"
Smooth (S01)	222.00
Shurgrip (G01)	317.00

*Specify color (01) White or (02) Almond*

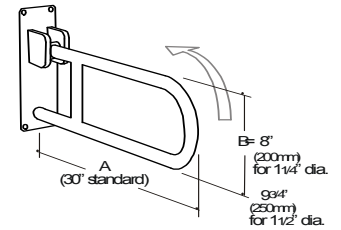

*Mounting hardware included for all flip up safety rails  
(4 – 5/8" x 2-1/2" Stainless Steel Hex Lag Bolts )*

### 1.5 FRICTION HINGE STAINLESS STEEL

DESCRIPTION	99-5230 30"
Smooth (SW05)	227.00
Knurled (KW05)	257.00
Peened (PW05)	252.00

### 1.5 FRICTION HINGE POWDER COATED

DESCRIPTION	99-5630 30"
Smooth (S01)	232.00

*Specify color (01) White or (02) Almond*

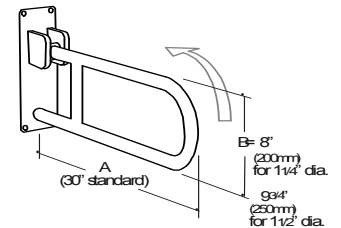

*Mounting hardware included for all flip up safety rails  
(4 – 5/8" x 2-1/2" Stainless Steel Hex Lag Bolts )*

# FRICION HINGE FLIP UP SAFETY RAILS WITH \*STAINLESS STEEL\* WALL BRACKET

## MODEL NUMBER AND SIZE

### 1.25 FRICION HINGE STAINLESS STEEL

DESCRIPTION	97-2230 30"
Smooth (S)	217.00
Knurled (K)	242.00
Peened (P)	237.00
Shurgrip (G)	257.00

### 1.25 FRICION HINGE POWDER COATED

DESCRIPTION	97-2630 30"
Smooth (S01)	222.00
Shurgrip (G01)	317.00

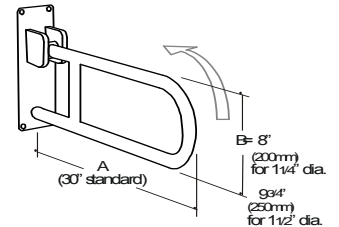

*Specify color (01) White or (02) Almond*

*Mounting hardware included for all flip up safety rails  
(4 – 5/8" x 2-1/2" Stainless Steel Hex Lag Bolts)*

**NEW**

### 1.5 FRICION HINGE STAINLESS STEEL

DESCRIPTION	97-5230 30"
Smooth (S)	227.00
Knurled (K)	257.00
Peened (P)	252.00

### 1.5 FRICION HINGE POWDER COATED

DESCRIPTION	97-5630 30"
Smooth (S01)	232.00

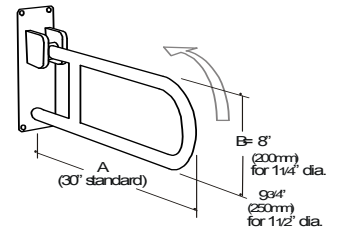

*Specify color (01) White or (02) Almond*

*Mounting hardware included for all flip up safety rails  
(4 – 5/8" x 2-1/2" Stainless Steel Hex Lag Bolts)*

### 1.25 FRICION HINGE STAINLESS STEEL WITH LEG

DESCRIPTION	97-2242 42"	97-2254 54"
Smooth Concealed (SLEG)	465.00	490.00
Knurled Concealed (KLEG)	475.00	505.00
Peened Concealed (PLEG)	475.00	505.00
ShurGrip Concealed (GLEG)	580.00	630.00



*Mounting hardware included for all flip up safety rails  
(4 – 5/8" x 2-1/2" Stainless Steel Hex Lag Bolts)*

# \*HEAVY DUTY\* FLIP UP SAFETY RAILS \*400 LBS\* WEIGHT CAPACITY

## MODEL NUMBER AND SIZE

### 1.25 FRICTION HINGE STAINLESS STEEL

DESCRIPTION	98-2230 30"
Smooth (S)	635.00
Knurled (K)	730.00
Peened (P)	730.00



**NEW**

*Mounting hardware included for all flip up safety rails  
(4 – 5/8" x 2-1/2" Stainless Steel Hex Lag Bolts)*

**NEW!! Heavy Duty Flip Up Rail  
Supports loads up to 400 LBS**

## FLIP UP ACCESSORIES

### TOILET TISSUE HOLDER

DESCRIPTION	Model # And Price
1.25 SS for Locking and Friction Flip up	96-99T 50.00
1.25 Coated for Locking and Friction Flip up	96-99T01 55.00
1.5 SS for Friction Flip up	99-52T 50.00
1.5 Coated for Friction Flip up	99-56T01 55.00

### FLOOR MOUNTED SUPPORT COLUMN

DESCRIPTION	96-	97-	99-
Stainless (CSS)	550.00	550.00	550.00
Powder-Coated –White (CSS01)Almond(CSS02)	575.00	575.00	575.00

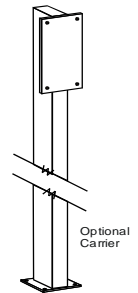

*Specify color (01) White or (02) Almond*

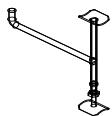

### MOUNTING HARDWARE

DESCRIPTION	999
For Flip Up Rail (MH) (4-Hex Lag Bolts)	22.00
For Support Column (CMH)	22.00

### HEX BOLT COVERS FOR 999MH

DESCRIPTION	999
999-CAPSS Set of 4 SS Caps	10.00
999-CAPWHT Set of 4 White Caps	5.00





## SHOWER SEATS

### ADULT FOLD DOWN L-SHAPED SHOWER SEATS

#### MODEL NUMBER AND SIZE

DESCRIPTION	26 x 21	28 x 21	30 x 21	32 x 21	34.5 x 21
White Padded	61-PA2601 370.00	61-PA2801 375.00	61-PA3001 400.00	61-PA3201 425.00	61-PA34501 435.00
Almond Padded	61-PA2602 370.00	61-PA2802 375.00	61-PA3002 400.00	61-PA3202 425.00	61-PA34502 435.00
White Phenolic	61-PH2601 425.00	61-PH2801 430.00	61-PH3001 455.00	61-PH3201 480.00	61-PH34501 490.00
Woodgrain Phenolic	61-PH2615 425.00	61-PH2815 430.00	61-PH3015 455.00	61-PH3215 480.00	61-PH34515 490.00
White HDP	61-P02620 400.00	61-P02820 405.00	61-P03020 430.00	61-P03220 455.00	61-P034520 465.00
Teakwood	61-TK26 525.00	61-TK28 550.00	61-TK30 565.00	61-TK32 575.00	61-TK345 600.00

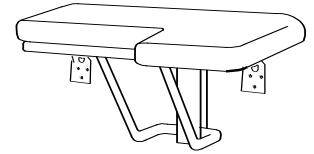

*Model # 61 shown  
For opposite order  
Model # 60*

**NEW**

### ADULT FOLD DOWN L-SHAPED SHOWER SEATS WITH LEGS

#### MODEL NUMBER AND SIZE

DESCRIPTION	26 x 21	28 x 21	30 x 21	32 x 21	34.5 x 21
White Padded	60-PA2601WLEG 610.00	60-PA2801WLEG 615.00	60-PA3001WLEG 640.00	60-PA3201WLEG 665.00	60-PA34501WLEG 670.00
Almond Padded	60-PA2602WLEG 610.00	60-PA2802WLEG 615.00	60-PA3002WLEG 640.00	60-PA3202WLEG 665.00	60-PA34502WLEG 670.00
White Phenolic	60-PH2601WLEG 615.00	60-PH2801WLEG 620.00	60-PH3001WLEG 645.00	60-PH3201WLEG 670.00	60-PH34501WLEG 675.00
Woodgrain Phenolic	60-PH2615WLEG 615.00	60-PH2815WLEG 620.00	60-PH3015WLEG 645.00	60-PH3215WLEG 670.00	60-PH34515WLEG 675.00
White HDP	60-P02620WLEG 590.00	60-P02820WLEG 595.00	60-P03020WLEG 620.00	60-P03220WLEG 645.00	60-P034520WLEG 650.00
Teakwood	60-TK26WLEG 720.00	60-TK28WLEG 725.00	60-TK30WLEG 730.00	60-TK32WLEG 740.00	60-TK345WLEG 780.00

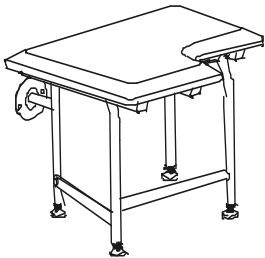

*Model # 60 shown  
For opposite order  
Model # 61*

**NEW**

### ADULT FOLD DOWN RECTANGULAR SHOWER SEATS

#### MODEL NUMBER AND SIZE

DESCRIPTION	24x 14.5	26x 14.5	28 x 14.5	30 x 14.5	32 x 14.5	34.5 x 14.5
White Padded	62-PA2401 285.00	62-PA2601 325.00	62-PA2801 330.00	62-PA3001 355.00	62-PA3201 380.00	62-PA34501 385.00
Almond Padded	62-PA2402 285.00	62-PA2602 325.0	62-PA2802 330.00	62-PA3002 355.00	62-PA3202 380.00	62-PA34502 385.00
White Phenolic	62-PH2401 410.00	62-PH2601 420.00	62-PH2801 425.00	62-PH3001 450.00	62-PH3201 475.00	62-PH34501 480.00
Woodgrain Phenolic	62-PH2415 410.00	62-PH2615 420.00	62-PH2815 425.00	62-PH3015 450.00	62-PH3215 475.00	62-PH34515 480.00
White HDP	62-P02420 385.00	62-P02620 395.00	62-P02820 400.00	62-P03020 425.00	62-P03220 450.00	62-P034520 455.00
Teakwood	62-TK24 500.00	62-TK26 500.00	62-TK28 525.00	62-TK30 550.00	62-TK32 560.00	62-TK345 570.00



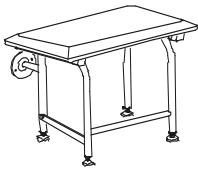

## SHOWER SEATS

### ADULT FOLD DOWN RECTANGULAR SHOWER SEATS WITH LEGS

#### MODEL NUMBER AND SIZE

DESCRIPTION	24 x 14.5	26 x 14.5	28 x 14.5	30 x 14.5	32 x 14.5	34.5 x 14.5
White Padded	62-PA2401WLEG 535.00	62-PA2601WLEG 575.00	62-PA2801WLEG 580.00	62-PA3001WLEG 605.00	62-PA3201WLEG 630.00	62-PA34501WLEG 635.00
Almond Padded	62-PA2402WLEG 535.00	62-PA2602WLEG 575.00	62-PA2802WLEG 580.00	62-PA3002WLEG 605.00	62-PA3202WLEG 630.00	62-PA34502WLEG 635.00
White Phenolic	62-PH2401WLEG 600.00	62-PH2601WLEG 605.00	62-PH2801WLEG 610.00	62-PH3001WLEG 635.00	62-PH3201WLEG 665.00	62-PH34501WLEG 675.00
Woodgrain Phenolic	62-PH2415WLEG 600.00	62-PH2615WLEG 605.00	62-PH2815WLEG 610.00	62-PH3015WLEG 635.00	62-PH3215WLEG 665.00	62-PH34515WLEG 675.00
White HDP	62-P02420WLEG 585.00	62-P02620WLEG 590.00	62-P02820WLEG 615.00	62-P03020WLEG 640.00	62-P03220WLEG 660.00	62-P034520WLEG 670.00
Teakwood	62-TK24WLEG 695.00	62-TK26WLEG 695.00	62-TK28WLEG 700.00	62-TK30WLEG 715.00	62-TK32WLEG 725.00	62-TK345WLEG 750.00

## JR FOLD DOWN SHOWER SEAT

#### MODEL NUMBER AND SIZE

DESCRIPTION	14.5 x 16 (No Legs)	14.5 x 16 (With Legs)	14.5 x 18 (No Legs)	14.5 x 18 (With Legs)
White Padded	63-PA1451601 265.00	63-PA1451601WLEG 480.00	63-PA1451801 330.00	63-PA1451801WLEG 545.00
Almond Padded	63-PA1451602 265.00	63-PA1451602WLEG 480.00	63-PA1451802 330.00	63-PA1451802WLEG 545.00
White Phenolic	63-PH1451601 330.00	63-PH1451601WLEG 535.00	63-PH1451801 335.00	63-PH1451801WLEG 560.00
Woodgrain Phenolic	63-PH1451615 330.00	63-PH1451615WLEG 535.00	63-PH1451815 335.00	63-PH1451815WLEG 560.00
White HDP	63-PO1451620 285.00	63-PO1451620WLEG 500.00	63-PO1451820 300.00	63-PO1451820WLEG 515.00
Teakwood	63-TK14516 375.00	63-TK14516WLEG 525.00	63-TK14518 380.00	63-TK14518WLEG 530.00

*Available with or without legs  
Please specify when ordering*

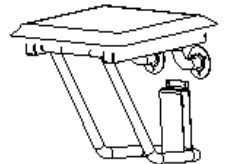

## FLIP UP TUB SEATS

#### MODEL NUMBER AND SIZE

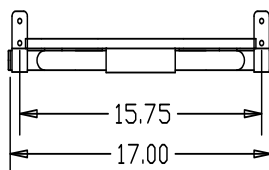
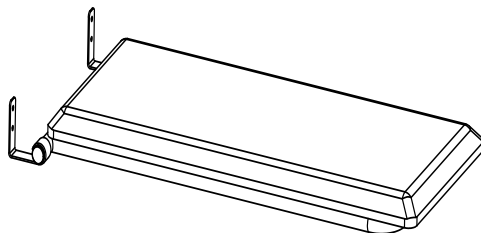

DESCRIPTION	15 x 28	15 x 32
White Padded	70-PA152801 420.00	70-PA153201 430.00
Almond Padded	70-PA152802 420.00	70-PA153202 430.00
White Phenolic	70-PH152801 430.00	70-PH153201 440.00
Woodgrain Phenolic	70-PH152815 430.00	70-PH153215 440.00
White HDP	70-PO152820 430.00	70-PO153220 440.00
Teakwood	70-TK1528 470.00	70-TK1532 480.00

# HOME HEALTH AIDES

## MODEL NUMBER AND SIZE

### TOILET SAFETY FRAME

DESCRIPTION	5472
Chrome Plated	155.00
Stainless Steel (SS)	230.00
Stainless Steel / Handicap Height Toilet (HSS)	276.00

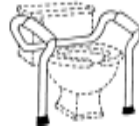

### TUB SAFETY BAR

DESCRIPTION	2511E
White	70.00



### RAISED TOILET SEAT

DESCRIPTION	5411
Raised Toilet Seat	98.00



### BATH BENCH WITH BACK

DESCRIPTION	4311
White (01) Almond (02)	173.00



### SOLID MOUNT

DESCRIPTION	Solid Mount
Fastening System	60.00



### BATH BENCH W/O BACK

DESCRIPTION	4326
White (01) Almond (02)	132.00



### TOGGLE BOLT

DESCRIPTION	Toggle Bolt
Fastening Toggle Bolt	7.00



### TRANSFER BENCH

DESCRIPTION	4371
Transfer Bench	390.00



### WINGIT - COMMERCIAL

DESCRIPTION	WINGIT
Fastening System 1 Req'd per Flange	51.00/ea
Wingit With Extended Length Screw (-E)	53.00/ea
Reverse Wingit (-R)	51.00/ea



### BACKING FOR METAL STUDS

# FLUSH-MOUNT Backing for metal stud Framing (16 gauge)	20.00
--	-------



### WINGIT - RESIDENTIAL

DESCRIPTION	WINGIT
Fastening System (1 PAIR)	25.00/PR

### HAND SHOWER HOLDER FOR GRABBAR

# EL-8005	35.00
-----------	-------



### WINGIT ACCESSORIES

# EL57088 2L 1/2" Hex Shank Hole Saw Arbor	58.00
# EL0204926 1-1/4" Dia Carbide Tipped Hole Saw	74.00
# EL-APACHE Drill Bit for Wingit	27.00
# EL-MAW35 Anchors/Pair	6.00



**NEW!**

## SHOWER CURTAINS AND ACCESSORIES

DESCRIPTION	Shower Curtains	Curtain Flanges	Curtain Hooks	1"SS Tubing for Curtain Rods Sold Per Foot
Weighted	48 x 72 50.00	Stainless (C) 17.00	Chrome 7.00	7.00
	72 x 72 58.00	Chrome (L) 10.00		
Non-Weighted	48 x 72 26.00 72 x 72 34.00	<b>EL-Break</b> Breakaway flange for curtain rod 30.00		



\*\* Flanges sold individually \*\*

## COLLAPSIBLE WATER DAM

### MODEL NUMBER AND SIZE

DESCRIPTION	
Water Dam (Per Foot)	14.00
End Caps (Pair) 90 Degree	18.00
End Caps (Pair) Radius	14.00



*Water Retention System for Barrier Free Showers  
Control water spillage, help prevent falls, and reduce facility liability and maintenance.*

### MODEL NUMBER AND SIZE

## 1" SS CEILING HUNG CURTAIN ROD

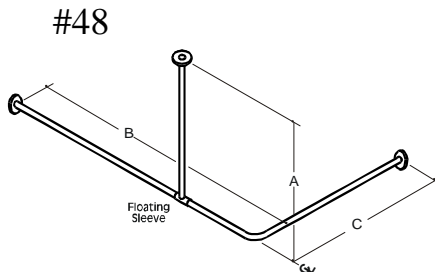

*All sizes with a 36" (A dimension)  
ceiling support. Ceiling support has a  
floating sleeve for adjusting  
Example Part# 48-12A36B\_C\_ST*

DESCRIPTION "B" & "C"	PRICE
66 x 27	209.79
30 x 30	177.78
60 x 30	206.91
36 x 36	189.45
72 x 36	224.37
48 x 48	212.70
60 x 48	224.37
72 x 48	235.98