



# MUSTEE

Preferred by the "Pros"

## 260 DURAWALL® Thermoplastic Shower Walls Square & Rectangular Showers

SEE PAGES 2-3 FOR A LIST OF ACCESSORIES! ▶



### Design features:

- Formed from high-grade thermoplastic
- Ideal for new or remodel projects...fits DURABASE® and CareGiver® Easy Access Shower Floors (see Accessories section) as well as bases from other manufacturers.
- Fits alcoves up to 60" wide by 40" deep
- Includes six large, molded-in, self-draining shelves ideal for shampoo, soap, etc.
- Panels can be trimmed to simplify installation in out-of-plumb alcoves
- Five panel wall system with seamless corner panels and overlapping edges, create a watertight wall surround.
- Designed to fit Mustee's 3060 ShowerTub™ shower floor, and model 360 and 3739 CareGiver® Easy Access Shower Floors.
- Adhesive mounts to drywall or like surfaces
- Available in white or bone
- Smooth, colorfast glossy finish, resists scuffs.
- Mold and mildew-resistant...easy to clean
- Available STYLEMATE® shower enclosures feature tempered safety glass and a range of finishes (see Accessories section).

### Specifications

Model	Color	Fits Alcoves	Shelves	UPC
260WHT	White	Width to 60"; depth to 40"	6	6 71031 00053 8
260BN	Bone	Width to 60"; depth to 40"	6	6 71031 00050 7

**General:** Furnish and install as shown on plans, DURAWALL® Shower Walls Model 260 as manufactured by E.L. Mustee & Sons, Inc. Thermoplastic wall system shall be 5-piece construction with six formed shelves and overlapping corner panels. Uniform color throughout entire thickness of each panel. Color: \_\_\_\_ (White, Bone). Carton Contains: Center Panel, two end panels, two corner panels and instructions. Carton is 36-1/2"x73"x6", Weight 32 lbs.

Requires five or more 11 oz. cartridges of panel adhesive labeled for bonding to Bathtub and Shower walls.

Don't use adhesive containing tar, asphalt, lacquer thinner or toluene.

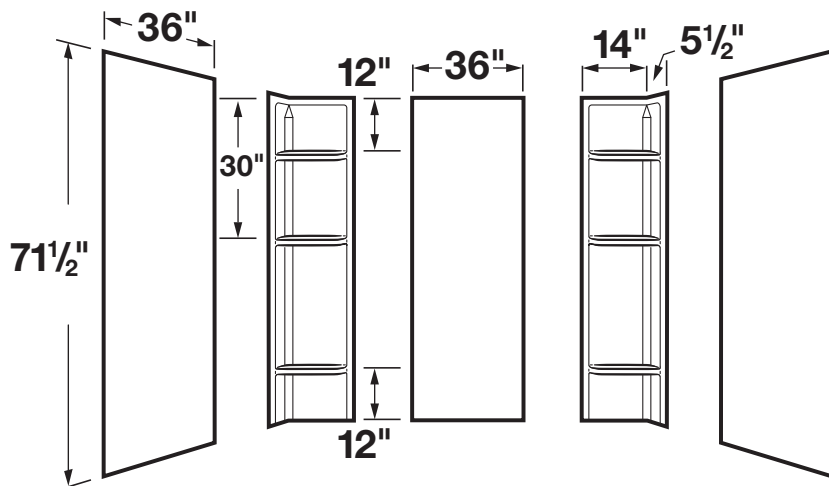

# MUSTEE

E.L. Mustee & Sons, Inc. • 5431 West 164th Street • Brook Park, OH 44142 • Phone: 216.267.3100 • Fax: 216.267.9997  
E-mail: info@mustee.com • Web: www.mustee.com • Proudly made in the USA

Notice: Our continuous commitment to product improvement may result in changes to product specifications without notice. Patents pending. Made and Printed in U.S.A.



▶ **DURABASE® Fiberglass Square & Rectangular Shower Floors**

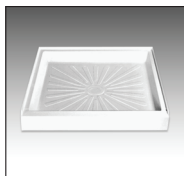

Mustee offers numerous DURABASE® square and rectangular shower floors in white and bone for the 260 DURAWALL® Shower wall, which can fit alcoves up to 60" wide and 40" deep.

▶ **CareGiver® Easy Access Shower Floors**

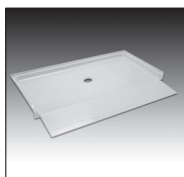

Mustee's popular CareGiver® shower floors are designed to permit easy entry or exit by wheelchairs or walkers.

▶ **CareGiver® Grab Bars**

Straight 304 stainless steel grab bars provide in-shower support and stability.

1½" DIA. INSIDE CORNER STYLES

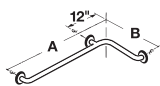

Model	A	— Size —	B	C	UPC
390.304	34"		18"	90°	6 71031 00362 1
390.303	42"		20"	90°	6 71031 00361 4

1½" DIA. STRAIGHT



Model	Size	UPC
390.305	18"	6 71031 00452 9
390.301	24"	6 71031 00359 1
390.306	36"	6 71031 00434 5
390.307	42"	6 71031 00435 2
390.302	48"	6 71031 00360 7

1½" DIA. ANGLED

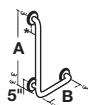

Model	A	— Size —	B	C	UPC
390.308	24"		16"	90°	6 71031 00436 9
390.309	32"		16"	90°	6 71031 00437 6

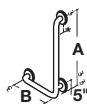

390.310	24"		16"	90°	6 71031 00438 3
390.311	32"		16"	90°	6 71031 00439 0

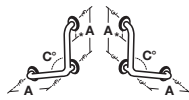

390.312	30"			90°	6 71031 00440 6
390.313	12"	No Corner Flange		120°	6 71031 00441 3
390.314	16"			120°	6 71031 00442 0
390.315	24"			120°	6 71031 00443 7

Rotate for RH or LH use

▶ **CareGiver® Fold-Down Shower Seats**

CareGiver® Fold-Down Shower Seats can be ordered in Right hand, Left hand and Rectangular Fold-Down and Leg-supported styles All popular sizes are available to provide a stable, secure place to sit while showering.

LEFT-HAND SEAT  
— WALL MOUNT

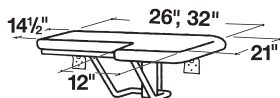

Model	Size	UPC
390.402	26" x 21"	6 71031 00364 5
390.404	32" x 21"	6 71031 00366 9

RIGHT-HAND SEAT  
— WALL MOUNT

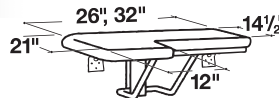

Model	Size	UPC
390.401	26" x 21"	6 71031 00363 8
390.403	32" x 21"	6 71031 00365 2

Continued next page »



# MUSTEE

Preferred by the "Pros"

## 260 DURAWALL® Thermoplastic Shower Walls Square & Rectangular Showers

### CareGiver® Fold-Down Shower Seats (Continued)

CareGiver® Fold-Down Shower Seats can be ordered in Right hand, Left hand and Rectangular Fold-Down and Leg-supported styles. All popular sizes are available to provide a stable, secure place to sit while showering.



LEFT-HAND SEAT  
— WITH LEGS

390.405	26" x 21"	6 71031 00444 4
390.406	32" x 21"	6 71031 00445 1

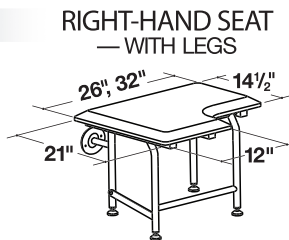

RIGHT-HAND SEAT  
— WITH LEGS

390.407	26" x 21"	6 71031 00446 8
390.408	32" x 21"	6 71031 00447 5

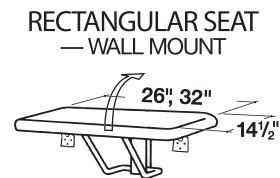

RECTANGULAR SEAT  
— WALL MOUNT

390.409	26" x 14 1/2"	6 71031 00448 2
390.410	32" x 14 1/2"	6 71031 00449 9



RECTANGULAR SEAT  
— WITH LEGS

390.411	26" x 14 1/2"	6 71031 00450 5
390.412	32" x 14 1/2"	6 71031 00451 2

### Enclosures, Pivot and Bypass Doors

Premium quality STYLEMATE® enclosures available for the 260 DURAWALL® shower walls include...

#### STYLEMATE® — PIVOT DOOR ENCLOSURES



Model No.	Finish	Glass	Height	Opening	UPC
32.705	Chrome	Clear	65"	29" – 31"	6 71031 00462 8
32.706	Oil Rubbed Bronze	Clear	65"	29" – 31"	6 71031 00463 5
36.403	Chrome	Clear	65"	34" – 35-1/2"	6 71031 00464 2
36.404	Oil Rubbed Bronze	Clear	65"	34" – 35-1/2"	6 71031 00465 9

#### STYLEMATE® — BY-PASS FRAMED AND BY-PASS FRAMELESS ENCLOSURES

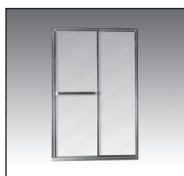

Model No.	Finish	Glass	Height	Opening	UPC
<b>Framed Design</b>					
48.403	Chrome	Clear	69"	47"	6 71031 00466 6
48.404	Brushed Nickel	Clear	69"	47"	6 71031 00467 3
48.405	Oil-Rubbed Bronze	Clear	69"	47"	6 71031 00468 0
<b>Frameless Design</b>					
48.406	Chrome	Clear	69"	47"	6 71031 00469 7
48.407	Brushed Nickel	Clear	69"	47"	6 71031 00470 3
48.408	Oil-Rubbed Bronze	Clear	69"	47"	6 71031 00471 0
<b>Framed Design</b>					
60.403	Chrome	Clear	69"	59"	6 71031 00472 7
60.404	Brushed Nickel	Clear	69"	59"	6 71031 00473 4
60.405	Oil-Rubbed Bronze	Clear	69"	59"	6 71031 00474 1
<b>Frameless Design</b>					
60.406	Chrome	Clear	69"	59"	6 71031 00475 8
60.407	Brushed Nickel	Clear	69"	59"	6 71031 00476 5
60.408	Oil-Rubbed Bronze	Clear	69"	59"	6 71031 00477 2



# MUSTEE

E.L. Mustee & Sons, Inc. • 5431 West 164th Street • Brook Park, OH 44142 • Phone: 216.267.3100 • Fax: 216.267.9997  
E-mail: info@mustee.com • Web: www.mustee.com • Proudly made in the USA

Notice: Our continuous commitment to product improvement may result in changes to product specifications without notice. Patents pending. Made and Printed in U.S.A.