

Mueller Streamline Co.
Address: 8285 Tournament Dr., Suite 150

Memphis, TN 38125

Ph: 901-753-3200

Email: contact@muellerindustries.com
Web: <http://www.muellerindustries.com/>

Item # PF 01376, Copper Reducer, FTG x P, 3" x 2-1/2"

Streamline® PRS™ Copper-Press Fittings is a flameless joining alternative for plumbing or mechanical applications. Available sizes ranging from 1/2" to 4" in diameter.

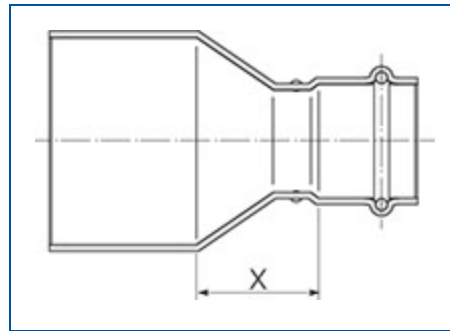
[Specifications](#) | [Dimensions](#) | [Details](#)

Specifications

Weight	1.380 lb
Material	COPPER
Operating Temperature [Min]	-20 °F
Operating Temperature [Max]	250 °F
Operating Pressure [Max]	200 psi
End Type	Fitting
End Size	3 in
Second End Type	Press
Second End Size	2 1/2 in

Standards	ASME B16.51 IAPMO PS-117 NSF/ANSI 61 NSF/ANSI 372 CSA TIL-MSE-13
------------------	--

Dimensions

Overall Length	4.80 in
Overall Height	3.12 in
Overall Width	3.12 in
X	0.98 in

Details

Qty Pcs / Bag	1
Master Qty Pcs / Box	24
Mueller Description	3 FTG X 2-1/2 P FTG RED