

**Mueller Streamline Co.**
**Address:** 8285 Tournament Dr., Suite 150

Memphis, TN 38125

**Ph:** 901-753-3200

**Email:** [contact@muellerindustries.com](mailto:contact@muellerindustries.com)
**Web:** <http://www.muellerindustries.com/>

Item # PF 40124, Copper Tee, P x P x P, 2-1/2" x 2-1/2" x 2"

Tee Reducing Large

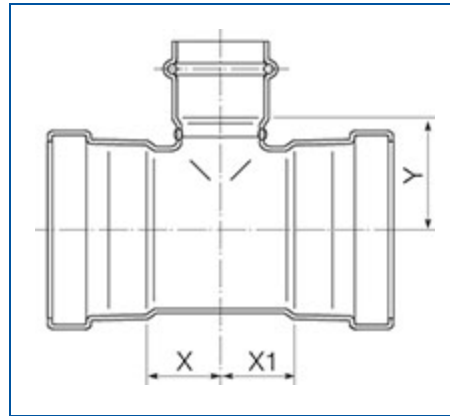
[Specifications](#) | [Dimensions](#) | [Details](#)

## Specifications

<b>Weight</b>	2.120 lb
<b>Material</b>	COPPER
<b>Operating Temperature [Min]</b>	-20 °F
<b>Operating Temperature [Max]</b>	250 °F
<b>Operating Pressure [Max]</b>	200 psi
<b>End Type</b>	Press
<b>End Size</b>	2 1/2 in
<b>Second End Type</b>	Press
<b>Second End Size</b>	2 1/2 in
<b>Third End Type</b>	Press
<b>Third End Size</b>	2 in
	ASME B16.51 IAPMO PS-117

**Standards**NSF/ANSI 61  
NSF/ANSI 372  
CSA TIL-MSE-13**Dimensions**

<b>Overall Length</b>	6.57 in
<b>Overall Height</b>	5.00 in
<b>Overall Width</b>	3.18 in
<b>X</b>	1.59 in
<b>X1</b>	1.59 in
<b>Y</b>	1.83 in

**Details**

<b>Qty Pcs / Bag</b>	1
<b>Master Qty Pcs / Box</b>	12
<b>Mueller Description</b>	2-1/2 X 2-1/2 X 2 P TEE