

Electrical Product Catalog



www.ipexamerica.com



ISSUE DATE: JULY 2013

- Electrical Systems



We build tough products for tough environments.®

Scepter

KWIKON

Sceptacon

KWIKFLEX

SUPER
DUCT

INEXO

Sceptalight



Committed to EXCELLENCE



IPEX USA LLC electrical systems perform in the toughest surroundings underground or above grade. Our comprehensive range of products serve today's electrical, utility and telecommunication infrastructure construction needs.

IPEX products meet or exceed industry standards so you can be confident in partnering with us whether you are specifying, purchasing or installing. IPEX products are the premier choice of electricians, power utilities, telecom service providers and infrastructure contractors. When your reputation is on the line, you can depend on IPEX for quality products and superior service.



Contents

01 ELECTRICAL SYSTEMS

- Scepter Rigid PVC Conduit & Fittings
- Sceptalight Nonmetallic Light Fixtures
- Kwikon ENT Fittings
- INEXO ICF Boxes
- Kwikflex Liquidtight Flexible Nonmetallic Tubing & Fittings
- EPR Repair Kits
- SceptaCon PVC for HDD
- Super Duct Power & Communications Duct



ELECTRICAL TYPE DESIGNATION

UL UNDERWRITERS LABORATORIES INC. (UL 50 AND UL 508)

TYPE DESIGNATION	STANDARD
1	Indoor use primarily to provide protection against contact with the enclosed equipment and against a limited amount of falling dirt.
2	Indoor use to provide a degree of protection against limited amounts of falling water and dirt.
3	Outdoor use to provide a degree of protection against windblown rain; undamaged by the formation of ice on the enclosure.
4	Either indoor or outdoor use to provide a degree of protection against falling rain, splashing water, and hose-directed water; undamaged by the formation of ice on the enclosure.
4X	Either indoor or outdoor use to provide a degree of protection against falling rain, splashing water, and hose-directed water; undamaged by the formation of ice on the enclosure; resists corrosion.
6P	Indoor or outdoor use primarily to provide a degree of protection against hose-directed water, the entry of water during prolonged submersion at a limited depth, and be undamaged by the formation of ice on the enclosure.
12	Indoor use to provide a degree of protection against dust, dirt, fiber flyings, dripping water, and external condensation of noncorrosive liquids.
13	Indoor use to provide a degree of protection and spraying of water, oil, and noncorrosive liquids.

This material is reproduced with permission from Underwriters Laboratories Inc. Standard for Safety for Cabinets and Boxes, UL 50, Copyright 1988 and Industrial Control Equipment, UL 508, Copyright 1994 by Underwriters Laboratories Inc.

Underwriters Laboratories Inc. (UL) shall not be responsible to anyone for the use of or reliance upon a UL Standard by anyone. UL shall not incur any obligation or liability for damages, including consequential damages, arising out of or in connection with the use, interpretation of, or reliance upon a UL Standard.

We introduced PVC pipe in 1951. Since then, the type of challenges industry faces have changed. What hasn't changed is our commitment to meeting your needs. For more than three generations, the Scepter® line of rigid conduit and fittings - has stood for quality, innovation and service.

In addition to our Scepter® brand, we offer the industry's widest selection of electrical nonmetallic tubing and fittings, all backed by a single source. Each product is specifically engineered to meet or even exceed the demanding standards of the electrical construction industries.

Electrical Systems

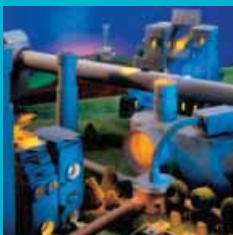

Scepter Rigid PVC Conduit & Fittings	2
Sceptalight Nonmetallic Light Fixtures	36
Kwikon ENT & Fittings	44
INEXO ICF Boxes	52
Kwikflex Liquidtight Flexible Nonmetallic Conduit & Fittings	54
EPR Repair Kits	56
SceptaCon PVC for HDD	58
Super Duct Power & Communications Duct	60

SCEPTER RIGID PVC CONDUIT & FITTINGS

1/2" - 8" (12mm - 200mm)



Professional electricians ask for Scepter conduit by name for the quality and superior performance that ensures a long trouble free life. Scepter conduit is light weight and offers excellent chemical resistance, high tensile and impact strength, and the FT-4 rating permits use in noncombustible construction.

Suitable for exposed, concrete encased and direct burial applications, Scepter conduit requires no extra protection and is third party certified by CSA (sizes 1/2" - 8" and by NSF (sizes 1/2" - 6").

SHORT FORM SPECIFICATIONS

All wiring shall be installed in Rigid PVC conduit and secured to PVC boxes and cabinets by means of proper fittings. All boxes, access fittings and covers shall be furnished with threaded brass inserts, brass screws and PVC gaskets.

Rigid PVC fittings and junction boxes shall be used for all outlets, pull boxes and junction points. All PVC junction boxes shall be NEMA 1, 2, 3, 4, 4X, 6P, 12 and 13 rated and UL Listed for wet locations.

Exposed conduit shall be securely held in place by suitable hangers or straps with the maximum spacing of points for supports not exceeding those specified in the CEC or NEC. Except when embedded in concrete, rigid conduit pipe shall not be clamped tightly. It shall be supported in such a manner as to permit adequate linear movement, allowing for expansion and contraction of conduit due to temperature change. Where a temperature change exceeding 25°F (14°C) is anticipated, rigid PVC expansion joints shall be installed in accordance with the manufacturer's recommendations.

Proper care shall be taken when field bending, to maintain the internal diameter and wall thickness of the conduit.

The contractor shall furnish and install Scepter Rigid PVC conduit pipe and fittings made by IPEX. Where the engineer's specifications indicate Scepter products or equivalent, the equivalent shall be CSA certified and accepted by the Canadian Electrical Code. Due to broad manufacturing tolerances, all pipe and fitting products shall be of the same manufacturer.

APPLICATIONS

- Utilities
- Cable
- Communications
- Residential
- Airports
- Subways
- Bridges & tunnels
- Water treatment plants
- Sewage treatment plants
- Pulp & paper industries
- Street & highway lighting
- Food processing plants
- Agricultural, dairy, hogs, cattle, chicken, etc.
- Parking garages
- Car washes
- Fish plants
- Mines
- Marinas
- Steel mills

STANDARDS



Scepter Rigid PVC Conduit conforms to: CSA C22.2 No. 211.2, CSA C22.2 No. 211.0
NSF Certified to UL651
Sunlight Resistant
Rated for use with 90°C conductors
NEMA TC2
Corps. of Engineers Spec. CE 303:01
Military Spec, Federal Spec. WC 1094A

Scepter Rigid PVC boxes and fittings conform to: CSA C22.2 No. 85

UL Listed UL514B - UL514C

DID YOU KNOW?

Compared to metal, PVC products reduce labour on a typical installation by up to two-thirds. The reason? PVC is easy to work with. It can also be cut and joined without the usual pipe vices, cutters, threading equipment, and reamers associated with metal conduit.

ADVANTAGES

1 Labor Savings

Compared to metal, PVC products reduce labor on a typical installation by up to two-thirds. The reason? PVC is easy to work with. It can also be cut and joined without the usual pipe vices, cutters, threading equipment and reamers associated with metal conduit.

2 Lightweight Conduit

Scepter Rigid PVC Conduit is one-half the weight of aluminum and one-sixth the weight of steel. As a result, handling and installation are easier and faster, reducing labour costs.

3 Easy Joining

Solvent cementing is all that is required, eliminating the need for power-threading machines, pipe vices and cutting equipment. A hacksaw or carpenter's saw is the only equipment required.

4 Strength

Scepter Rigid PVC Conduit offers both high impact and high tensile strength. And, even in cold temperatures, exceeds all CSA and UL standards.

5 Easy Wire Pulls

PVC's exceptionally smooth interior surface greatly reduces the amount of friction while pulling conductors/wires through long runs, even with 90° bends. A large pull-rope and wire-pulling lubricant should be used when pulling all conductors and wires.

6 Noncorroding

PVC is immune to damage from naturally corrosive soil conditions, as well as electro-chemical and galvanic corrosion. This ensures lower maintenance costs and superior performance.

7 Nonconducting

Scepter Rigid PVC Conduit pipe and fittings are nonsparking and nonconducting, thereby eliminating the most dangerous 'second point of contact' and 'phase to ground' faults. The use of a separate grounding conductor in a Scepter PVC conduit system gives a complete and positive ground for the whole system.

8 Chemical resistance

One of the greatest benefits of PVC is its excellent chemical resistance. It resists attack by acids, alkalis, salt solutions, and many other types of chemicals. For more information on PVC and chemical resistance, refer to the IPEX Chemical Resistance Guide.

9 Long Life

Scepter Rigid PVC Conduit pipe and fittings retain their original properties after years of exposure to heat and weather. In addition, resistance to fungi, bacterial action, rodents, termites and corrosive agents ensures a long, trouble-free life for PVC conduit installed indoors or outdoors.

10 Fire Resistant

IPEX's proprietary PVC compound used to manufacture Scepter products is a self-extinguishing material and will not support combustion.

IPEX Compound	Flame Spread	Smoke Developed	Fuel Contribution
1/8" thickness	10 - 20	225 - 270	0
3/4" thickness	10 - 20	300 - 390	0

11 Concrete Tight

Scepter Rigid PVC Conduit pipe and fittings are designed and engineered to be concrete tight in all weather conditions.

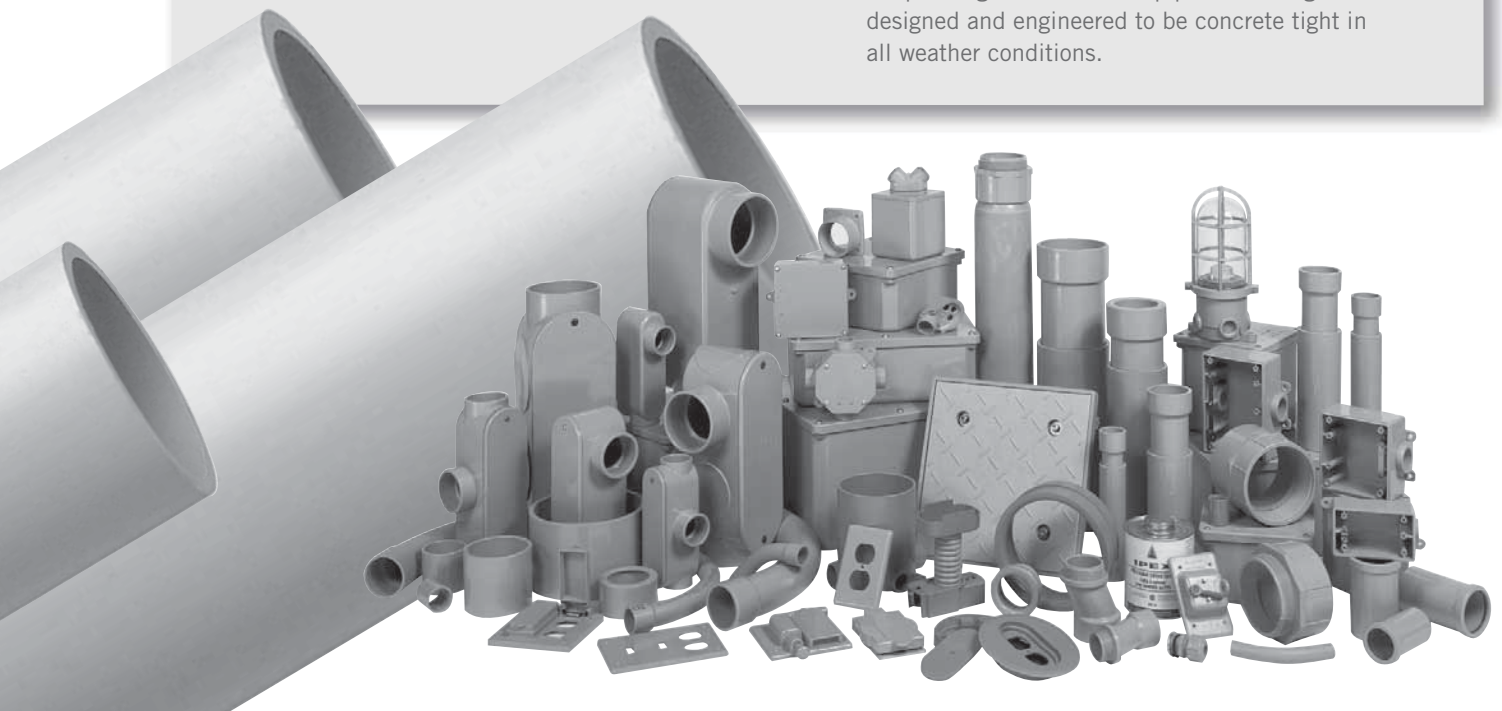

TECHNICAL INFORMATION

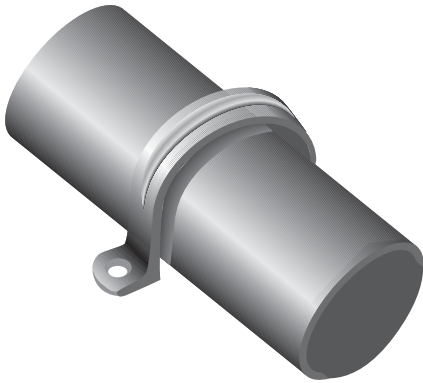

SUPPORT

Due to PVC's light weight, support spacing is different than that used with metal conduits. Supporting straps should NOT be firmly tightened, to allow for linear movement. The maximum allowable support spacing, per the National Electrical Code Article 352.30 (B) is as follows:

SUPPORT SPACING

Nominal Conduit Diameter inches	National Electrical Code Max. Support Spacing feet
1/2	2-1/2
3/4	2-1/2
1	2-1/2
1-1/4	4
1-1/2	4
2	5
2-1/2	6
3	6
3-1/2	7
4	7
5	7
6	8



MAX OPERATING TEMPERATURE

The National Electrical Code (NEC) allows the use of rigid nonmetallic conduit (RNC) and fittings in locations where ambient temperatures are not in excess of 122°F.

CUTTING

Scepter Rigid PVC Conduit can be easily cut on the jobsite by using a hacksaw, carpenter's saw or PVC conduit cutters. For larger sizes of conduit, the use of a mitre box is also recommended to ensure a square cut.

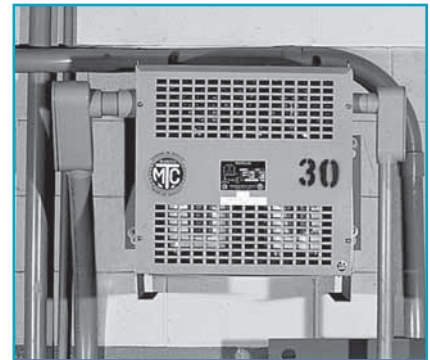

TECHNICAL INFORMATION

SOLVENT CEMENTING

After cutting Scepter Rigid PVC Conduit, remove all sharp edges or burrs from the inside of the conduit with a knife. Thoroughly clean the end of the pipe and inside the fitting with a rag or pipe cleaner. Check the pipe and fitting for a dry fit before cementing. Apply a generous amount of IPEX solvent cement to both surfaces; slide together and give a quarter turn to ensure the solvent is spread evenly on the material. Hold together for a few seconds until the joint is made.

Usually the solvent-cemented joint will be strong enough to install immediately. However, in climates with low temperatures or areas with high humidity, extra time may be required before moving the pipe for permanent installation. Solvent-cemented joints appear to “set up” instantly, but will take up to 24 hours to cure properly. After this time, the solvent-cemented joint has completely cured and is waterproof. For extreme cold weather installations, the use of IPEX PVC Primer is recommended. Normal installation temperatures are between 40°F and 110°F, however, high strength joints have been made at temperatures as low as -15°F with quality cements. In these extreme conditions the cement must be kept warm to prevent excessive thickening and gelation in cold weather.

IPEX cements and primers are available in quarter-pint, half-pint, pint, quart and gallon containers. The shelf life of conduit cement and primer is 2 years from the date of manufacture. The date code stamped on the bottom of the can is the date of manufacture, not the expiry date. Always verify that the cement is within this 2 year time frame before using.



BENDING

PVC is a thermoplastic material that, when heated, becomes soft and pliable. As a result, its shape can be altered.

A flameless heat source is recommended to heat the pipe. AN OPEN FLAME SHOULD NOT BE USED. An electric unit or an infra-red propane unit is recommended for heating the pipe.

The necessary temperature for bending Scepter Rigid PVC pipe is 260°F. The pipe must be heated evenly over an area approximately ten times the diameter of the pipe before any attempt at bending is made. Bending the pipe when it has not been thoroughly heated will cause the pipe to “kink.” With proper care and a little practice, the bend will form easily.

Cooling the pipe with cold air or water will cause “spring back.” Allow a few extra degrees of overbending to compensate for this phenomenon. The maximum bending radius shall be six times the internal diameter according to the National Electrical Code.



TECHNICAL INFORMATION EXPANSION FITTINGS

USING EXPANSION JOINTS

It is equally important to know when to install an expansion joint as it is to know how to correctly install the expansion joint. Expansion joints are required when the temperature change is greater than 25°F. Scepter Rigid PVC Conduit has a coefficient of linear expansion of 3.6×10^{-4} in./ft./°F. Generally, a 100 ft. run of PVC conduit will undergo a change in length of 3.6 inches for every 100°F temperature change.

For conduit installed indoors, the range of expansion and contraction can be calculated using the maximum air temperature plus the heat contributed by the conductors inside the conduit and the minimum air temperature expected. Expansion joints are not required indoors unless there are widely varying temperatures such as the attic of a building.

Conduit installed outdoors, exposed to direct sunlight, will be considerably hotter than the air temperature. As a guideline in this case, add 27°F to the temperature change. Expansion joints should be installed to allow for all anticipated temperature changes.

EXPANSION FORMULA

By using the following formula and the chart below, the total expected expansion in a run can be easily determined:

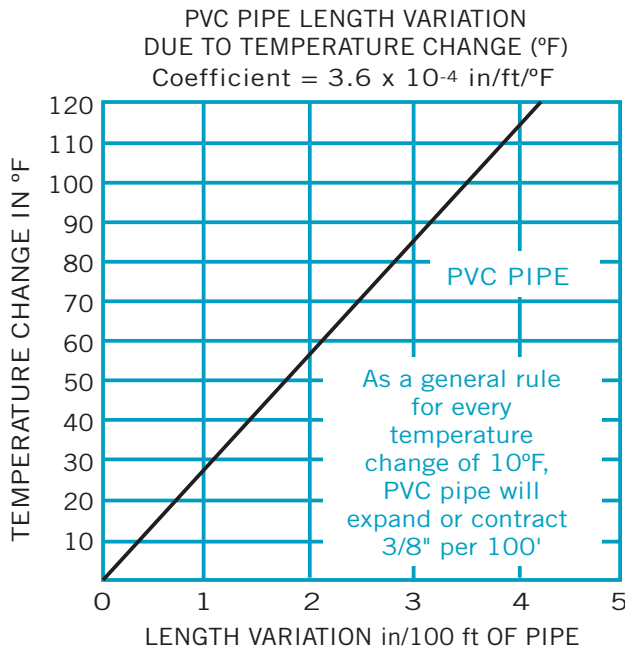

$$\begin{aligned} \text{°F} \quad \text{Total Expansion (in.)} &= \text{length of run (ft.)} \\ &\times \text{temperature change (°F)} \times 0.00036 \end{aligned}$$

TECHNICAL INFORMATION EXPANSION FITTINGS

NUMBER OF EXPANSION JOINTS REQUIRED

Use the following equation to determine the number of expansion joints needed for a Scepter Rigid PVC Conduit installation:

$$\text{Number of joints} = \frac{\text{total expansion (in)}}{E}$$

E = Expansion joint travel length 4" or 8" depending on diameter.

Always round up to the next whole number.

SETTING THE PISTON OPENING

The expansion joint must be installed to allow for expansion and contraction of the conduit run. On a cold day, if an expansion joint is installed completely closed with the piston bottomed, there is no room for expansion when the conduit is warmed. If it is installed open to the maximum on a hot day, the expansion joint will pull apart when cooled.

The correct piston opening for any installation condition can be easily determined using the formula below.

$$\text{Piston setting} = \text{compressed length} + \left(\frac{\text{max. temperature} - \text{installation temperature}}{\text{max. temperature} - \text{min. temperature}} \right) \times E$$

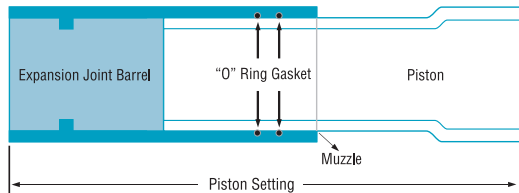

Size (in)	Compressed Length (in)	Travel (in)
1/2	8.00	4
3/4	8.00	4
1	8.50	4
1-1/4	9.00	4
1-1/2	9.00	4
2	9.25	4
2-1/2	9.25	4
3	14.25	8
3-1/2	14.25	8
4	14.25	8
5	14.25	8
6	14.25	8

COMMON MISTAKES

Three common mistakes are:

1. Forgetting to use expansion joints.
2. Not using enough expansion joints.
3. Overtightening of support straps.

It is more cost effective to use more expansion joints than needed, rather than too few. It is difficult to correct the problem after conductors are installed and in service. Failure to accommodate expansion/contraction may result in pipe fracture.

TECHNICAL INFORMATION EXPANSION FITTINGS

INSTALLATION OF EXPANSION JOINTS

USING EXPANSION JOINTS

Proper functioning of an expansion joint depends on three procedures:

1. The correct placement of the expansion joint.
2. The proper installation of Scepter Rigid PVC Conduit and the expansion joint.
3. The proper placement and fastening of support straps.

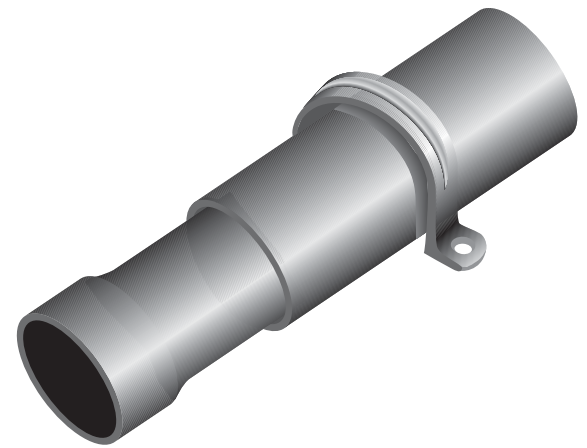

One Expansion Joint - Figure 1

If only one expansion joint is needed between two boxes, the barrel of the joint should be rigidly fastened close to the first box. Scepter Rigid PVC Conduit should then be loosely supported with straps, allowing the conduit to move freely as it expands and contracts.

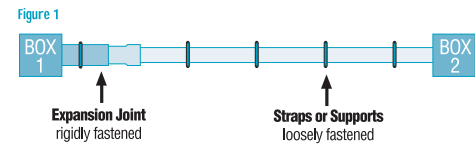

Two Expansion Joints - Figure 2

If two expansion joints are needed, the joints should be firmly fastened back to back at the centre of the run. Scepter Rigid PVC Conduit should be loosely supported with straps, allowing the conduit to move freely as it expands and contracts.

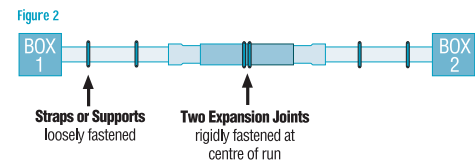

Two Expansion Joints (Alternative) - Figure 3

Alternatively, the centre of the run and the two expansion joints (located at the boxes) should be rigidly fastened. All other support straps should be loosely fastened.

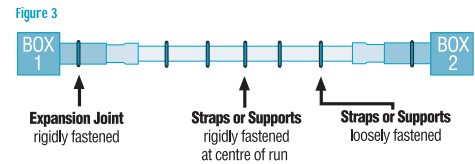

Three or More Expansion Joints - Figure 4

If more than two joints are needed in a very long run, they should be put in a series, one after the other. Each barrel must be rigidly fastened while conduit is loosely supported with straps allowing the conduit to move freely as it expands and contracts. When installed in a series, each section acts independently of the other. Spacing of conduit supports must be in accordance with NEC Article 347-8. (See Table on Support Spacing)

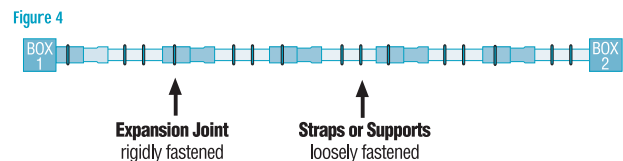

INSTALLATION RECOMMENDATIONS

- Expansion joints should be mounted so the piston can travel in a straight line in the barrel. If the alignment is not straight, the piston will bind, preventing the joint from functioning correctly.
- The expansion joint barrel should be clamped tight, but the conduit mounted loose enough in its hangers to allow for movement as it expands and contracts.
- Scepter nonmetallic straps are correctly sized and designed for proper support, and must be used to secure the conduit.
- When expansion joints are used in a vertical position, the piston should be mounted in a downward position so dirt cannot deposit between the barrel and piston at the muzzle of the expansion joints.

WEIGHT COMPARISON OF SCHEDULE 40 CONDUIT

Nominal Size inches	Sch 40 PVC lbs/100ft	Sch 80 PVC lbs/100ft	Aluminum lbs/100ft	Rigid Steel lbs/100ft
1/2	15	21	28	79
3/4	21	28	27	105
1	31	41	53	153
1-1/4	42	57	70	201
1-1/2	53	70	86	249
2	71	96	116	334
2-1/2	112	146	183	527
3	166	195	239	690
3-1/2	200	-	288	831
4	236	286	340	982
5	321	397	465	1334
6	417	546	613	1771

PHYSICAL PROPERTIES OF PVC TYPE II

Properties	Unit	Value	ASTM Test Method
Electrical			
Dielectric Strength	volts/mil	1215	D149
Dielectric Constant	60 cps at 30°C 1000 cps at 30°C	3.55 3.22	D150 D150
Power Factor	60 cps at 30°C 1000 cps at 30°C	4.04 4.71	D150 D150
Physical			
Specific Gravity		13.5	D792
Hardness	Durometer D	78	D676
Izod Impact Strength @ 73°F (23°C)	ft.lb/in. notch	15.0	D256
Tensile Strength @ 73°F (23°C)	psi	6000	D638
Compressive Strength	psi	8600	D695
Flexural Strength	psi	11500	D790
Thermal			
Coefficient of Thermal Conductivity	BTU/sec/in ² /°F/in.	0.11	C177
Coefficient of Linear Expansion	per °F x 10 ⁻⁵	5.5	D696
Heat Distortion Temperature at 264 psi	°F	158	D648
Others			
Flammability		self-extinguishing	D635
Water Absorption in 30 days	%	0.6	
Color		charcoal grey	
Light Transmission		opaque	D791

All technical data is believed to be accurate and is presented solely for information and guidance.

PRODUCT SELECTION CHART & DIMENSIONS

Nominal Size inches	10' Product Code	20' Product Code	O.D. inches	I.D. inches	Min. Wall inches	Weight lbs./100	Standard 10' ft./crate
------------------------	---------------------	---------------------	----------------	----------------	---------------------	--------------------	---------------------------

Schedule 40 Heavy Wall in 10' or 20' Lengths

1/2	032405	032406	0.840	0.622	0.109	15	6,000
3/4	032407	032408	1.050	0.824	0.113	21	4,400
1	032410	032411	1.315	1.049	0.133	31	3,600
1-1/4	032412	032414	1.660	1.380	0.140	42	3,300
1-1/2	032415	032416	1.900	1.610	0.145	53	2,250
2	032420	032421	2.375	2.067	0.154	71	1,400
2-1/2	032425	032426	2.875	2.469	0.203	112	930
3	032430	032431	3.500	3.068	0.216	166	880
3-1/2	032435	032436	4.000	3.548	0.226	200	630
4	032440	032441	4.500	4.026	0.237	236	570
5	032450	032451	5.563	5.047	0.258	321	380
6	032460	032461	6.625	6.065	0.280	417	260

Schedule 80 Extra Heavy Wall in 10' or 20' Lengths

1/2	032505	032506	0.840	0.546	0.147	21	6,000
3/4	032507	032508	1.050	0.724	0.154	28	4,400
1	032510	032511	1.315	0.957	0.179	41	3,600
1-1/4	032512	032514	1.660	1.278	0.191	57	3,300
1-1/2	032515	032516	1.900	1.500	0.200	70	2,250
2	032520	032521	2.375	1.939	0.218	96	1,400
2-1/2	032525	032526	2.875	2.323	0.276	146	930
3	032530	032531	3.500	2.900	0.300	195	880
4	032540	032541	4.500	3.826	0.337	286	570
5	032550	032551	5.563	4.813	0.375	397	380
6	032560	032561	6.625	5.761	0.432	546	260

CONDUIT ELBOWS

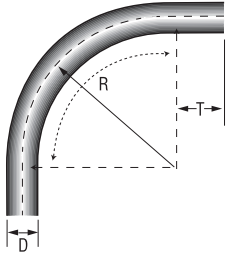

Size inches	Part Number	Product Code	D inches	T inches	R inches
-------------	-------------	--------------	----------	----------	----------

90° Elbows Schedule 40 Standard Radius

1/2	EE1090	068580	0.840	1.500	4.00
3/4	EE1590	068581	1.050	1.500	4.50
1	EE2090	068582	1.315	1.875	5.75
1-1/4	EE2590	068583	1.660	2.000	7.25
1-1/2	EE3090	068584	1.900	2.000	8.25
2	EE3590	056585	2.375	2.000	9.50
2-1/2	EE4090	068586	2.875	3.000	10.50
3	EE4590	068587	3.500	3.125	13.00
3-1/2	EE5090	068588	4.000	3.250	15.00
4	EE5590	068589	4.500	3.375	16.00
5	EE6090	068591	5.563	3.625	24.00
6	EE6590	068592	6.625	3.750	30.00

45° Elbows Schedule 40 Standard Radius

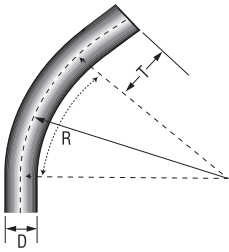

1/2	EE1045	068600	0.840	1.500	4.00
3/4	EE1545	068601	1.050	1.500	4.50
1	EE2045	068602	1.315	1.875	5.75
1-1/4	EE2545	068603	1.660	2.000	7.25
1-1/2	EE3045	068604	1.900	2.000	8.25
2	EE3545	068605	2.375	2.000	9.50
2-1/2	EE4045	068606	2.875	3.000	10.50
3	EE4545	068607	3.500	3.125	13.00
3-1/2	EE5045	068608	4.000	3.250	15.00
4	EE5545	068609	4.500	3.375	16.00
5	EE6045	068611	5.563	3.625	24.00
6	EE6545	068612	6.625	3.750	30.00

30° Elbows Schedule 40 Standard Radius

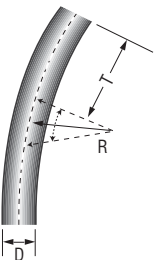

1/2	EE1030	068620	0.840	1.500	4.00
3/4	EE1530	068621	1.050	1.500	4.50
1	EE2030	068622	1.315	1.875	5.75
1-1/4	EE2530	068623	1.660	2.000	7.25
1-1/2	EE3030	068624	1.900	2.000	8.25
2	EE3530	068625	2.375	2.000	9.50
2-1/2	EE4030	068626	2.750	3.000	10.50
3	EE4530	068627	3.500	3.125	13.00
3-1/2	EE5030	068628	4.000	3.250	15.00
4	EE5530	068629	4.500	3.375	16.00
5	EE6030	068631	5.563	3.625	24.00
6	EE6530	068632	6.625	3.750	30.00

CONDUIT ELBOWS

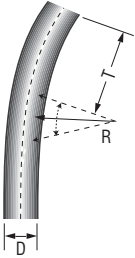

Size inches	Part Number	Product Code	D inches	T inches	R inches
-------------	-------------	--------------	----------	----------	----------

22-1/2° Elbows Schedule 40 Standard Radius

1-1/2	EE1522	078580	1.900	2.000	8.25
2	EE2022	078581	2.375	2.000	9.50
2-1/2	EE2522	078582	2.875	3.000	10.50
3	EE3022	078583	3.500	3.125	13.00
3-1/2	EE3522	078584	4.000	3.250	15.00
4	EE4022	078585	4.500	3.375	16.00
5	EE5022	078586	5.563	3.625	24.00
6	EE6022	078587	6.625	3.750	30.00

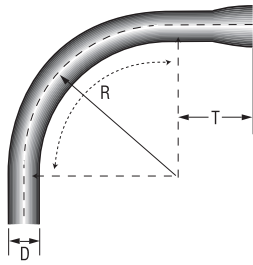

90° Elbows Schedule 40 - Integral Bell End

1/2	EE1090B	068420	0.840	1.500	4.00
3/4	EE1590B	068421	1.050	1.500	4.50
1	EE2090B	068422	1.315	1.875	5.75
1-1/4	EE2590B	068423	1.660	2.000	7.25
1-1/2	EE3090B	068424	1.900	2.000	8.25
2	EE3590B	068425	2.375	2.000	9.50
2-1/2	EE4090B	068426	2.875	3.000	10.50
3	EE4590B	068427	3.500	3.125	13.00
3-1/2	EE5090B	068428	4.000	3.250	15.00
4	EE5590B	068429	4.500	3.375	16.00
5	EE6090B	068430	5.563	3.625	24.00
6	EE6590B	068431	6.625	3.750	30.00

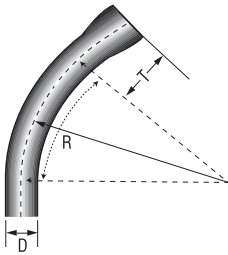

45° Elbows Schedule 40 - Integral Bell End

1/2	EE1045B	068561	0.840	1.500	4.00
3/4	EE1545B	068562	1.050	1.500	4.50
1	EE2045B	068563	1.315	1.875	5.75
1-1/4	EE2545B	068564	1.660	2.000	7.25
1-1/2	EE3045B	068565	1.900	2.000	8.25
2	EE3545B	068566	2.375	2.000	9.50
2-1/2	EE4045B	068567	2.875	3.000	10.50
3	EE4545B	068568	3.500	3.125	13.00
3-1/2	EE5045B	068569	4.000	3.250	15.00
4	EE5545B	068570	4.500	3.375	16.00
5	EE6045B	068571	5.563	3.625	24.00
6	EE6545B	068572	6.625	3.750	30.00

CONDUIT ELBOWS

Size inches	Part Number	Product Code	D inches	T inches	R inches
-------------	-------------	--------------	----------	----------	----------

90° Elbows Schedule 80 Standard Radius

1/2	80EE1090	068690	0.840	1.500	4.00
3/4	80EE1590	068691	1.050	1.500	4.50
1	80EE2090	068692	1.315	1.875	5.75
1-1/4	80EE2590	068693	1.660	2.000	7.25
1-1/2	80EE3090	068694	1.900	2.000	8.25
2	80EE3590	068695	2.375	2.000	9.50
2-1/2	80EE4090	068696	2.875	3.000	10.50
3	80EE4590	068697	3.500	3.125	13.00
4	80EE5590	068698	4.500	3.375	16.00
5	80EE6090	068699	5.563	3.625	24.00
6	80EE6590	068700	6.625	3.750	30.00

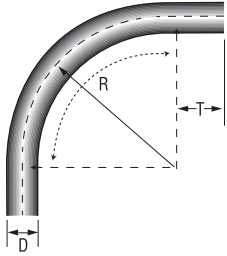

45° Elbows Schedule 80 Standard Radius

1/2	80EE1045	068810	0.840	1.500	4.00
3/4	80EE1545	068811	1.050	1.500	4.50
1	80EE2045	068812	1.315	1.875	5.75
1-1/4	80EE2545	068813	1.660	2.000	7.25
1-1/2	80EE3045	068814	1.900	2.000	8.25
2	80EE3545	068815	2.375	2.000	9.50
2-1/2	80EE4045	068816	2.875	3.000	10.50
3	80EE4545	068817	3.500	3.125	13.00
4	80EE5545	068818	4.500	3.375	16.00
5	80EE6045	068819	5.563	3.625	24.00
6	80EE6545	068820	6.625	3.750	30.00

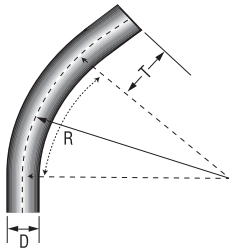

30° Elbows Schedule 80 Standard Radius

1/2	80EE1030	068550	0.840	1.500	4.00
3/4	80EE1530	068551	1.050	1.500	4.50
1	80EE2030	068552	1.315	1.875	5.75
1-1/4	80EE2530	068553	1.660	2.000	7.25
1-1/2	80EE3030	068554	1.900	2.000	8.25
2	80EE3530	068555	2.375	2.000	9.50
2-1/2	80EE4030	068556	2.750	3.000	10.50
3	80EE4530	068557	3.500	3.125	13.00
4	80EE5530	068558	4.500	3.375	16.00
5	80EE6030	068559	5.563	3.625	24.00
6	80EE6530	068560	6.625	3.750	30.00

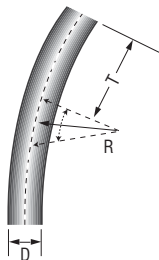

CONDUIT ELBOWS - SCHEDULE 40 SPECIAL RADIUS (PLAIN END)

Size inches	Degree Bend	18" Radius Product Code	24" Radius Product Code	30" Radius Product Code	36" Radius Product Code	48" Radius Product Code	60" Radius Product Code
1	90	068702	068722	068742	068762	068782	#
	45	068802	068822	068842	068862	068882	#
	30	068902	068922	068942	068962	068982	#
	22-1/2	078853	078035	#	#	#	#
1-1/4	90	068703	068723	068743	068763	068783	#
	45	068803	068823	068843	068863	068883	#
	30	068903	068923	068943	068963	068983	#
	22-1/2	068513	078667	#	#	#	#
1-1/2	90	068704	068724	068744	068764	068784	#
	45	068804	068824	068844	068864	068884	#
	30	068904	068924	068944	068964	068984	#
	22-1/2	068523	078668	#	#	#	#
2	90	068705	068725	068745	068765	068785	068113
	45	068805	068825	068845	068865	068885	#
	30	068905	068925	068945	068965	068985	#
	22-1/2	068514	068547	#	068515	#	#
2-1/2	90	068706	068726	068746	068766	068786	#
	45	068806	068826	068846	068866	068886	#
	30	068906	068926	068946	068966	068986	#
	22-1/2	068524		#	#	#	#
3	90	068707	068727	068747	068767	068787	068114
	45	068807	068827	068847	068867	068887	#
	30	068907	068927	068947	068967	068987	#
	22-1/2	068516	068525	#	068517	068526	#
3-1/2	90		068728	068748	068768	068788	#
	45	Use Standard Schedule 40 Elbow	068828	068848	068868	068888	#
	30		068928	068948	068968	068988	#
	22-1/2		068130	#	#	#	#
4	90		068729	068749	068769	068789	068112
	45	Use Standard Schedule 40 Elbow	068829	068849	068869	068889	078011
	30		068929	068949	068969	068989	#
	22-1/2		068518	068519	068520	068521	068111
5	90			068751	068771	068791	068115
	45	Use Standard Schedule 40 Elbow		068851	068871	068891	078615
	30			068951	068971	068991	068132
	22-1/2			068529	068522	#	#
6	90				068772	068792	#
	45	Use Standard Schedule 40 Elbow			068872	068892	078220
	30				068972	068992	#
	22-1/2				068528	068527	078221
8	90	-	-	-	-	068052	#
	45	-	-	-	-	068082	#
	22-1/2	-	-	-	-	068081	#
	11-1/4	-	-	-	-	068080	#

Note: 1) # indicates available on request. Material is **non-cancelable** and **non-returnable**.
 2) Larger Radius Elbows are available on request and are **non-cancelable** and **non-returnable**.

CONDUIT ELBOWS - SCHEDULE 40 SPECIAL RADIUS (BELLED ONE END)

Size inches	Degree Bend	18" Radius Product Code	24" Radius Product Code	36" Radius Product Code	48" Radius Product Code
2	90	068014	068030	068054	068078
	45	068015	068033	068055	068079
2-1/2	90	068016	068034	068056	068086
	45	068017	068035	068057	068090
3	90	068018	068036	068058	068091
	45	068019	068037	068059	068092
3-1/2	90	Use Std. Sch. 40 Radius (15")	068038	068070	068093
	45		068039	068071	068094
4	90	Use Std. Sch. 40 Radius (16")	068050	068072	068095
	45		068053	068073	068096
5	90	Use Std. Sch. 40 Radius (24")		068074	068097
	45			068075	068098
6	90	Use Std. Sch. 40 Radius (30")		068076	068099
	45			068077	068106

CONDUIT ELBOWS - SCHEDULE 80 SPECIAL RADIUS (PLAIN END)

Size inches	Degree Bend	18" Radius Product Code	24" Radius Product Code	30" Radius Product Code	36" Radius Product Code	48" Radius Product Code
1	90	068710	#	#	#	068541
	45	#	#	#	#	#
1-1/4	90	068711	068735	#	#	068542
	45	#	#	#	#	#
1-1/2	90	068712	#	#	068545	068543
	45	#	#	#	#	#
2	90	068713	068736	#	068775	068544
	45	#	068530	#	068534	#
2-1/2	90	068714	068737	#	068776	068548
	45	#	068531	#	068535	#
3	90	068715	068738	#	068777	068794
	45	#	068532	#	068536	#
4	90	068716	068739	068549	068778	068795
	45	#	068533	#	068537	#
5	90	Use Standard Schedule 80 Radius (24")		#	068779	068796
	45			#	068538	068546
6	90				068540	068797
	45				068539	#

- Note:
- 1) # indicates available on request. Material is **non-cancelable** and **non-returnable**.
 - 2) 30° and 22½° Elbows are available on request.
 - 3) Larger Radius Elbows are available on request and are **non-cancelable** and **non-returnable**.

CONDUIT FITTINGS



Size inches	Part Number	Product Code
-------------	-------------	--------------

Pipe Straps PVC 2 Hole

1/2	PS10	077811
3/4	PS15	077812
1	PS20	077813
1-1/4	PS25	077814
1-1/2	PS30	077815
2	PS35	077816



Pipe straps Polyethylene (PE) 2 Hole

2-1/2	PS40	077262
3	PS45	077263
4	PS55	077264



Nonmetallic Conduit Clamps & Wall Spacers

1/2	CCS10	077794
3/4	CCS15	077796
1	CCS20	077797
1-1/4	CCS25	077798
1-1/2	CCS30	077799
2	CCS35	077800
Base	CCS-B	077343

Note: CCS-B are sold individually, two pieces are required to create one base unit.



Pipe straps Coated Steel 1 Hole

1/2	CS10-1	077831
3/4	CS15-1	077832
1	CS20-1	077833
1-1/4	CS25-1	077834
1-1/2	CS30-1	077835
2	CS35-1	077836
2-1/2	CS40-1	077837
3	CS45-1	077838
3-1/2	CS50-1	077839
4	CS55-1	077840

CONDUIT FITTINGS



Size inches	Part Number	Product Code
-------------	-------------	--------------

Pipe straps Coated Steel 2 Hole

2	CS35	077818
2-1/2	CS40	077819
3	CS45	077820
3-1/2	CS50	077821
4	CS55	077822
5	CS60	077824
6	CS65	077823



Poly Plugs

2 - 2-1/2	PP3540	077433
3 - 3-1/2	PP4550	077434
4	PP55	077435
5	PP60	077436
6	PP65	077437

Size inches	Part Number	Product Code	A inches	B inches	C inches
-------------	-------------	--------------	----------	----------	----------

Couplings

1/2	EC10	068000	1.060	0.844	1.400
3/4	EC15	068001	1.310	1.056	1.640
1	EC20	077003	1.590	1.315	2.031
1-1/4	EC25	077004	2.000	1.660	2.156
1-1/2	EC30	077005	2.230	1.900	2.281
2	EC35	077006	2.720	2.375	2.406
2-1/2	EC40	077007	3.320	2.875	3.187
3	EC45	077008	4.000	3.500	3.437
3-1/2	EC50	077009	4.500	4.000	3.625
4	EC55	077010	5.000	4.500	3.750
5	EC60	077011	6.120	5.563	4.187
6	EC65	077012	7.370	6.625	4.562

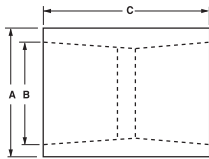
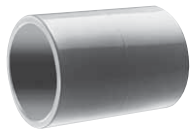

Size inches	Part Number	Product Code	L inches
-------------	-------------	--------------	----------

5° couplings

2	5EC35	077100	4.0
2-1/2	5EC40	077101	5.5
3	5EC45	077103	6.0
3-1/2	5EC50	077102	7.0
4	5EC55	077104	7.0
5	5EC60	077105	7.5
6	5EC65	077106	11.0

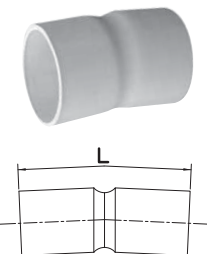

CONDUIT FITTINGS

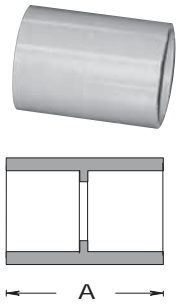

Size inches	Part Number	Product Code	A inches
-------------	-------------	--------------	----------

Long Line Couplings

1-1/2	LLC30	077192	2.740
2	LLC35	077193	3.675
2-1/2	LLC40	077194	4.280
3	LLC45	077195	4.800
4	LLC55	077196	6.200
5	LLC60	077197	8.220
6	LLC65	077198	8.220

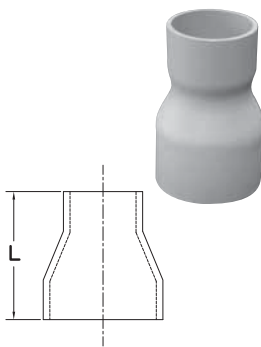

Size inches	Part Number	Product Code	L inches
-------------	-------------	--------------	----------

Fabricated Swedge Reducer Couplings

2 x 1-1/4	SW3525	077320	4
3 x 2	SW4535	077321	6
3 x 2-1/2	SW4540	077335	6.5
4 x 2	SW5535	077322	7
4 x 2-1/2	SW5540	069282	-
4 x 3	SW5545	077333	7

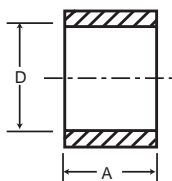

Size inches	Part Number	Product Code	A inches	D Min inches	D Max inches
-------------	-------------	--------------	----------	--------------	--------------

Repair Coupling Sleeve

1-1/2	REC30	077292	2.300	1.912	1.924
2	REC35	077293	2.405	2.367	2.399
2-1/2	REC40	077294	3.450	2.883	2.897
3	REC45	077295	3.600	3.507	3.523
4	REC55	077296	3.920	4.506	4.524
5	REC60	077297	4.275	5.583	5.603
6	REC65	077298	4.620	6.647	6.669

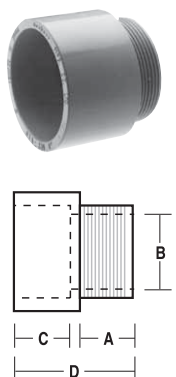

Size inches	Part Number	Product Code	A inches	B inches	C inches	D inches
-------------	-------------	--------------	----------	----------	----------	----------

Terminal Adapters - 1/2" - 1-1/4" Tapered Thread; 1-1/2" - 6" Non-Tapered Thread

1/2	TA10	077021	0.700	0.591	0.750	1.550
3/4	TA15	077022	0.675	0.790	1.000	1.750
1	TA20	077023	0.625	1.000	1.115	1.860
1-1/4	TA25	077024	0.640	1.311	1.300	2.125
1-1/2	TA30	077025	0.725	1.530	1.425	2.250
2	TA35	077026	0.800	1.970	1.150	2.100
2-1/2	TA40	077027	0.800	2.346	1.900	2.930
3	TA45	077028	0.815	2.915	2.000	3.055
3-1/2	TA50	077029	1.000	3.385	1.715	3.055
4	TA55	077030	0.815	3.850	1.990	3.215
5	TA60	077031	1.105	4.810	2.000	5.985
6	TA65	077032	1.105	5.825	2.130	6.500

CONDUIT FITTINGS

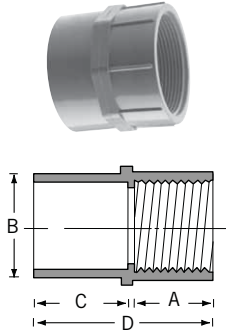

Size inches	Part Number	Product Code	A inches	B inches	C inches	D inches
-------------	-------------	--------------	----------	----------	----------	----------

Female Adapters NPT Tapered Thread

1/2	FA10	077041	0.800	0.620	0.825	1.725
3/4	FA15	077042	0.800	0.820	1.000	1.900
1	FA20	077043	1.000	1.065	1.200	2.300
1-1/4	FA25	077044	1.015	1.395	1.300	2.425
1-1/2	FA30	077045	1.050	1.575	1.290	2.440
2	FA35	077046	1.075	2.050	1.375	2.550
2-1/2	FA40	077047	1.675	2.470	1.985	3.760
3	FA45	077048	1.630	3.090	2.150	4.100
3-1/2	FA50	077049	1.800	3.540	2.000	3.985
4	FA55	077050	1.755	4.025	2.185	4.210
5	FA60	077051	2.065	5.035	3.000	5.240
6	FA65	077052	2.065	6.045	3.000	5.235

Size inches	Part Number	Product Code
-------------	-------------	--------------

End Caps



1/2	CAP10	077421
3/4	CAP15	077422
1	CAP20	077423
1-1/4	CAP25	077424
1-1/2	CAP30	077425
2	CAP35	077426
2-1/2	CAP40	077427
3	CAP45	077428
3-1/2	CAP50	077429
4	CAP55	077430
5	CAP60	077431
6	CAP65	077432

Reducer Bushings



3/4 x 1/2	1805	077300
1 x 1/2	1805-1	077301
1 x 3/4	1806	077302
1-1/4 x 3/4	1807-1	077303
1-1/4 x 1	1807	077304
1-1/2 x 1	1808-1	077305
1-1/2 x 1-1/4	1808	077306
2 x 1	1809-1	077313
2 x 1-1/4	1809	077307
2 x 1-1/2	1810	077308
2-1/2 x 2	1811	077309
3 x 2	1812-1	077310
3 x 2-1/2	1812	077311
4 x 2	1813-1	077319
4 x 3	1813	077312
4 x 3-1/2	1814	077317

CONDUIT FITTINGS



Size inches	Part Number	Product Code
-------------	-------------	--------------

Threaded Reducer Bushings

3/4 x 1/2	1825	077314
1 x 1/2	1826	077315
1 x 3/4	1827	077316



End Bells

1/2	EB-10	077406
3/4	EB-15	077085
1	EB-20	077323
1-1/4	EB-25	077324
1-1/2	EB-30	077325
2	EB-35	077326
2-1/2	EB-40	077327
3	EB-45	077328
3-1/2	EB-50	077329
4	EB-55	077330
5	EB-60	077331
6	EB-65	077332

EXPANSION FITTINGS

For use with Scepter rigid PVC conduit, Scepter Expansion Fittings accommodate for conduit thermal expansion and contraction. Available in an extensive range of sizes, expansion fittings are easily installed for each specific installation. For best performance, it is recommended that the EK is positioned immediately below the meter socket.

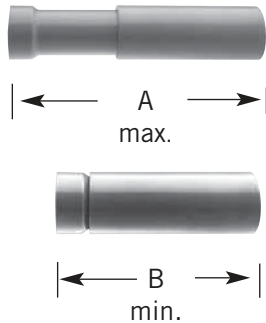

Size inches	Part Number	Product Code	A (inches) max.	B (inches) min.	Travel inches
-------------	-------------	--------------	-----------------	-----------------	---------------

"0" Ring Expansion Joints

1/2	EJ10	077381	12.00	8.00	4
3/4	EJ15	077382	12.00	8.00	4
1	EJ20	077383	12.50	8.50	4
1-1/4	EJ25	077384	13.00	9.00	4
1-1/2	EJ30	077385	13.00	9.00	4
2	EJ35	077386	13.25	9.25	4
2-1/2	EJ40	077387	13.25	9.25	4
3	EJ45	077388	22.25	14.25	8
3-1/2	EJ50	077389	22.25	14.25	8
4	EJ55	077390	22.25	14.25	8
5	EJ60	077391	22.25	14.25	8
6	EJ65	077392	22.25	14.25	8

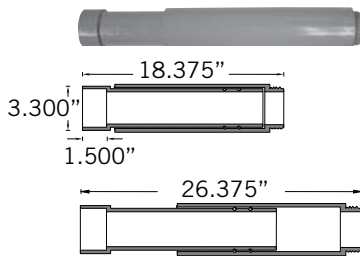

Size inches	Part Number	Product Code
-------------	-------------	--------------

TA Special Expansion Joint

2-1/2	EJ40TA	077398
-------	--------	--------

Dimension (in)	Part Number	Product Code	A Diameter	2 Length	3 Length	Overall Length
----------------	-------------	--------------	------------	----------	----------	----------------

One-Piece Expansion Coupling

1/2	OPEJ10	077018	1.102	0.660	2.465	3.25
3/4	OPEJ15	077019	1.314	0.729	2.646	3.50
1	OPEJ20	077053	1.610	0.885	2.725	3.75
1-1/4	OPEJ25	077054	1.987	0.950	2.895	4.00
1-1/2	OPEJ30	077061	2.208	1.075	3.030	4.25
2	OPEJ35	077063	2.701	1.140	3.206	4.50

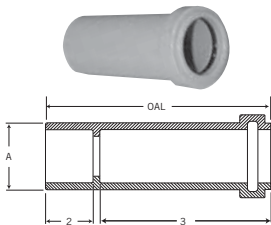

Size inches	Part Number	Product Code	A Ref	B Ref	C Ref	D Ref	E Ref	F Ref
-------------	-------------	--------------	-------	-------	-------	-------	-------	-------

Expansion & Deflection Fitting Assemblies

2*	SE-J-35	077889	9.88	7.38	35.0	9.25	4.25	9.75
3*	SE-J-45	077890	9.88	7.25	40.5	14.50	5.00	10.00
4*	SE-J-55	077891	8.13	7.00	39.0	15.00	5.50	10.00

complete assembly
*Not Certified

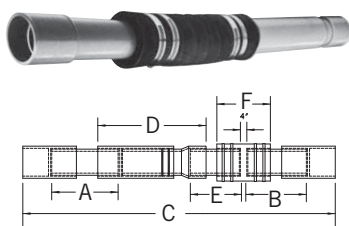

CONDUIT FITTINGS

Size inches	Part Number	Product Code
-------------	-------------	--------------

Nonmetallic Threaded Strain Relief Connectors

c/w "O"Ring, Locknut & 4 Grommets

1/2	TSRCU10	077244
3/4	TSRCU15	077261



Nonmetallic Threaded Strain Relief Connectors

c/w "O"Ring, Locknut & 6 Grommets

1/2	TSRC10	077754
3/4	TSRC15	077756



Strain Relief Connectors c/w Grommets



3/4	SRC15 c/w 6 grommets	077985
3/4	SRCU15 c/w 4 grommets	077209

From inches	To inches
-------------	-----------

Strain Relief Connectors Grommet Dimensions



W = .195 W = .285

L = .450 L = .530



W = .220 W = .291

L = .516 L = .565



Ø = .240 Ø = .300"



Ø = .290 Ø = .385



Ø = .405 Ø = .500



Ø = .525 Ø = .625

Visit our website: www.ipexamerica.com



PRODUCT INFO

TECHNICAL DOCUMENTS
& MUCH MORE ...

+ **DOWNLOAD**

OUR SCEPTER ELECTRICAL
CATALOGUE OR OUR
ELECTRICAL POCKET PRO

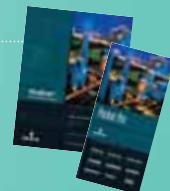

ACCESS FITTINGS

ACCESS FITTINGS

No other manufacturer offers such an extensive range of access fitting sizes (1/2" to 4") or hub configurations (LB, T, LL, LR, TB, C, E). CSA certified and UL listed, Scepter access fittings come fully factory assembled so parts cannot be misplaced during shipping and handling.

Manufactured with threaded brass screws and inserts, and flexible PVC gaskets, Scepter access covers can be removed as often as needed without wear or cracking. Stainless steel screws are available on request.

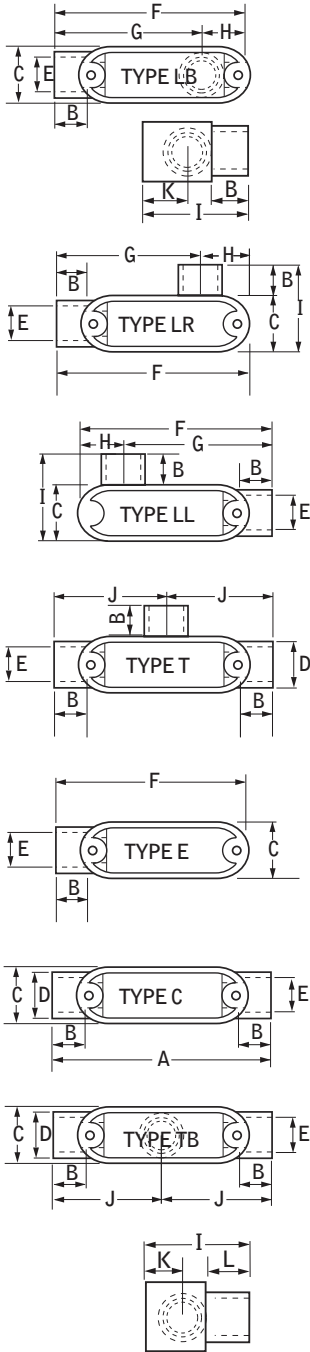

Size inches	A inches	B inches	C inches	D inches	E inches	F inches
1/2	5.606	0.639	1.268	1.100	0.840	4.337
3/4	5.606	0.810	1.536	1.325	1.050	5.395
1	6.500	0.910	1.700	1.660	1.335	6.250
1-1/4	7.900	1.050	2.300	2.250	1.100	7.625
1-1/2	8.500	1.125	2.675	2.250	1.900	8.250
2	10.875	1.160	3.188	2.820	2.375	10.531
2-1/2	14.600	1.750	4.500	3.950	2.870	13.630
3	14.600	1.900	4.500	3.950	3.510	13.630
3-1/2	17.040	2.125	5.536	5.000	4.000	16.000
4	17.040	2.125	5.536	5.000	4.530	16.000

Size inches	G inches	H inches	I inches	J inches	K inches	L inches
1/2	4.095	1.297	2.487	2.280	1.005	0.750
3/4	4.095	1.297	2.487	2.803	1.005	0.810
1	4.750	1.500	2.075	3.250	1.125	1.115
1-1/4	5.750	1.750	3.575	3.950	1.562	1.300
1-1/2	6.500	1.750	3.938	4.250	1.656	1.425
2	8.156	2.344	4.535	5.438	1.968	1.160
2-1/2	9.825	3.805	6.240	7.300	2.610	-
3	10.897	2.733	6.240	7.300	2.610	-
3-1/2	11.465	4.535	7.500	8.535	2.975	-
4	11.465	4.535	7.500	8.535	2.975	-

All access fittings are CSA certified and UL listed for wet locations, except Type TB. Supplied with threaded brass inserts, combination brass head screws and PVC gasketing. Stainless steel screws are available upon request.

ACCESS FITTINGS



Hub Size inches	Part Number	Product Code
Access fittings Type LB		
1/2	SLB10S	077541
3/4	SLB20S	077542
1	SLB30S	077543
1-1/4	SLB40S	077544
1-1/2	SLB50S	077545
2	SLB60S	077546
2-1/2	SLB70S	077547
3	SLB80S	077548
3-1/2	SLB90S	077549
4	SLB100S	077550



Access fittings Type LL		
1/2	SLL10S	077521
3/4	SLL20S	077522
1	SLL30S	077523
1-1/4	SLL40S	077524
1-1/2	SLL50S	077525
2	SLL60S	077526
2-1/2	SLL70S	077527
3	SLL80S	077528
3-1/2	SLL90S	077530
4	SLL100S	077529



Access Fittings Type T		
1/2	ST10S	077461
3/4	ST20S	077462
1	ST30S	077463
1-1/4	ST40S	077464
1-1/2	ST50S	077465
2	ST60S	077466
2-1/2	ST70S	077467
3	ST80S	077468
3-1/2	ST90S	077571
4	ST100S	077572



Access fittings Type LR		
1/2	SLR10S	077481
3/4	SLR20S	077482
1	SLR30S	077483
1-1/4	SLR40S	077484
1-1/2	SLR50S	077485
2	SLR60S	077486
2-1/2	SLR70S	077480
3	SLR80S	077488
3-1/2	SLR90S	077487
4	SLR100S	077489

All access fittings are CSA certified and UL listed for wet locations, except Type TB. Supplied with threaded brass inserts, combination brass head screws and PVC gasketing. Stainless steel screws are available upon request.

ACCESS FITTINGS



Hub Size inches	Part Number	Product Code
Access Fittings Type C		
1/2	SC10S	077501
3/4	SC20S	077502
1	SC30S	077503
1-1/4	SC40S	077504
1-1/2	SC50S	077505
2	SC60S	077506
2-1/2	SC70S	077507
3	SC80S	077508
3-1/2	SC90S	077510
4	SC100S	077509



Hub Size inches	Part Number	Product Code
Access Fittings Type E		
1/2	SE10S	077561
3/4	SE20S	077562
1	SE30S	077563
1-1/4	SE40S	077564
1-1/2	SE50S	077565
2	SE60S	077566
2-1/2	SE70S	077567
3	SE80S	077568
3-1/2	SE90S	077569
4	SE100S	077570



Hub Size inches	Part Number	Product Code
Access Fittings Type TB		
1/2	STB10S	077451
3/4	STB20S	077452
1	STB30S	077453
1-1/4	STB40S	077454
1-1/2	STB50S	077455
2	STB60S	077456



“Two In One” Pull Elbow

The “two in one” access pull elbow reduces inventory costs (3/4" hub fitting supplied with 3/4" x 1/2" reducers). This pull elbow is approved for wet locations and provides for easy wire pulling.

“Two In One” Pull Elbow

Hub Size inches	Part Number	Product Code
1/2 or 3/4	PE15/10	077491

All access fittings are CSA certified and UL listed for wet locations, except Type TB. Supplied with threaded brass inserts, combination brass head screws and PVC gasketing. Stainless steel screws are available upon request.

SERVICE ENTRANCE FITTINGS

Scepter rigid PVC conduit is suitable for use in both overhead and underground service laterals. A complete range of non-corroding PVC service entrance fittings is available, including meter hubs, weather heads and meter offsets.



Size inches	Part Number	Product Code
Service Entrance Fittings		
1/2	EF10	077281
3/4	EF15	077282
1	EF20	077283
1-1/4	EF25	077284
1-1/2	EF30	077285
2	EF35	077286
2-1/2	EF40	077287
3	EF45	077288
3-1/2	EF50	077289
4	EF55	077290



Schedule 40 Slip Meter Risers (c/w TA fitting)		
2	SMR20TA	068371
2-1/2	SMR25TA	068372
3	SMR30TA	068373
4	SMR40TA	068374

Slip Meter Risers allow the underground PVC service conduit to 'slip' inside the fitting and thus account for ground movement. The factory assembled SMR fitting is supplied with a male adapter, is 2 feet in length and is sized to accept the underground raceway (i.e. 2" underground service conduit requires a 2" SMR). The SMR fitting must be installed with the open barrel end towards the ground.



Meter Offsets		
1-1/4	M025	077941
2	M035	077942

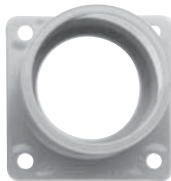

Meter Hubs		
1-1/4	MHU25	077961
1-1/2	MHU30	077963
2	MHU35	077965
2-1/2	MHU40	077967
3	MHU45	077968



Size inches	Part Number	Product Code	A inches	B inches
Long Meter Offsets Fabricated				
1-1/4	LM025	069641	12	0.91
1-1/2	LM030	069645	12	1.61
2	LM035	069646	14	1.50

BOXES - F SERIES

Our complete range of Scepter boxes and covers makes it easy to locate power and control precisely where you want it.

Scepter F-Series 3-in-1 PVC surface mount outlet boxes are available in single (deep), double and triple-gang configurations, with 1/2", 3/4" and 1" entry hubs all in one box. This innovative design enables contractors to reduce inventory, while ensuring they have the size they need when they need it.

With the exception of the FD, FD2 & FD3 Blank Boxes, Scepter F Series Boxes are molded with 1" conduit hubs and supplied with reducer bushings. The conduit hub(s) are field modified as 1/2", 3/4" or 1" to accommodate job-site requirements. The appropriate quantity of 1" x 3/4" and 3/4" x 1/2" reducers to create the desired hub size are packaged with each FD Series Single Gang Deep, Double Gang and Triple Gang Box.

All F Series boxes are supplied with integral mounting feet, threaded brass inserts and grounding screw.

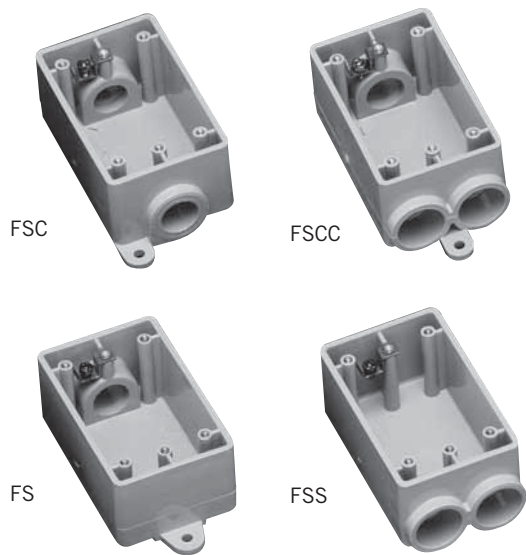

Hub Size inches	Part Number	Product Code	Volume in ³
-----------------	-------------	--------------	------------------------

Single Gang Boxes

1/2	FSC10	077607	17.0
3/4	FSC15	077608	17.0
1/2	FS10	077601	17.5
3/4	FS15	077602	17.5
1/2	FSCC10	077622	16.3
3/4	FSCC15	077623	16.3
1/2	FSS10	077604	17.0
3/4	FSS15	077605	17.0

Note: 10 = 1/2" Hub, 15 = 3/4" Hub
 Outside Dimensions: Length, 4-9/16" - Width, 2-13/16" - Depth, 2"

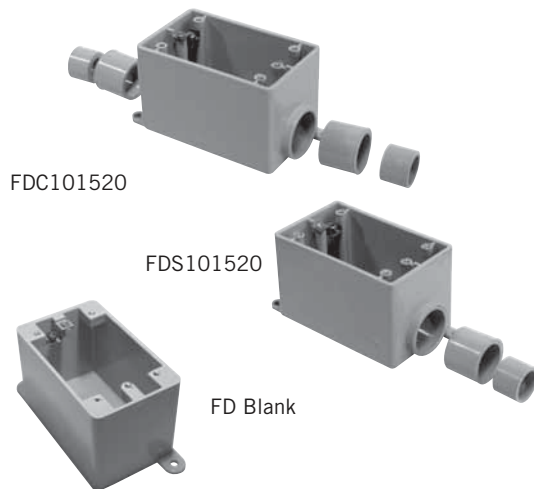

Hub Size inches	Part Number	Product Code	Volume in ³
-----------------	-------------	--------------	------------------------

Single Gang Deep Boxes

1/2, 3/4, 1	FDC101520	077291	26.0
1/2, 3/4, 1	FDS101520	077299	26.8
*BLANK	FD BLANK	077603	29.2
347 VOLT	FD347	077610	29.2

Note: 10 = 1/2" Hub, 15 = 3/4" Hub, 20 = 1" Hub
 Outside Dimensions: Height, 4 9/16" - Width, 2 13/16" - Depth 2 3/4",
 Cubic Inches = 35.30

* Not UL Listed

BOXES - F SERIES

Hub Size inches	Part Number	Product Code	OD (inches)			Volume (in ³)
			H	W	E	

Double Gang boxes

1/2, 3/4, 1	FS-2-101520-U	077364	4.62	4.62	2.5	38.5
1/2, 3/4, 1	FSC-2-101520-U	077368	4.62	4.62	2.5	37.0
1/2, 3/4, 1	FSS-2-101520-U	077372	4.62	4.62	2.5	37.0
1/2, 3/4, 1	FSCC-2-101520-U	077369	4.62	4.62	2.5	35.0
*Blank	FD-2-U	077649	4.75	4.75	3.0	47.5

* Not UL Listed

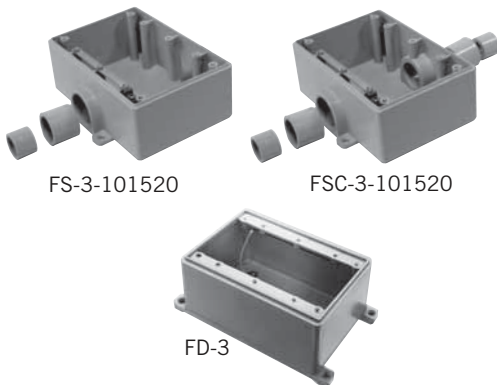
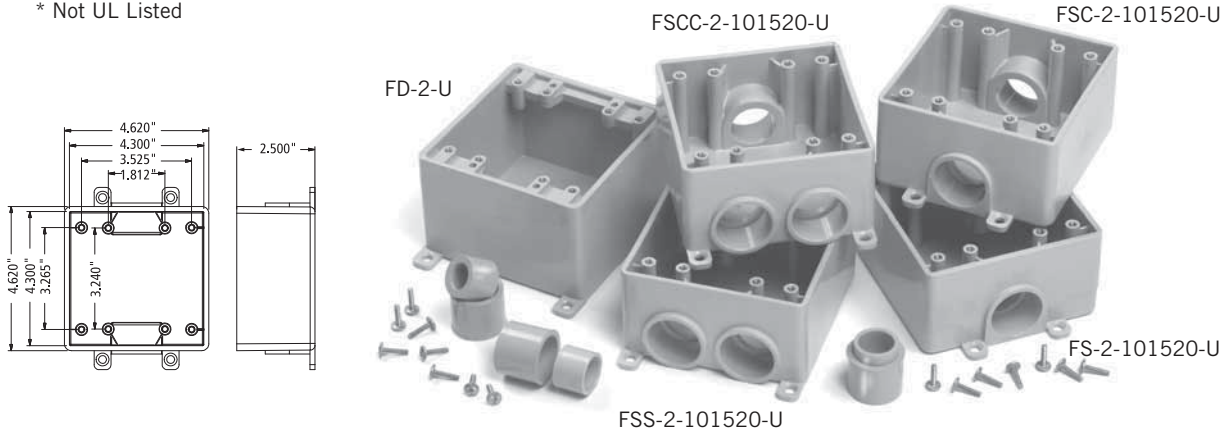

Hub Size inches	Part Number	Product Code	OD (inches)			Volume (in ³)
			H	W	E	

Triple Gang Boxes

1/2, 3/4, 1	FS-3-101520	077337	4.5	6.6	2.5	56.0
1/2, 3/4, 1	FSC-3-101520	077438	4.5	6.6	2.5	54.0
*Blank	FD-3	077737	4.5	6.6	3.0	73.8

* Not UL Listed

Octagonal Boxes are shipped complete with cover, gasket, 4 reducing bushings (3/4" x 1/2"), and 4 sealing caps to be installed from inside box to seal off unused entry hubs.

Size inches	Part Number	Hub Size inches	Product Code
-------------	-------------	-----------------	--------------

Octagonal Boxes*

4 x 1-1/2	OB15/10	1/2 - 3/4	077983*
4 x 2-1/8	OB20	1	077984*

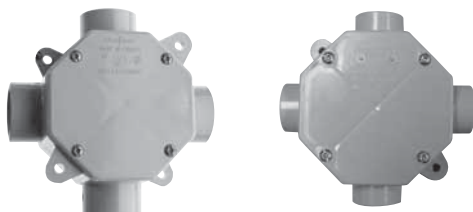

Size inches	Part Number	Product Code
-------------	-------------	--------------

Octagonal Box Extension Rings

4 x 1 deep	XR20	077989
4 x 2 deep	XR35	077990

Note: Octagonal Boxes are not designed for supporting light fixtures.



COVER PLATES - F SERIES

Description	Part Number	Product Code
-------------	-------------	--------------

Single Gang Plates

Duplex Receptacle	DRC15/10	077617
Toggle Switch	TSC15/10	077616
Single Receptacle	20RC15/10	077618
Single Receptacle	20-3RC15/10	077619
Single Receptacle	30-3RC15/10	077620
Blank c/w Gasket	BRC15/10	077611
PVC Gasket	GASK15/10	077621

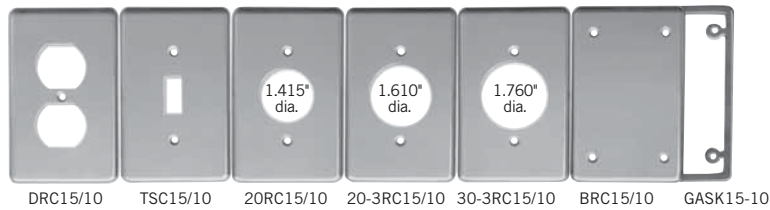

Double Gang Plates

Blank Cover c/w Gasket	BRC20-2-U	077359
Double Switch	TSC20-2-U	077373
Double Duplex Receptacle	DRC20-2-U	077362
Combo Switch Duplex Receptacle	TSDC20-2-U	077374
PVC Gasket	GASKFU20-2	172650

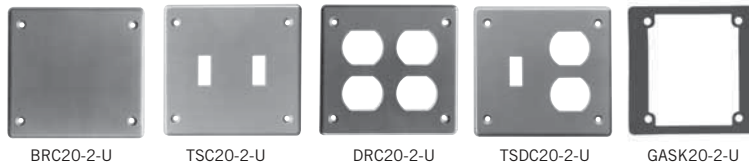

Triple Gang Plates

Triple Receptacle	DRC20-3	077747
Combo Switch Receptacle	DSDR20-3	077745
Triple Switch	TSC20-3	077744
Combo Switch Receptacle	TSDC20-3	077746
Blank Cover c/w Gasket	BRC20-3	077748
PVC Gasket	GASK20-3	077749



WEATHERPROOF COVERS

Manufactured with stainless steel return-springs/clips and packaged with brass screws, Scepter weatherproof covers provide a positive seal, even in cold temperatures.

Description	Device Opening (in)	Part Number	Product Code
Single Gang Weatherproof Covers			
Plunger-style Switch Cover		VPT15/10	077630
Toggle Switch Cover		VSC15/10	077612
Grey Toggle Switch Cover		WTG15/10	077606
Grey Duplex Receptacle		WDR15/10	077993
White Duplex Receptacle		RWDR15/10	077786
Grey Ground Fault Receptacle		WGF15/10	077785
White Ground Fault Receptacle		RWGF15/10	077787
Single Receptacle Device 15 AMP	1.375	WTL15	077992
Single Receptacle Device 20 AMP	1.625	WTL20	077994
Single Receptacle Device 30 AMP	1.722	WTL30	077991
Single Receptacle Device 50 AMP	2.187	WTL50	077951
Grey Double Door Duplex Receptacle		WDRE15/10	077087
White Double Door Duplex Receptacle		RWDRE15/10	077408
Gasket for W Series Cover (except WDRE & RWDRE)		GASKW	077755
Gasket for WDRE & RWDRE Covers		GASKDD	072225

Gaskets are included with all weatherproof covers.



Double Gang Weatherproof Covers

Toggle Switch Cover		VSCU20-2	077376
Combination Switch Cover & GFI Receptacle		VSRC20-2	077357
Combination Switch Cover & Duplex Receptacle		VSDRU20-2	077356
Double Door GFCI Cover		VSGG20-2	077096
Double Door Duplex Cover		VSDD20-2	077097
Gasket for Double Gang (except VSGG20-2 & VSDD20-2)		GASKFU20-2	172650
Gasket for VSGG20-2 and VSDD20-2 Double Gangs		GASKV20-2	072227

Gaskets are included with all weatherproof covers.

VSGG20-2 and VSDD20-2 are universal and will fit on most PVC and metal boxes.



JUNCTION BOXES

NEMA rated 1, 2, 3, 4, 4X, 6P, 12, 13 and UL approved for use in wet locations, Scepter PVC molded square **JUNCTION BOXES** are available in sizes from 4" x 4" x 2" to 12" x 12" x 8" and supplied with threaded brass screws and inserts, flexible PVC gaskets and external mounting feet. Nylon or stainless steel screws, as well as larger sizes are available on request.

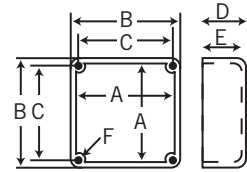

Part Number	Product Code	A inches	B inches	C inches	D inches	E inches	F inches	Volume (in. ³)
-------------	--------------	----------	----------	----------	----------	----------	----------	----------------------------

PVC Molded Junction Boxes

JB442	077659	3.675	4.000	3.450	2.125	2.000	8-32	26.5
JB444	077696	3.675	4.000	3.450	4.188	3.750	8-32	51.5
JB446	077669	3.675	4.000	3.450	6.225	6.000	8-32	78.0
JB552	077670	4.680	5.000	4.485	2.000	1.845	8-32	40.0
JB664	077697	6.000	6.375	5.813	4.188	4.000	10-32	138.0
JB666	077698	6.000	6.375	5.813	6.188	6.000	10-32	211.0
JB884	077664	8.075	8.625	7.966	4.230	4.005	1/4-20	434.0
JB887	077671	8.100	8.625	7.966	7.250	7.035	1/4-20	248.0
JB12124	077672	12.085	12.580	11.874	4.256	4.030	1/4-20	577.4
JB12126	077666	12.085	12.580	11.874	6.240	6.025	1/4-20	846.0
JB12128	077668	12.085	12.580	11.874	8.250	8.025	1/4-20	1102.0

Fabricated Boxes

Unflanged PVC fabricated boxes of any size may be made to customers' specifications and come complete with lids, gaskets and screws. These boxes are not UL Certified and are not returnable.

Description	Part Number	Product Code
-------------	-------------	--------------

Threaded Junction Boxes

	LFB150C	077250
	LFB150T *	077251

*LFB150T complete with 1/2 threaded" hole in center of cover



JUNCTION BOXES

Scepter's **FLANGED 'H' SERIES JUNCTION BOXES** provide H10 Highway Loading equivalent to handling a 50 psi load. The fiber-reinforced safety tread cover secures using recessed Hex Key fastening hardware offering a simple installation while reducing the opportunity for tampering.

Part Number	Product Code	Box ID (inches)			Lid Dimensions (inches)			Volume (in ³)
		L	W	D	A	B	C	

Flanged Box w Fire-reinforced Safety Tread Cover

H664	077685	6	6	4-1/4	9.0	9.0	0.60	138.0
H666	077686	6	6	6-1/4	9.0	9.0	0.60	211.0
H884	077687	8	8	4-1/4	11.5	11.5	0.75	248.0
H886	077688	8	8	6-1/4	11.5	11.5	0.75	434.0
H887	077689	8	8	7-1/4	11.5	11.5	0.75	434.0
H887-A	077692	8	8	7-1/4	11.5	11.5	0.75	434.0

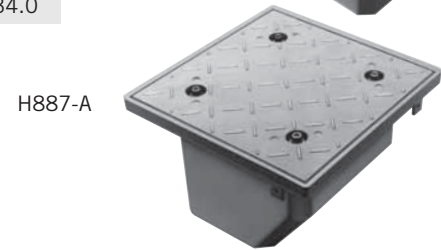
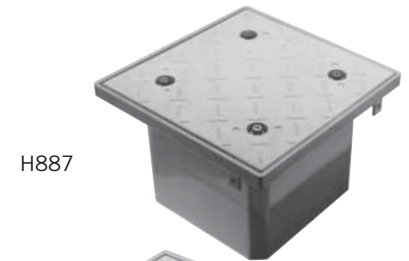
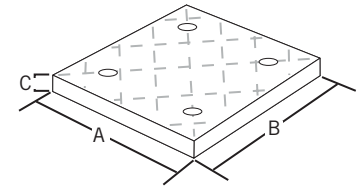

Size (inches)	Part Number	Product Code
---------------	-------------	--------------

Junction Box Adapters

1/2	JBA10	077721
3/4	JBA15	077722
1	JBA20	077723
1-1/4	JBA25	077724
1-1/2	JBA30	077725
2	JBA35	077726
2-1/2	JBA40	077727
3	JBA45	077728
3-1/2	JBA50	077729
4	JBA55	077730

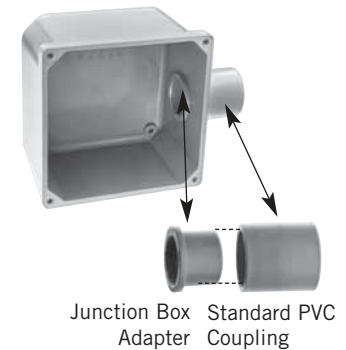

SCEPTER PVC ROUND FLOOR BOX

Suitable for slab-on-grade, below grade and wood floor construction, Scepter PVC round floor boxes and accessories enable contractors to collectively run in-floor power, data and communications wiring to a single box for significant savings in time and materials.

Installation is quick and simple, with our nonmetallic floor box and covers, saving both time and money over similar metallic assemblies.

Scepter's floor box and duplex receptacle covers are constructed from high impact, noncorroding and nonconducting PVC. The flush-mount covers are available in custom colors and are shipped with a levelling ring complete with a grounding clip. Metal cover adapter kits are also available, allowing you to adapt to metal floor plates. Our 6" deep floor box allows flexibility for various concrete floor pours, while our 4-3/4" width offers easy access and ample wire room. The box comes complete with two 1" and two 3/4" hub openings.

All boxes are shipped complete with reducer plugs for added versatility.

Complete technical information available at www.ipexamerica.com – Nonmetallic Floor Box & Accessories Technical Manual.



FB



FBS-KIT



AFMC



LRA-U



FBDRC



FBUDK



FBYC



Color	Description	Part Number	Product Code
	Floor Box Base (includes disposable protective cap and reducer plugs)	FB	076954
	Floor Box Base c/w Leveling Ring Adapter (includes disposable protective cap, reducer plugs and leveling ring adapter)	FBKIT	077068
	Floor Box Stand Kit (includes FB Box) (is equipped with several height brackets which accommodate the different rebar and post-tension cable heights and slab depths found from job-site to job-site.)	FBS-KIT	077700
	Metal Cover Adapter Kit (includes levelling ring, metal cover adapter and 2 gaskets)	AFMC	076953
	Universal Leveling Ring Adapter	LRA-U	076606
	Floor Box Duplex Receptacle Cover (Nonmetallic) (includes flush mount cover, blank cover & gasket)		
		Brown	FBDRCB 076955
		Gold	FBDRCG 076949
		Grey	FBDRCGr 076600
		Light Almond	FBDRCA 076605
	Tri-Service Universal Divider Kit (includes upper and lower dividers, riser tube and 2 grommets)	FBUDK	077948
	Y Connector (3/4")	FBYC	077499
	Brass Cover Plates (offers a one-piece design measuring 5-3/4" diameter. Are available in a variety of styles accommodating power (single or duplex receptacle) and communication needs. Install to the FB box using the universal leveling ring adapter.	DSC	178091
		DSC-P/C	178092
		SSC	178093
		SSC-P/C	178094
		DFL-1	178095
		DFL-2	178096

CEMENTS AND PRIMERS

Size	Part Number	Product Code
------	-------------	--------------

Conduit Cement c/w Applicator Cap except where indicated



250ml (1/2 Pint)	S100PT5	078883
500ml (Pint)	S100PT	078884
1L (Quart)	S100QT	078885
*4L (Gallon)	S100GAL	078887

Cold Weather / Wet Weather Cement

500ml (Pint)	CWC10	078503
1L (Quart)	CWC20	078886

Size inches	Part Number	Product Code
-------------	-------------	--------------

Primer



250ml (1/2 Pint)	C100PT5	078163
500ml (Pint)	C100PT	078174
1L (Quart)	C100QT	078175

AVERAGE # OF JOINTS PER PINT OR QUART OF CEMENT

Nominal Pipe Size inches	# of Joints per Pint	# of Joints per Quart	Nominal Pipe Size inches	# of Joints per Pint	# of Joints per Quart
1/2	350	700	2-1/2	40	80
3/4	200	400	3	35	70
1	150	300	3-1/2	30	60
1-1/4	110	220	4	24	48
1-1/2	80	160	5	10	20
2	45	90	6	8	16

Visit our website: www.ipexamerica.com



for our
ONLINE TRAINING
SOLVENT CEMENTING

You can take IPEX's training course, developed by leading experts in thermoplastic systems and offered through the IPEX Training Room.



SOLVENT CEMENTS ONLINE

SOLVENT CEMENTS ONLINE TEACHES YOU HOW TO SELECT THE RIGHT MATERIALS FOR THE JOB AND PRODUCE STRONG JOINTS UNDER A VARIETY OF CONDITIONS

INTERLOCKING SPACERS

IPEX's interlocking spacers provide uniform separation between the rows and columns of conduits and when assembled with conduit create a stable structure for the concrete. Spacers connect quickly and easily by sliding together horizontally and snapping together vertically and provide true customization for any configuration of duct bank. Superior features like the molded rebar slots for efficient drop-in installation of full length rebar and integral holes in base spacers for securing in place save time and effort.

RECOMMENDED DISTANCE: 6' - 7'

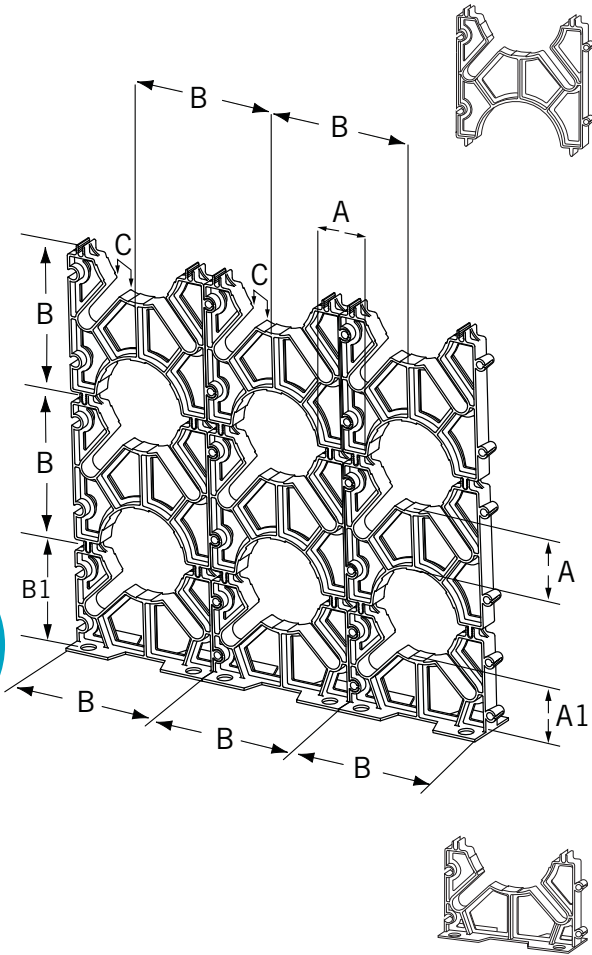
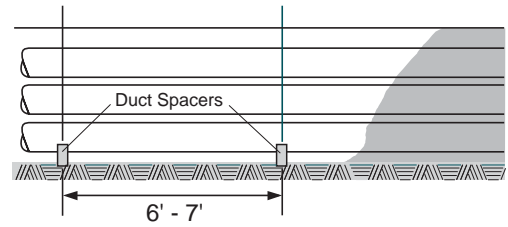

Dimension inches	Part Number	Product Code	Standard Pkg	A inches	B inches	C inches
------------------	-------------	--------------	--------------	----------	----------	----------

Intermediate Vertical-Lok Spacers

2 x 1-1/2	IS3530	029550	200	1.500	3.937	0.62
2 x 2	IS3535	029551	200	2.000	4.488	0.62
2 x 3	IS3545	029552	150	3.000	5.433	0.62
* 3 x 1-1/2	IS4530	029553	250	1.500	5.130	no rebar slots
3 x 2	IS4535	029554	100	2.000	5.630	0.87
3 x 3	IS4545	029555	160	3.000	6.614	0.87
* 4 x 1	IS5520	029556	250	1.000	5.630	no rebar slots
4 x 1-1/2	IS5530	029557	180	1.500	6.614	0.87
4 x 2	IS5535	029558	100	2.000	6.614	0.87
4 x 3	IS5545	029559	60	3.000	7.638	0.87
* 5 x 1-1/2	IS6030	029560	140	1.500	7.325	no rebar slots
5 x 2	IS6035	029561	60	2.188	7.874	0.87
5 x 3	IS6045	029562	60	3.188	8.701	0.87
6 x 1-1/2	IS6530	029563	100	1.500	7.441	0.87
6 x 2	IS6535	029564	100	2.000	7.677	0.87
6 x 3	IS6545	029565	40	3.000	9.764	0.87
* 8 x 2	IS8035	029294	60			no rebar slots

* Do not have rebar slots or base holes

Dimension inches	Part Number	Product Code	Standard Pkg	A1 inches	B1 inches	C1 inches
------------------	-------------	--------------	--------------	-----------	-----------	-----------

Base Vertical-Lok Spacers

2 x 1-1/2	BS3530	029566	150	2.992	3.937	0.62
2 x 2	BS3535	029567	150	2.992	4.488	0.62
2 x 3	BS3545	029568	100	2.992	5.433	0.62
* 3 x 1-1/2	BS4530	029569	250	3.000	4.615	no rebar slots
3 x 2	BS4535	029570	100	2.992	5.630	0.87
3 x 3	BS4545	029571	190	2.992	6.614	0.87
* 4 x 1	BS5520	029572	250	1.750	4.060	no rebar slots
4 x 1-1/2	BS5530	029573	180	2.992	6.614	0.87
4 x 2	BS5535	029574	80	2.992	6.614	0.87
4 x 3	BS5545	029575	60	2.992	7.638	0.87
* 5 x 1-1/2	BS6030	029576	140	3.000	6.900	no rebar slots
5 x 2	BS6035	029577	60	2.992	7.874	0.87
5 x 3	BS6045	029578	50	2.992	8.701	0.87
6 x 1-1/2	BS6530	029579	100	3.031	7.441	0.87
6 x 2	BS6535	029580	100	3.031	7.677	0.87
6 x 3	BS6545	029581	40	2.992	9.764	0.87
* 8 x 2	BS8035	029293	50			no rebar slots

* Do not have rebar slots or base holes

INEXO[®]

THE ICF BOX

Insertion depth of 2-1/4"

'TEETH' can be easily removed and replaced.

'TEETH' lock in place providing a rigid hold in the EPS foam.

Greater installation versatility with 3 screw hole choices and flanges on both sides.

Full flange prevents box from twisting and sinking into foam if over-tightened.

INEXO provides a 1/2" drywall setback resulting in a professional finish.

Single gang box provides 19 cubic inch capacity.



Scan to view our product demo video or visit our website

THE INNOVATIVE ELECTRICAL BOX FOR INSULATED CONCRETE FORM CONSTRUCTION



For complete product information, visit www.ipexamerica.com/inexo



Products manufactured by IPEX Electrical Inc. INEXO[™] is a trademark of IPEX Branding Inc.

Toll Free: 1-800-463-9572

➔ See page 52 for more information...

SCEPTALIGHT NONMETALLIC LIGHT FIXTURES



Whether you're looking for economical outdoor lighting solutions or corrosion-resistant fixtures for punishing industrial environments, Sceptalight fixtures from IPEX prove themselves to be all-round performers in a variety of indoor and outdoor applications.

Sceptalight fixtures are made from a glass-reinforced thermoplastic polyester resin, which offers outstanding corrosion and chemical resistance. And its interior and exterior silicone gaskets create a watertight seal, the reason it performs equally well indoors and outside. This thermoplastic design marries an unrivaled balance of strength, stiffness and toughness with all the benefits users appreciate of Scepter rigid PVC conduit and fittings – long life, easy servicing and high impact-resistance.

ADVANTAGES

- 1 Stable Construction**
Reinforced support feet offer secure mounting.
- 2 Adaptable**
Threaded conduit hubs permit connection to nonmetallic and metallic raceways.
- 3 Watertight Seal**
Temperature and weather-resistant silicone gaskets protect fixture from moisture penetration.
- 4 Long Life**
Sceptalight nonmetallic fixtures provide long life and easy servicing—unlike metal fixtures and guards that can corrode and seize together.
- 5 Indoor/Outdoor Use**
UV-resistant material makes Sceptalight fixtures suitable for both indoor and outdoor use.
- 6 Corrosion Resistant**
Thermoplastic construction resists attack from acids, alcohols, alkalis, organic solvents, detergents/ cleaners, greases and oils as well as many other types of chemicals.
Withstands exposure to direct sunlight, heat, salt water and extreme weather.
- 7 Durable, Impact Resistant**
High-impact nonmetallic guard resists physical impact, chemical attack and heat-induced deformation.

APPLICATIONS

- Chemical Plant
- Marine
- Food Processing
- Agricultural
- Highway Tunnel
- Waste Water
- Mine Tunnels
- Greenhouses
- Walk-in Freezers
- Industrial/Commercial

STANDARDS



Wet Locations

CSA C22.2 No. 250, UL 1598
Minimum 60°C supply conductors

Hazardous Locations

UL 844,
CLASS I, DIV 2 Groups A, B, C & D
CLASS II, DIV 2 Groups F & G
Minimum 90°C supply conductors

Marine Locations

CSA C22.2 No. 250, UL 1598, UL 1598A
Minimum 110°C supply conductors

DID YOU KNOW?

Explosive characteristics of gases, vapours or dusts vary with the specific material; it is therefore necessary that equipment installed within the hazardous location is identified for the specific group of gas, vapour or dust for which it is approved.



SHORT FORM SPECIFICATIONS

Light fixtures shall be nonmetallic and constructed of 30% glass filled polyester material exhibiting a maximum linear expansion of 1.4×10^{-5} in./in./°F. Fixtures shall be assembled with high temperature silicone gaskets, brass inserts and screws.

Incandescent light fixtures shall be rated for use with a Maximum 150 Watt incandescent lamp. Compact fluorescent light fixtures shall be of the wattage specified and be supplied complete with lamp and ballast (high power factor, low harmonic electronic for 18 & 26 Watt fixtures and magnetic for 7, 9 & 13 Watt fixtures).

Light fixtures shall be third-party certified to UL1598A for marine locations with salt water, UL1598 for indoor/outdoor wet location use and where the specified installation requires; Class I Div 2 and Class II Div 2 hazardous location use.

APPROVED PRODUCTS:

Sceptalight™ LVPF/LVPL/LVPE/LPMF/LPPL series light fixtures manufactured by IPEX.

PHOTOMETRIC DATA

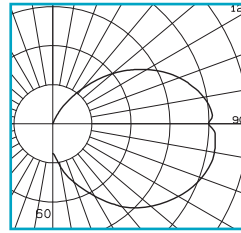

26W Quad Compact Fluorescent

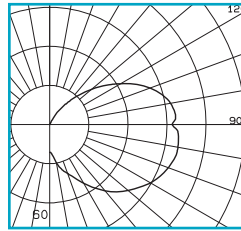

18W Quad Compact Fluorescent

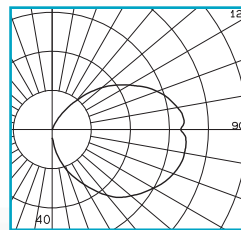

13W Twin-Tube Compact Fluorescent

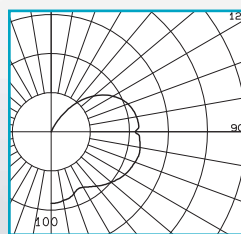

100W 120V Coated A19 Incandescent

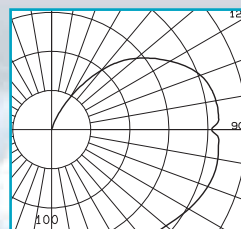

150W 120V Coated A21 Incandescent

For detailed technical and photometric information please consult our Technical Guide on our Website: www.ipexamerica.com.

MOUNTING OPTIONS



Ceiling Mount
Box with four 3/4" threaded hubs and integral mounting feet.



Wall Mount
Box with four 3/4" threaded hubs, 90° wall bracket and integral mounting feet.



Pendant Mount
Pendant cap with 3/4" threaded hub and a locking set screw.

GLOBE OPTIONS

Sceptalight offers a variety of globe options to suit a wide range of applications and environments. Our standard clear glass globes are ideal for general purpose area lighting for either indoor or outdoor use. Polycarbonate globes offer impact resistance in case of accidental contact and the assurance that work areas are not contaminated by broken glass.

Colored globes – available in red, blue, green or amber – can transform the light to an indicator or warning light.



Clear Polycarbonate



Standard or Heat-treated Clear Glass



Heat-treated Red Glass



Heat-treated Blue Glass



Heat-treated Green Glass



Heat-treated Amber Glass

LIGHT OPTIONS

Sceptalight offers the choice of energy-efficient compact fluorescents or cost-effective incandescents.

Fluorescents

Our compact fluorescent fixtures work four to five times more efficiently per watt than incandescents and provide 10-20 times the lamp life, yet use approximately 75% less energy. In this way, Sceptalight fluorescents lower energy and maintenance costs without sacrificing light levels.

Incandescents

With their low initial cost, Sceptalight incandescent fixtures make the most practical choice to meet the daily needs of commercial, industrial, marine and agricultural applications. Our incandescents are ideal for short burn times as well as flashing and dimming applications.

WET LOCATION USE



Description	Part Number	Product Code
-------------	-------------	--------------

C22.2 No. 250
UL 1598
Minimum 60°C supply conductors

Ceiling mount with standard clear glass globe

150 W Incandescent	LVPF150C	077225
150 W Incandescent (Less Guard)	LVPF150LG	077237
7 W Compact Fluorescent	LVPL7C	077120
9 W Compact Fluorescent	LVPL9C	077121
13 W Compact Fluorescent	LVPL13C	077122
18 W Compact Fluorescent	LVPL18C	077210
26 W Compact Fluorescent	LVPL26C	077170

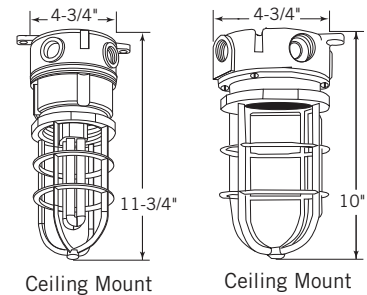

Ceiling mount with clear polycarbonate globe (no guard)

7 W Compact Fluorescent	LVPL7PCC	077145
9 W Compact Fluorescent	LVPL9PCC	077155
13 W Compact Fluorescent	LVPL13PCC	077165
18 W Compact Fluorescent	LVPL18PCC	077211
26 W Compact Fluorescent	LVPL26PCC	077176

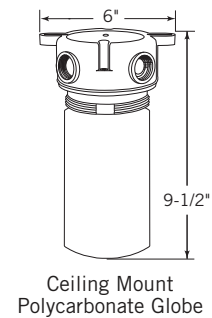

Pendant mount with standard clear glass globe

150 W Incandescent	LPMF150C	077231
7 W Compact Fluorescent	LPPL7C	077182
9 W Compact Fluorescent	LPPL9C	077183
13 W Compact Fluorescent	LPPL13C	077185
18 W Compact Fluorescent	LPPL18C	077212
26 W Compact Fluorescent	LPPL26C	077184

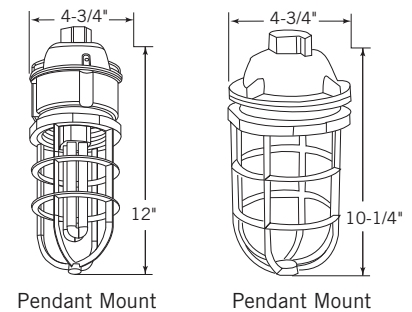

Pendant mount with clear polycarbonate globe (no guard)

7 W Compact Fluorescent	LPPL7PCC	077345
9 W Compact Fluorescent	LPPL9PCC	077355
13 W Compact Fluorescent	LPPL13PCC	077365
18 W Compact Fluorescent	LPPL18PCC	077273
26 W Compact Fluorescent	LPPL26PCC	077375

WET LOCATION USE CONT'D

Description	Part Number	Product Code
-------------	-------------	--------------

Utility Light - 150 Watt Incandescent (Ceiling Mount Only)

w/ Std. Glass Globe	LVPE150-10/15	077493
w/ Polycarbonate Globe	LVPE150-PCC*	077181
w/ Std. Glass Globe & Clamp-on Guard	LVPE150-1015G	077402
w/ H.R. Glass Globe Clear	LVPE150HRC	077578
w/ H.R. Glass Globe Red	LVPE150HRR	077599
w/ H.R. Glass Globe Blue	LVPE150HRB	077579
w/ H.R. Glass Globe Green	LVPE150HRG	077597
w/ H.R. Glass Globe Amber	LVPE150HRA	077598
Clamp-on Guard for LVPE	LVPU150	077558

* Maximum 60W incandescent lamp Type A

WET (UTILITY FIXTURE) LOCATION ONLY
Minimum 75°C supply conductors

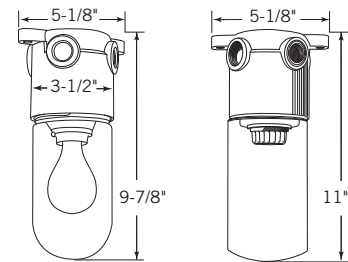

Ceiling Mount Utility Fixtures

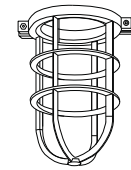

Clamp on Guard

HAZARDOUS LOCATION USE



Description	Part Number	Product Code
-------------	-------------	--------------

Ceiling mount with heat resistant glass globe

150 W Incandescent Clear	LVPF150HRC-HAZ	077414
150 W Incandescent Red	LVPF150HRR-HAZ	077415
150 W Incandescent Blue	LVPF150HRB-HAZ	077416
150 W Incandescent Green	LVPF150HRG-HAZ	077417
150 W Incandescent Amber	LVPF150HRG-HAZ	077494
18 W Compact Fluorescent Clear	LVPL18HRC-HAZ	077347
18 W Compact Fluorescent Red	LVPL18HRR-HAZ	077348
18 W Compact Fluorescent Blue	LVPL18HRB-HAZ	077349
18 W Compact Fluorescent Green	LVPL18HRG-HAZ	077353
18 W Compact Fluorescent Amber	LVPL18HRA-HAZ	077354
26 W Compact Fluorescent Clear	LVPL26HRC-HAZ	077377
26 W Compact Fluorescent Red	LVPL26HRR-HAZ	077378
26 W Compact Fluorescent Blue	LVPL26HRB-HAZ	077379
26 W Compact Fluorescent Green	LVPL26HRG-HAZ	077399
26 W Compact Fluorescent Amber	LVPL26HRA-HAZ	077400

Class I, DIV 2 Groups A,B,C & D
Class II, DIV 2 Groups F & G
Minimum 90°C supply conductors

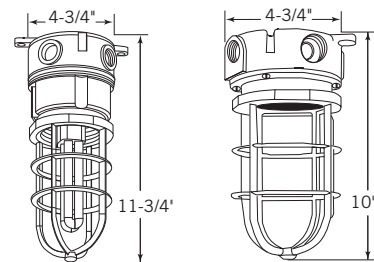

Ceiling Mount

Ceiling Mount

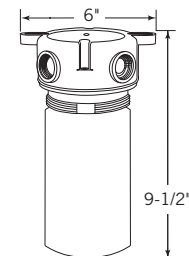

Ceiling Mount Polycarbonate Globe

Pendant mount with heat resistant glass globe

150 W Incandescent Clear	LPMF150HRC-HAZ	077495
150 W Incandescent Red	LPMF150HRR-HAZ	077496
18 W Compact Fluorescent Clear	LPPL18HRC-HAZ	077500
18 W Compact Fluorescent Red	LPPL18HRR-HAZ	077498
26 W Compact Fluorescent Clear	LPPL26HRC-HAZ	077407
26 W Compact Fluorescent Red	LPPL26HRR-HAZ	077409

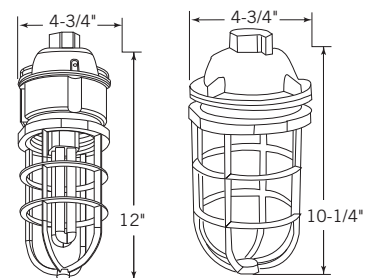

Pendant Mount

Pendant Mount

MARINE LOCATION USE



Description	Part Number	Product Code
-------------	-------------	--------------

Ceiling Mount w Standard Clear Glass Globe

100W Incandescent	LVPF100C-MAR	077275
-------------------	--------------	--------

Pendant Mount w Standard Clear Glass Globe

100W Incandescent	LVMF100C-MAR	077276
-------------------	--------------	--------

C22.2 No. 250
UL 1598, UL 1598A
Minimum 110°C supply conductors

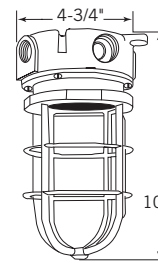

Ceiling Mount

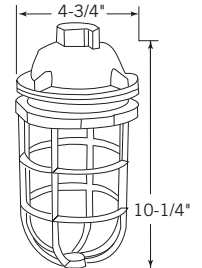

Pendant Mount

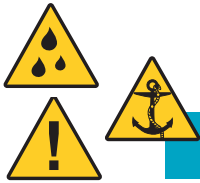

Description	Part Number	Product Code
-------------	-------------	--------------

Wall Mount

90° Wall Mount Bracket	LWB150	077233
------------------------	--------	--------

Note: For wall mount fixtures select the desired ceiling mount fixture from above and add LWB150 90° wall mount bracket.

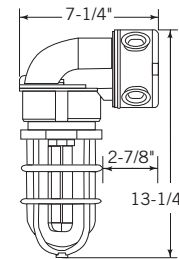

Wall Mount

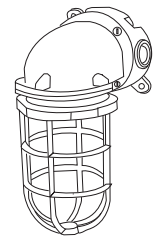

Wall Mount

ACCESSORIES & COMPONENTS

Description	Part Number	Product Code
-------------	-------------	--------------

Standard Glass Globes

Clear	LGC150	077247
-------	--------	--------



Heat Resistant Globes

Clear	LG150T	077909
Red	LCGR150T	077239
Blue	LCGB150T	077910
Green	LCGG150T	077241
Amber	LCGA150T	077242

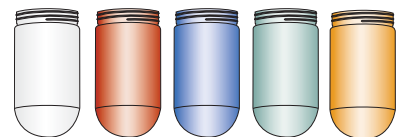

Polycarbonate Globes

Clear	LPCC18	077911
Red	LPCR18	077912
Blue	LPCB18	077913
Green	LPCG18	077914
Amber	LPCA18	077915

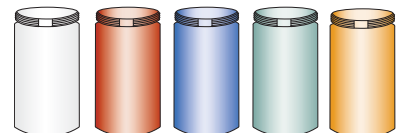

(for use with compact fluorescent or maximum 60W incandescent lamp)

ACCESSORIES & COMPONENTS CONT'D

Description	Part Number	Product Code
-------------	-------------	--------------

Fixture Components (LVPF, LVPL, LPMF, LPPL)

Ceiling Mount Box	LVPB 150	077243
Pendant Mount Cap	LPC 150	077246
90 Wall Bracket	LWB 150	077233
Socket Base Assembly	LSBA 150	077245
Medium Base Replacement Socket	LSOC 150	077249
Screw-on Guard	LVPG 150	077978

Replacement Lamps

7 Watt	LD/E 7	072841
9 Watt	LD/E 9	072844
13 Watt	LD/E 13	072847
18 Watt (Quad)	LD/E 18	077947
26 Watt (Quad)	LD/E 26	077081

Replacement Lamp Holders

7/9 Watt Lamp Holder	LLH 7/9	072843
13 Watt Lamp Holder	LLH 13	072849
18 Watt Lamp Holder (4 Pin)	LLH 18	072818
26 Watt Lamp Holder (4 Pin)	LLH 26	077082

Ballasts

7/9 Watt Magnetic Ballast (NPF)	LEB 7/9	072842
13 Watt Magnetic Ballast (NPF)	LEB 13	072848
18 Watt Electronic Ballast (HPF)	LEB 18	077224
26 Watt Electronic Ballast (HPF)	LEB 26	077080

Gaskets

Box Gasket	LBGASK 150	072820
Lamp Gasket	LLGASK 150	076971

Bookmark Our Website

www.ipexamerica.com



**PRODUCT INFO,
TECHNICAL
DOCUMENTS,
ONLINE TRAINING
& MUCH MORE ...**



OUR SCEPTER ELECTRICAL CATALOGUE & ELECTRICAL POCKET PRO INCLUDE MORE INFORMATION ON:

- Conduit & Fittings
- Light Fixtures
- ENT Tubing & Fittings
- Duct
- Trenchless Raceways
- and much more ...

available at www.ipexamerica.com

KWIKON ENT & FITTINGS

1/2" - 2" (12mm - 50mm)



Noncorroding and nonconducting Kwikon® Electrical Nonmetallic Tubing (ENT) fittings, slab boxes and accessories are engineered for the rugged day-to-day challenges of the construction industry - whether encased in concrete, concealed in walls or ceilings, or in direct burial applications.

Kwikon ENT's corrugated construction allows it to be bent easily by hand. No special bending equipment is required. And our patented Kwikon couplings and connectors, with their unique 360° locking tabs, provide for snap-on, lock-in installation that exceeds CSA and UL requirements for conduit pullout.

Add our innovative form stubbys and Kwikon concrete-tight slab boxes, (available with or without integral 1/2", 3/4" or 1" molded hub connectors) and you've got a total integrated system that saves you time and money on the job. Available in 1/2" to 2" sizes, Kwikon ENT is FT-4 rated for use in non-combustible construction.

APPLICATIONS

- Residential (low or high rise)
- Commercial (low or high rise)
- Institutional (Prisons, Schools, Universities)
- Hospitals and Nursing Homes
- Stadiums and Arenas

STANDARDS



CSA Standards C22.2 No. 227.1, C22.2 No. 85

NEMA TC-13

UL 514B, UL 514C, UL 1653

ADVANTAGES

- 1 Concrete-Tight**
Every contractor's worst nightmare is a product that doesn't work or hold up in poured concrete; the costs of replacement and repair can be tremendous. Kwikon ENT and fittings are concrete-tight, requiring no solvent welding or tape around the connections, or paper stuffed inside.
- 2 Pull Resistant**
Once a length of Kwikon tubing is connected to a coupling or connector, it stays connected, thanks to our unique six locking tab design. With a pull-out resistance of up to 175 lbs., our patented snap-on, lock-in system provides a seal that easily meets CSA requirements for conduit pullout.
- 3 Fire Resistant**
Kwikon ENT tubing, fittings and slab boxes are approved for use in noncombustible 2 hour and 4 hour fire-rated floor/ceiling assemblies.
- 4 Impact Resistant**
Kwikon ENT is made of impact resistant PVC, so it won't break or crack if an object is dropped on it or someone steps on it.
- 5 Strong Fittings**
Kwikon's strong, solid fittings meet all UL and CSA requirements.
- 6 Flexible**
Flexible enough to be bent by hand, Kwikon ENT is tough enough to withstand crushing and breaking.



DID YOU KNOW?

With its concrete-tight design and easy-to-install angled stubbies, Kwikon offers the perfect ENT solution for inslab floors.

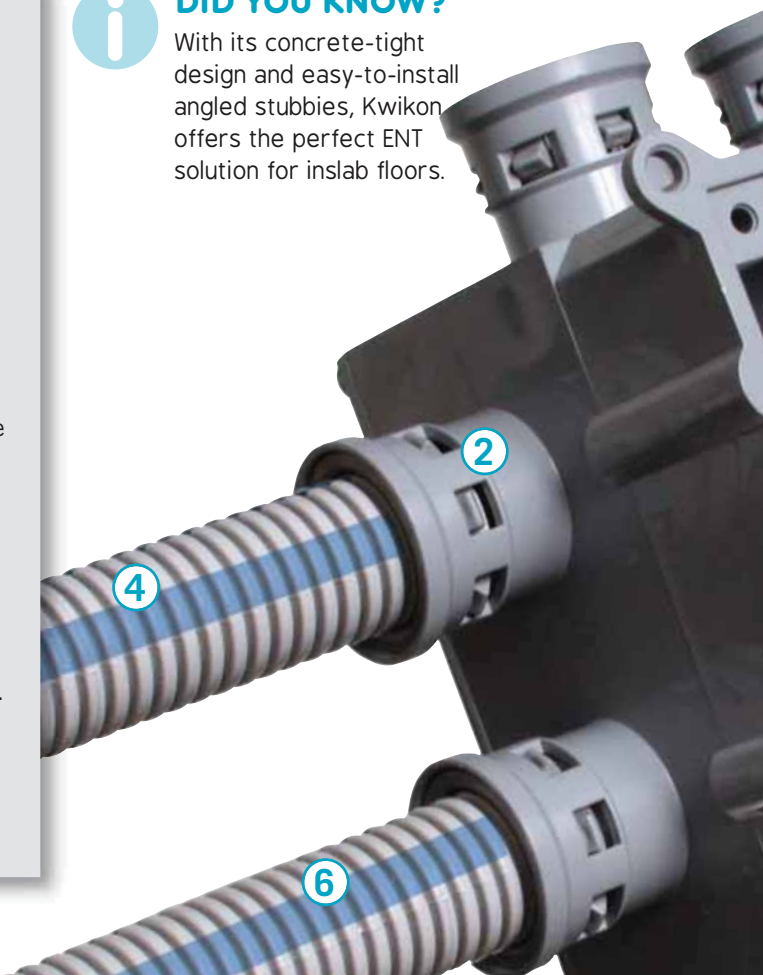

INSTALLING IS THIS EASY

1. Unroll Kwikon to desired length

Available in convenient coil and reel lengths up to 1,500 ft., Kwikon gives you the flexibility to measure out exactly the amount of tubing you need. Kwikon requires fewer couplings for long spans than metal conduit. It's recommended ENT be securely fastened at 2 – 3 ft. intervals.

2. Cut Kwikon with an Ent Cutter

For straight cuts every time use the Kwikon scissor-style cutting tool. However, no special tools or cutting equipment are necessary. Kwikon can even be cut with a standard utility knife.

3. Make bends and turns by hand

Unlike metal which has to be cut to fit tight spaces, Kwikon can be bent, turned and manipulated by hand to wind around irregular curves and corners. When bending, ensure the radius of the curve is at least six times the diameter of the tubing.

4. Simply snap connections together

With no special tools or equipment needed, Kwikon's unique snap-on fittings quickly and easily join or terminate Kwikon ENT and provide a concrete-tight connection.

5. Pull Cable through Kwikon

Kwikon's interior corrugated surface significantly reduces the amount of friction when pulling cables through long runs, even in runs with 90° bends. With Kwikon, you can pull longer runs of cable without worrying about damage.



SHORT FORM SPECIFICATIONS

GENERAL

1.1 References

- A. Standards referred to in this section are:
 1. UL 1653 Electrical Nonmetallic Tubing.
 2. NEMA TC-13 Electrical Nonmetallic Tubing.

PRODUCTS

2.1 Manufacturers

- A. Acceptable manufacturers are listed below
 1. Electrical Nonmetallic Tubing: a. Kwikon by IPEX
 2. Electrical Nonmetallic Tubing Fittings: a. Kwikon by IPEX
 3. Electrical Nonmetallic Tubing Boxes: a. Kwikon by IPEX
- B. All ENT tubing, ENT fittings, ENT boxes and accessories shall be manufactured by the same company so as to form a complete ENT system.
- C. ENT systems shall be approved for use in fire resistance rated concrete floor-ceiling assemblies with fire resistance ratings up to 4 hours.

2.2 Raceways

- A. ENT raceway shall be color coded to indicate the wiring system. Blue stripe for power, red stripe for fire alarm/emergency systems and yellow stripe for data/communications.
- B. ENT raceway shall be listed to UL 1653 and manufactured in accordance with NEMA TC-13.

2.3 Fittings

- A. ENT Fittings shall be manufactured of high-impact PVC,
- B. ENT Fittings shall meet the following requirements:
 1. Six locking tabs located every 60° providing 360° contact.
 2. Locking tabs shall provide a conduit pullout of a minimum 175 ft-lb force.
 3. Concrete tight without the need for taping.
 4. When transitioning to EMT conduit, the transition fitting shall have six locking tabs for ENT connection and set-screw connection for EMT.

2.4 Boxes

- A. ENT boxes shall be manufactured of high-impact PVC,
- B. ENT Slab Box and Wall Box requirements:
 1. Slab Boxes shall be approved for the purpose and concrete-tight.
 2. Round Slab Boxes shall be approved for use with luminaires up to 50 lbs and ceiling fans up to 35 lbs.
 3. Round Slab Boxes shall have threaded brass inserts for the attachment of luminaires or ceiling fans.
 4. Slab Boxes shall have eight (8) integrally molded ENT hub connectors with six locking tabs for ENT raceway connection.

INSTALLATION

3.1 Installation

- A. ENT raceways, fittings, boxes and accessories shall be installed in accordance with Article 362 of the 2008 National Electrical Code.
- B. Where ENT penetrates a fire-rated wall, floor or ceiling assembly, an approved firestop system as listed in Underwriters Laboratories Building Materials Directory or other nationally recognized testing laboratory shall be used.
- C. Not permitted for use where subject to ambient temperatures in excess of 122°F (50°C)

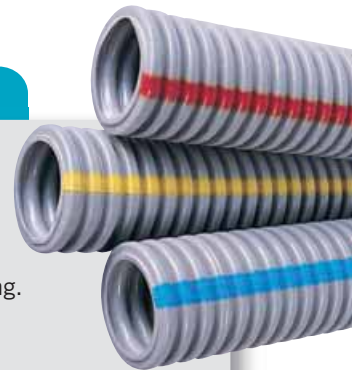

KWIKON ENT

Size inches	ID inches	OD inches	Length feet	Product Code
-------------	-----------	-----------	-------------	--------------

Kwikon ENT Coils – Blue Stripe



1/2	0.574	0.840	200	012031
3/4	0.778	1.050	100	012040
1	1.000	1.315	100	012041
1-1/4	1.340	1.660	500	012046
1-1/2	1.610	1.900	300	012032
2	2.020	2.375	225	012043

Kwikon ENT Reels – Blue Stripe



1/2	0.574	0.840	1500	012002
3/4	0.778	1.050	1000	012011
1	1.000	1.315	750	012021
1-1/4	1.345	1.660	1000	012047
1-1/2	1.610	1.900	750	012033
2	2.020	2.375	500	012044

Size inches	Length feet	Product Code	Crate Size
-------------	-------------	--------------	------------

Kwikon ENT 10' Sticks – Blue Stripe



1/2	10	012001	3600
3/4	10	012010	2200
1	10	012034	1800

Size inches	Length feet	Product Code	
		Red	Yellow

Kwikon ENT Reels – Color Coded



1/2	1500	012305	12335
3/4	1000	012307	12337
1	750	012310	12340

Note: 1-1/4", 1-1/2", 2" red and yellow stripe ENT is available by special order.

Storage of Kwikon ENT Tubing

Manufacturer recommends that ENT tubing should not be stored outdoors where subjected to direct sunlight without protective covering, i.e. packaging or tarps.

KWIKON FITTINGS

Size inches	Part Number	Product Code
-------------	-------------	--------------

Kwikon Couplings



1/2	KC10	089000
3/4	KC15	089001
1	KC20	089002
1-1/4	KC25	189670
1-1/2	KC30	189671
2	KC35	189672

Kwikon Snap-in Connectors



1/2	KTS10	089146
3/4	KTS15	089147
1	KTS20	089148

Kwikon Connectors*



1/2	KTA10	089006
3/4	KTA15	089007
1	KTA20	089008
1-1/4	KTA25	189680
1-1/2	KTA30	189681
2	KTA35	189682

*KTA connectors are supplied with locknuts.

Kwikon Transition Couplings



1/2	KTC10	089012
3/4	KTC15	089013
1	KTC20	089014

KWIKON FITTINGS

KWIKON ENT FORM STUBBIES create conduit stub-downs in concrete without needing to drill holes in the plywood form. Available in the original stubby design, the angled version and the Multi-Link, Kwikon form stubbies also protect the ENT from potential damage during the removal of wood forms.

Size inches	Part Number	Product Code
-------------	-------------	--------------

Kwikon ENT Form Stubbies



1/2	KSTB-10	089330
3/4	KSTB-15	089331
1	KSTB-20	089332
1-1/4	KSTB-25	089333

The **KWIKON ENT ANGLED FORM STUBBY** gives you the advantage of positioning the ENT at a lower profile within the slab.

Size inches	Part Number	Product Code
-------------	-------------	--------------

Kwikon ENT Angled Form Stubbies



1/2	KASTB-10	089233
3/4	KASTB-15	089234
1	KASTB-20	089235
1-1/4	KASTB-25	089236
1-1/2	KASTB-30	089238

The **KWIKON ENT MULTI-LINK FORM STUBBY** features a snap-together design which enables them to be configured in a variety of tightly grouped formations. It also features a thin removable film over the drop opening.

Size inches	Part Number	Product Code
-------------	-------------	--------------

Kwikon ENT Multi-Link Form Stubbies



1/2	MSTB-10	089031
3/4	MSTB-15	089026
1	MSTB-20	089025

KWIKON STUB DOWN FITTINGS are designed for direct connection to ENT on the horizontal. The flanged base offers a NPSC threaded hub connection on the vertical (at the exit point of the slab) allowing for the direct transition to other raceway products or to ENT connection.

Either way, our Kwikon ENT connection creates a stub down of ENT without penetrating the form.

Designed to offer the optimal balance of bend radius and overall height in the slab, these fittings provide a bend radius of 2-1/2" while standing less than 3-3/8" tall.

Size inches	Part Number	Product Code
-------------	-------------	--------------

Kwikon (KT90) Stub Down Fittings (Kwikon x Threaded)

1/2	KT90-10	089060
3/4	KT90-15	089059
1	KT90-20	089058



Kwikon (KK90) Stub Down Fittings (Kwikon x Kwikon)

1/2	KK90-10	089055
3/4	KK90-15	089056
1	KK90-20	089057



The **NEW ENT SUPPORT UNIT (ESU)** raises the tubing or conduit up off the concrete form during the concrete pour maintaining a level raceway and allows for maximum aggregate flow and concrete consolidation.

Easy to use, the ESU snaps around any size of ENT. It is perfect for use in high rise buildings constructed with post-tensioned (PT) concrete slabs.

FEATURES

- One size fits all 1/2" - 2"
- Saves time and labour
- Easy locking mechanism
- Securable to the concrete form
- Minimal footprint reduces amount of surface contact

Part Number	Product Code
-------------	--------------

ENT support unit (ESU)

ESU-10-35	089149
-----------	--------



KWIKON SLAB BOXES

STANDARD SLAB BOXES

- Approved for support of ceiling fans up to 35 lbs. and luminaires up to 50 lbs.
- Concrete-tight.
- Corner and traditional mounting tabs offer contractors two options when installing to the slab deck
- Angled design guides the nail into position within the trim cover area
- All molded connectors have 360° locking tabs that exceed UL and CSA requirements for pull-out.
- Manufactured from high-impact PVC.
- Nonmetallic/non-conducting/non-corroding.
- Threaded brass inserts. (10/32 for ceiling fans, 8/32 for luminaires).
- Supplied as a fully assembled one piece unit.
- Clear Vue vacuum formed removable covers

Size inches	Part Number	Product Code
-------------	-------------	--------------

Kwikon Standard Slab Boxes

with Molded Connectors – Volume 44 cu in.



8 x 1/2	SMB-H-10	089465
8 x 3/4	SMB-H-15	089462
4 x 1/2, 4 x 3/4	SMB-H-10/15	089458
4 x 1/2, 2 x 3/4, 2 x 1	SMB-H-10/20	089466
4 x 3/4, 4 x 1	SMB-H-15/20	089464

Kwikon Standard Slab Boxes with Knockouts

(without Molded Connectors) – Volume 44 cu in.



8 x 1/2	SMB-10	089460
4 x 1/2, 2 x 3/4, 2 x 1	SMB-10/20	089461

SHALLOW SLAB BOXES

- Threaded brass inserts (10/32 for ceiling fans, 8/32 for luminaires).
- Approval for support of ceiling fans up to 35 lbs and luminaires up to 50 lbs.
- Overall height of box (2-7/8") allows for use in thinner slabs.
- Clear Vue vacuum formed removable covers

Size inches	Part Number	Product Code
-------------	-------------	--------------

Kwikon Shallow Slab Boxes

with Molded Connectors – Volume 36 cu in.



8 x 1/2	SMBS-H-10	089480
8 x 3/4	SMBS-H-15	089482
4 x 1/2, 4 x 3/4	SMBS-H-10/15	089481
4 x 1/2, 2 x 3/4, 2 x 1	SMBS-H-10/20	089483
4 x 3/4, 4 x 1	SMBS-H-15/20	089484

Kwikon Shallow Slab Boxes with Knockouts

(without Molded Connectors) – Volume 36 cu in.

8 x 1/2	SMBS-10	089490
4 x 1/2, 2 x 3/4, 2 x 1	SMBS-10/20	089491

EXTENSION RING

- Easily installed.
- Quickly adjusts to new height.

Size inches	Part Number	Product Code
-------------	-------------	--------------

Kwikon Slab Box Extension Ring

SMBR 089494

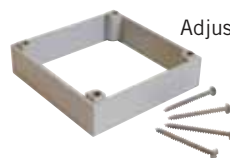

Adjusts height of SMB/SMBH series slab boxes by 1"

SQUARE SLAB BOXES

- Direct mounting of 4" devices and 4" square covers.
- Mounting feet are located on corners for quicker positioning and securing to form.
- Standard dimension 2-gang cover plates cover all exposed surfaces.
- Clear Vue vacuum formed removable covers

Size inches	Part Number	Product Code
-------------	-------------	--------------

Kwikon Square Slab Boxes

with Molded Connectors – Volume 44 cu in.



8 x 1/2	SSBH-10	089467
8 x 3/4	SSBH-15	089468
4 x 1/2, 4 x 3/4	SSBH-10/15	089469
4 x 1/2, 2 x 3/4, 2 x 1	SSBH-10/20	089474
4 x 3/4, 4 x 1	SSBH-15/20	089475

CONCRETE WALL BOXES

- Fully assembled and installation ready
- Perfectly suited for deep or shallow construction preferences
- Kwikon hubs do not protrude inside the box
- Clear Vue vacuum formed removable covers

Size inches	Part Number	Product Code
-------------	-------------	--------------

Kwikon Concrete Wall Boxes

3-1/2" Deep Boxes



4 x 1/2, 4 x 3/4	SVDB-H-10/15	089496
4 x 3/4, 4 x 1	SVDB-H-15/20	089049
4 x 1/2, 2 x 3/4, 2 x 1	SVDB-H-10/20	089052
8 x 3/4	SVDB-H-15	089065

Kwikon Shallow Concrete Wall Boxes

2" Shallow Boxes



4 x 1/2	SVSB-H-10	089054
4 x 3/4	SVSB-H-15	089053

SLAB BOX ASSEMBLY FOR USE WITH PLASTER RINGS

- Approved for support of ceiling fans up to 35 lbs. and luminaries up to 50 lbs.
- Slab box assemblies are supplied without the collar - ready to accept the desired raised cover/plaster ring.
- Plaster rings mount directly to the box opening using the screws supplied.
- Used with raised covers, boxes are perfect for use in shear wall or block construction for wall mounted fixtures and devices.
- Clear Vue vacuum formed removable covers

Size inches	Part Number	Product Code
-------------	-------------	--------------

Kwikon Slab Boxes

with Molded Connectors



8 x 1/2	MBH-10	089022
8 x 3/4	MBH-15	089018
4 x 1/2, 4 x 3/4	MBH-10/15	089020
4 x 1/2, 2 x 3/4, 2 x 1	MBH-10/20	089019
4 x 3/4, 4 x 1	MBH-15/20	089021

Kwikon Slab Boxes with Knockouts

(without Molded Connectors) – Volume 36 cu in.

8 x 1/2	MB-10	089017
4 x 1/2, 2 x 3/4, 2 x 1	MB-10/20	089016

FLOOR BOX STAND KIT

Is equipped with several height brackets which accommodate the different rebar and post-tension cable heights and slab depths found from job-site to job-site.

Part Number	Product Code
-------------	--------------

Floor Box Stand Kit includes FB Box

FBS-KIT 077700



For full product selection see page 32

IN WALL BOXES

Description	Part Number	Product Code
ENT Wall Boxes, Ceiling Boxes, Plaster rings & Covers		
Ceiling Box 2-1/16" Deep	KCB-10	089506
4" Set-Up Box 2-1/16" Deep	KDCB-10/15	089507
Switch Box 3-1/16" Deep	KSB-10/15	089508
4" Square Box 1-1/2" Deep	KDSB-2-10	089509
4" Square Box 2-1/8" Deep	KDSB-2-10/15	089510
Raised 1/2" Single Device	KRC-10	089501
Raised 5/8" Single Device	KRC-15	089502
Raised 1/2" Two Devices	KRCD-2-10	089503
Raised 5/8" Two Devices	KRCD-2-15	089504
Round Flat Cover, 1/2" KO	KFC-10	089505
Square Flat Cover, 1/2" KO	KWBC-10	089500
Voltage Partition	KVP	089512

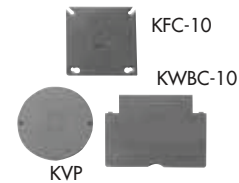
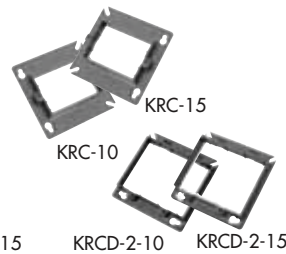
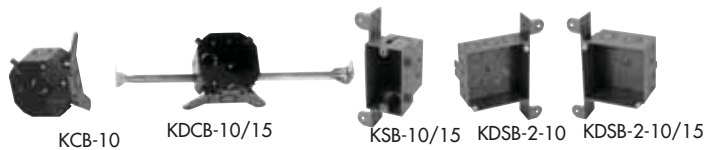

ACCESSORIES

Description	Part Number	Product Code
Cutting Tool		
Cutting Tool 1/2" – 1"	CLC20	988210
Cutting Tool 1/2" – 2"	CLC35	988915
Replacement Blade for CLC20	SSB	988211
Replacement Blade for CLC35	SB35	988916



One Kit, Four Heights, One Low Cost!



This simple yet innovative **Round Floor Box Stand** is equipped with several height brackets which accommodate the different rebar and post-tension cable heights and slab depths found from job-site to job-site. When installed together, the Floor Box and Stand can be used in 5-1/2" to 10" slab depths.

Sold as a Kit, IPEX offers the Round Floor Box and Stand conveniently packaged together as one complete product offering.

FEATURE & BENEFITS

- Four Adjustable Heights
- Raises Entrance Hubs to Rebar
- Minimizes Footprint on Concrete Form
- Withstands Tough Job Site Conditions
- Easy to Install
- Cost Effective

For more information, visit our website www.ipexamerica.com

Dual Mounting System from Kwikon



Slab Box Installation Made Easy

Designed to withstand tough jobsite environments, Kwikon® ENT slab boxes are nonmetallic, nonconductive and noncorroding. All Deep Round Series slab boxes feature our new CORNER MOUNTING TABS. These uniquely positioned corner tabs allow contractors to easily nail Kwikon slab boxes to the slab deck. The angled design guides the nail to be positioned inside the fixture's trim cover, reducing the threat of visible rust bleeding through the finished ceiling.

- Approved for support of ceiling fans up to 35 lbs and luminaries up to 50 lbs
- Corner and traditional mounting tabs offer contractors two options when installing to the slab deck
- Angled design guides the nail into position within the trim cover area
- Ready to install – no assembly required
- Clear Vue vacuum formed removable covers

Toll Free: 800-463-9572 | www.ipexamerica.com



Products are manufactured by IPEX Electrical Inc. and distributed in the United States by IPEX USA LLC.

INEXO ICF BOXES

1/2", 3/4", 1" (12mm, 19mm, 25mm)

INEXO™

Until now there have been few choices when attempting to provide a truly professional electrical box solution for Insulated Concrete Form homes. Traditional electrical boxes are tedious to install and often require a fair amount of ingenuity and additional labour to provide a less than ideal finished product. Other boxes offered to ICF builders require installation before the concrete pour, throwing off your project time-line.

INEXO's patented¹ design provides a truly professional solution that works with your production schedule and provides the quality installation and finished look that builders require and owners appreciate. INEXO boxes link seamlessly with existing ICF materials, tools and methods. A complete offering designed for ICF walls allow builders to standardize on the use of electrical boxes throughout the building.

¹ Patent No. 6,932,628 & Patent Pending

APPLICATIONS

- Insulated Concrete Form Buildings
- Schools
- Churches
- Hotels

STANDARDS



ADVANTAGES

- 1 Installation after concrete pour allows you to follow traditional production schedules**
- 2 Positioning** – Boxes can be installed anywhere on the ICF wall allowing for more variety in box positioning as installers are no longer required to affix to the ICF ties or drill and secure to the concrete wall.
- 3 Availability** – Residential boxes are available in single, double and triple gang options.
- 4 Certification** – Boxes are fully CSA certified to UL standards for use in ICF and can resist pull forces exceeding 100 lbs – (twice the standard requirement).

FAST AND EASY INSTALLATION

Installing INEXO boxes requires no special training making the transition to a new solution seamless.

STEP 1:

Select the position for your box. Using a hot-knife or cutting tool, cut the opening in the EPS foam.



STEP 2:

Insert the INEXO box into your opening and push the 'teeth' into place until you hear the 'click' – so you know your box is secure. If you are positioned next to a tie, you can utilize two of the 'teeth' on the non-tie side and use the flange holes on the opposite side to screw into the plastic tie.



STEP 3:

Pull through your NMD cable and continue.



Single gang box provides 19 cubic inch capacity

INEXO provides a 1/2" drywall setback resulting in a professional finish.

With an insertion depth of 2-1/4" and a smooth back, the INEXO box is designed specifically for ICF.

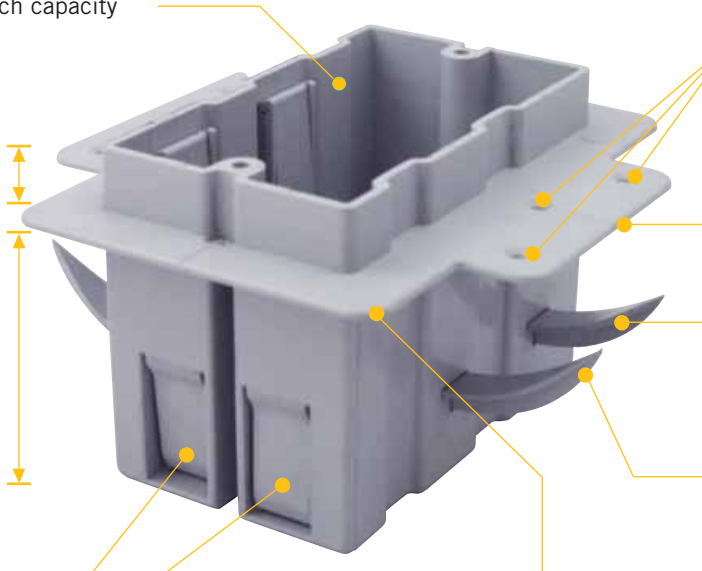

Greater installation versatility with 3 screw hole choices and flanges on both sides.

Laser level guides for the most precise box placement

'TEETH' can be easily removed and replaced and provide an audible 'click' when fully engaged and secured to the EPS foam.

'TEETH' lock in place for a rigid hold that won't loosen.



Full flange prevents box from twisting and sinking into foam if over-tightened. This innovation allows installers to provide a professional straight finish with no lop-sided boxes.

RESIDENTIAL BOX DESIGNED FOR NMD CABLE (14/2 – 10/3).

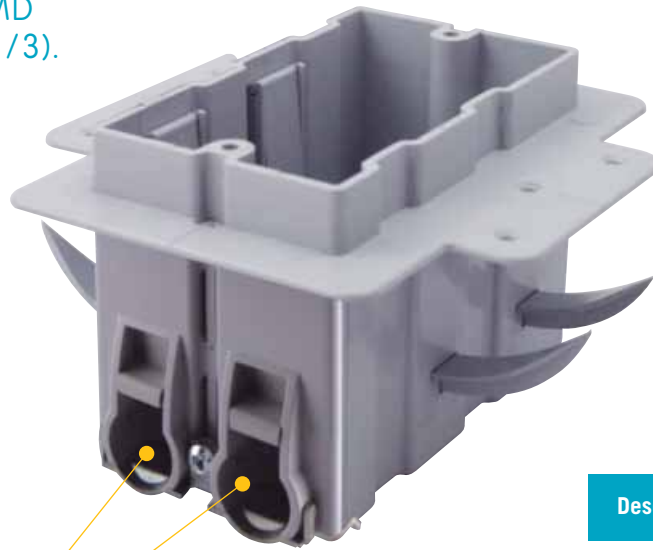

COMMERCIAL BOX DESIGNED FOR ARMoured CABLE (AC) OR NMD CABLE.

Description	Part Number	Product Code
-------------	-------------	--------------

Residential (NMD Cable 14/2 – 10/3)

 Single Gang	ICF-1-RL	220000
Double Gang	ICF-2-RL	220001
Triple Gang	ICF-3-RL	220002

Commercial (AC or NMD Cable)

 Single Gang	ICF-1-CLU	220009
Double Gang	ICF-2-CLU	220010
Triple Gang	ICF-3-CLU	220011

KWIKFLEX LIQUIDTIGHT FLEXIBLE NONMETALLIC CONDUIT & FITTINGS



Available in sizes from 3/8" to 2", reels offer the end user the best possible continuous length in the market place. Its patented design offers a low profile coupling that when two conduits are connected it is hardly noticeable and allows the user to run the conduit at any length desirable. There is no longer any need for additional parts when making a long conduit run.

Kwikflex NMLT is also available in extra-flexible formulations in sizes 3/8" to 2"

Coils are conveniently packaged in cardboard boxes to keep the pipe clean and come with a center knock-out for easy dispensing.

Kwikflex fittings are available in a full range of matching sizes in straight, 90 degree and in a NEW multi-angle configuration. The new Multi-Angle Conduit Connector features a unique swivel design which allows for:

- Multiple angle installations
- 45 degree installations
- The ultimate in flexibility for your job

APPLICATIONS

- HVAC Equipment
- Marine Equipment
- Motors & Controls
- Printing Equipment
- Refrigeration Equipment
- Transformer Connections
- Machine Tools
- Pumps
- Outdoor Lighting

STANDARDS



UL 1660



CSA C22.2 No. 227.2

ADVANTAGES

- 1 • Quick installation
- 2 • Lower installed cost
- 3 • Smooth interior surface
- 4 • Gradual sweep
- 5 • No sharp edges
- 6 • Quicker and easier wire pulling and pushing
- 7 • Won't rust or corrode
- 8 • All fittings are UL Listed and CSA Certified
- 9 • Positive grip
- 10 • Liquidtight and Oiltight
- 11 • Suitable for wet and damp locations
- 12 • Provides a liquidtight seal at knockout hole, comes with locknut and sealing o-ring



NMLT CONDUIT

Size inches	Product Code	Length feet
-------------	--------------	-------------

NMLT Flexible Conduit (Grey) Type B



3/8	165005	100
1/2	165007	100
3/4	165009	100
1	165011	100
1-1/4	165014	100
1-1/2	165017	50
1-1/2	165021	100
2	165020	50

NMLT Flexible Conduit Reels (Grey) Type B



1/2	165082	1000
3/4	165085	700
1	165090	500

Size inches	Part Number	Product Code
-------------	-------------	--------------

NMLT Extra Flexible Tubing (Black)



3/8	165055	100
1/2	165057	100
3/4	165059	100
1	165061	100
1-1/4	165064	100
1-1/2	165067	100
2	165070	100

Other packages sizes available on request

NMLT FITTINGS

Size inches	Product Code	Length feet
-------------	--------------	-------------

NMLT 90° Elbows (Grey)



3/8	LTB03/90	065306
1/2	LTB10/90	065307
3/4	LTB15/90	065310
1	LTB20/90	065312
1-1/4	LTB25/90	065314
1-1/2	LTB30/90	065317
2	LTB35/90	065320

NMLT Straight Fittings (Grey)



3/8	LTS03	065326
1/2	LTS10	065327
3/4	LTS15	065330
1	LTS20	065332
1-1/4	LTS25	065334
1-1/2	LTS30	065337
2	LTS35	065340

Size inches	Part Number	Product Code
-------------	-------------	--------------

NMLT Screw-on 90° Elbows (Grey)



1/2	LTD10/90	065350
3/4	LTD15/90	065352

NMLT Screw-on Straight Fittings (Grey)



1/2	LTD10	065360
3/4	LTD15	065362

NMLT Screw-on Multi Angle Fittings (Grey)



1/2	LTMA10	065015
3/4	LTMA15	065016

EPR REPAIR KITS

1-1/4" - 6" (30mm - 150mm)

EPR KITS

These clever and innovative conduit repair kits from IPEX are the first total repair systems for broken and damaged PVC conduit. They offer fast and easy repairs for damaged conduit caused by actions such as earth excavation, horizontal and core drilling.

With unique interlocking joints, the EPR Kits' two half shell bell by bell pieces simply close around the installed wire and cable. Using standard PVC solvent cement, EPR Kits are quickly and easily assembled and connected, restoring the conduit to its original form. And, unlike other conduit repair systems, EPR Kits are capable of repairing various lengths and types of pipe quickly and accurately, saving you time and money.

ADVANTAGES

- 1 Restores structural integrity of conduit system
- 2 Cost savings with fast and easy installation
- 3 Compatibility – inside diameter of bell equals outside diameter of pipe to create a bell and spigot connection
- 4 Special interlocking joints provide water-tight seal
- 5 Packaging includes easy to follow instruction sheet
- 6 Ideal for the repair of rigid PVC conduit in electrical, telecommunication, utility and CATV applications



REPAIRS CONDUIT AS EASY AS 1-2-3

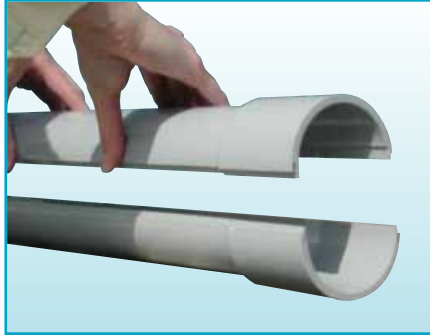
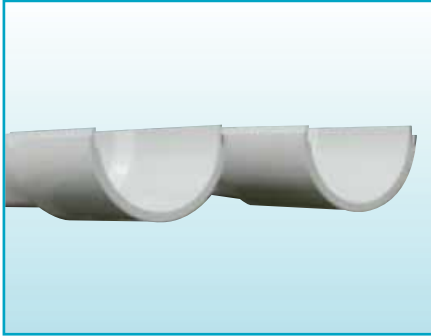

EPR KIT FOR CONDUIT REPAIR

Size (in)	Part Number	Product Code	Length (in)
1-1/4	EPR25	077976	24
1-1/2	EPR30	077971	24
2	EPR35	077972	24
2-1/2	EPR40	077973	24
3	EPR45	077974	24
4	EPR55	077975	24
5	EPR60	077977	24
6	EPR60	077979	24



SCEPTACON PVC FOR HDD

2" - 6" (75mm - 150mm)



SceptaCon™ is one of the first PVC systems designed for the rigors of trenchless applications. It links seamlessly to existing PVC conduit infrastructure and allows utilities to standardize on PVC throughout their entire electrical system.

And because SceptaCon is made to the same high standards as our Scepter Rigid PVC Conduit, contractors and electrical utilities can be assured of the same level of quality – above ground and below. SceptaCon delivers the performance, reliability and long life you expect from IPEX.

ADVANTAGES

1 No Cementing or Lubrication Required

SceptaCon's slide-in locking system and pre-installed, pre-lubricated gaskets allow contractors to create a water-tight seal by hand in seconds – in all temperatures without having to worry about solvents or chemicals freezing or drying too quickly.

2 No Fusion Required

Because SceptaCon joints can be quickly joined by hand in seconds, crews don't need large, expensive fusion equipment or special training to create water-tight joints.

In addition, SceptaCon can be assembled one pipe length at a time, then pulled underground, eliminating the need for long strings of pipe on the job. In this way, SceptaCon is ideal for short haul applications in cramped urban areas.

3 Superior Performance

SceptaCon is made from durable schedule 40 PVC that's resistant to creasing, scoring or flattening when pulled past obstructions in the borehole, yet flexible enough to bend with underground twists and turns. SceptaCon remains round, unlike HDPE which can stretch and become oval. And with PVC's proven 70-year history in underground piping, it's no surprise telecommunication contractors are turning to SceptaCon PVC raceway for reliable performance – now and over the long term.

4 Easier to Handle

SceptaCon saves crews all the hassles of working with HDPE. As any crew knows, cumbersome HDPE reels are heavy and awkward to transport and work with, and the material is notoriously rigid in cold temperatures. On the other hand, SceptaCon is available in convenient 10' and 20' lengths that are lightweight, easy to handle and no problem to work with in all types of weather.

APPLICATIONS

- Environmentally Sensitive Areas
- Historical Landmarks
- Road and Highway Crossings
- Urban Areas

STANDARDS



FAST AND EASY JOINT ASSEMBLY

SceptaCon needs no special equipment or training joining quickly to create a water-tight seal in seconds.



Step 1

Remove the red protective plugs and locking spline. Slide the spigot and bell ends past the pre-lubricated gasket to the positive stop alignment ring.



Step 2

Using the insertion hole, completely push the locking spline into the pipe's inner groove to lock lengths together.



Step 3

You're done! Our spline locking system ensures they'll stay together during pull-through and over their life underground.

SHORT FORM SPECIFICATIONS

GENERAL

Installation of conduit in defined areas (such as environmentally sensitive areas, existing roadways and high traffic pedestrian areas) shall be accomplished using trenchless horizontal directional drilling methods.

PRODUCT

The trenchless raceway system shall be manufactured of schedule 40 PVC and to PVC conduit specifications providing for a seamless transition to rigid nonmetallic conduit, duct or other approved conduit systems. Each length of conduit shall be supplied with end caps, a locking spline, a factory installed pre-lubricated o-ring seal and a positive stop alignment ring. Each length shall incorporate dimensionally precise machined grooves (internal on the bell and external on the spigot) whereby the connection of the raceway lengths creates a cavity for the locking spline. The bell end of each length shall have a label affixed by the manufacturer that provides installation instructions while clearly identifying and protecting the spline insertion opening.

Acceptable manufacturers are: SceptaCon Trenchless Raceway by IPEX.

APPROVALS

The Trenchless Raceway System shall be third party certified to UL651 and CSA C22.2 No.211.2.

PERFORMANCE SPECIFICATIONS

SceptaCon is made for fast installation, creating a water-tight seal in seconds with no special fusion equipment or training needed. SceptaCon is manufactured to UL651 and CSA C22.2 no. 211.2 standards and meets all testing requirements of Rigid PVC Conduit (PVC).

- SceptaCon's rated bend radius is sixty five (65) feet
- Rated Pulling Force
 - 2" – 3,000 lbs 4" – 8,700 lbs
 - 3" – 7,000 lbs 5" – 11,300 lbs 6" – 14,000 lbs
- SceptaCon's water tightness using the joint immersion test
 - 80psi pressure without a bending force applied
 - 80psi pressure when subjected to a 65 foot bend radius

SCEPTACON PRODUCT SELECTION CHART

Nominal Diameter		Product Code	O.D.		I.D.		Min. Wall	
in	mm		in	mm	in	mm	in	mm
2	53	(20') 106221	2.375	60.3	2.067	52.5	0.154	3.9
3	78	(10') 106330 (20') 106331	3.500	88.9	3.068	77.9	0.216	5.5
4	103	(10') 106340 (20') 106341	4.500	114.3	4.026	102.3	0.237	6.0
5	129	(10') 106350 (20') 106351	5.563	141.3	5.047	128.2	0.258	6.6
6	155	(10') 106360 (20') 106361	6.625	168.3	6.065	154.1	0.280	7.1

Every length is delivered with protective plugs to keep the conduit free of dirt and debris during shipping and job site handling.

THE SCEPTACON™ JOINT

Featuring slide-in spline locking system.

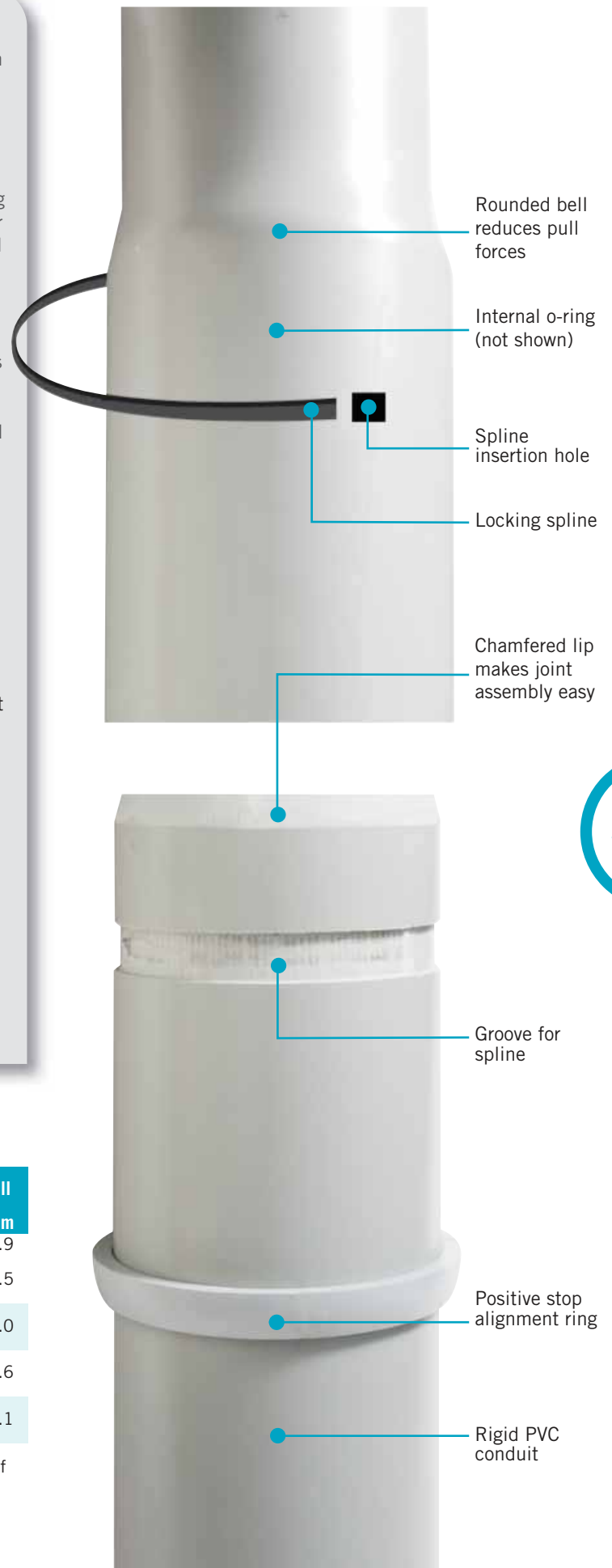

SUPER DUCT POWER & COMMUNICATIONS DUCT

2" - 6" (50mm - 150mm)

SUPER[®] DUCT

Super Duct is recognized by major utilities, contractors and engineering firms as the premier ducting product available on the market.

Super Duct is manufactured with a specialized compound, and engineered for high impact and crush strength specifically required by utilities for underground duct. This compound also enhances the friction coefficient of Super Duct for easier pulling of conductors/wires through long runs.

APPLICATIONS

- Utilities
- Telecom
- Hospitals / Medical Complexes
- Commercial Buildings
- Communications
- Cable

STANDARDS



1 Light Weight

Super Duct is easy to carry and install, reducing labour requirements and costs.

2 Long Lengths

Super Duct is available in 10' (3m) and 20' (6.1m) lengths, minimizing the number of connections needed.

3 Bell Ends

Super Duct is bell-ended, allowing for easy assembly in the field.

4 High Compressive Strength

Super Duct's specially formulated compound is designed to withstand high loads.

5 Low Coefficient of Friction

The smooth bore of Super Duct facilitates cable pulling and eliminates costly cable damage.

6 Quality Control

Stringent, continuous testing ensures that Super Duct is a consistently high quality product.

7 Field Bending

The natural flexibility of IPEX Super Duct allows field bending, to accommodate minor changes in elevation or direction.



SHORT FORM SPECIFICATIONS

PRODUCT

Duct shall be IPEX Super Duct or approved equal. Duct, fittings, spacers and solvent cement shall be provided by the same manufacturer to assure system integrity.

The duct is to be secured mechanically with vertical lock spacers to prevent disturbance to the alignment during installation.

INDENTIFICATION

Duct shall be identified for type and manufacturer and shall be traceable to plant location, date, shift and machine of manufacture. The markings shall be legible and permanent.

MATERIAL

Duct for use in underground, encased or direct burial applications shall be made from PVC compound that includes inert modifiers to give high modulus of elasticity, improved weatherability and deflection characteristics.

FIELD BENDING

Field bending can accommodate minor changes in elevation or direction without the use of special sweeps or fittings. The following table indicates typical maximum offset bends that can be achieved by cold bending.

ALLOWABLE OFFSET FOR SUPER DUCT

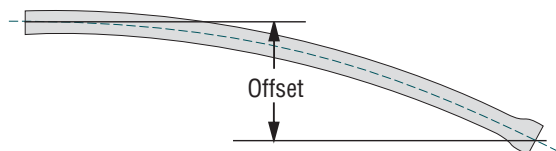

Size		Max Allowable Offset 10' Length		Max Allowable Offset 20' Length	
in.	mm	in.	mm	in.	mm
2	50	20	508	79	2 007
3	75	14	356	56	1 422
3-1/2	90	12	305	49	1 245
4	100	11	279	43	1 092
5	125	7	178	35	889
6	150	7	178	29	737

NOTES:

1. Axial deflection should not be attempted at the joints.
2. The above values were established for ambient temperatures above the freezing point. Increased radii may be desirable at below-freezing temperatures.



INSTALLATION

BENDS

Standard 90°, 45° and 22-1/2° bends are available from sizes 2" through to 6" in 24", 36", 42" and 60" radius. All bends are supplied with 6" (15.2cm) tangents. The centre line lay length (L) can be calculated using;

$$L = \left(\pi r \times \frac{\xi}{180} \right) + 2 (\text{tangent})$$

Where: π = 3.14

L = centre line lay length

r = radius of bend

ξ = angle of bend

tangent = 6"

Example: for a 3" 90° bend with a 36" radius - calculate the lay length:

$$L = \left(3.14 \times 36 \times \frac{90^\circ}{180^\circ} \right) + 2 (6)$$

$$L = 69 \text{ inches}$$

$$L(\text{metres}) = \frac{L \text{ imperial}}{12 \times 3.281} = \frac{69}{39.37} = 1.75\text{m}$$

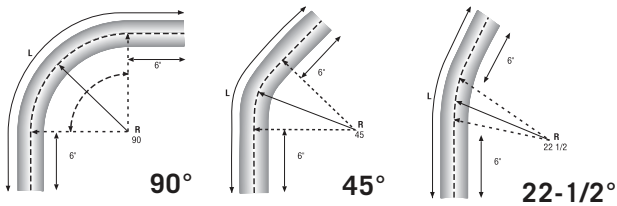

EXPANSION AND CONTRACTION

The following precautions should be exercised when extreme temperature variations are anticipated during the installation of IPEX Super Duct.

1. Allow extra duct footage at each tie-in for contraction when duct temperature is higher than soil temperature. Allow extra room for expansion if reverse condition exists.
2. Backfill from tie-in point toward end of duct run.

The coefficient of thermal expansion of IPEX Super Duct is 3×10^{-5} in./in./°F (5.4×10^{-5} mm/mm/°C). These charts show the expansion that can be expected at various temperature ranges for unburied (unrestrained) duct.

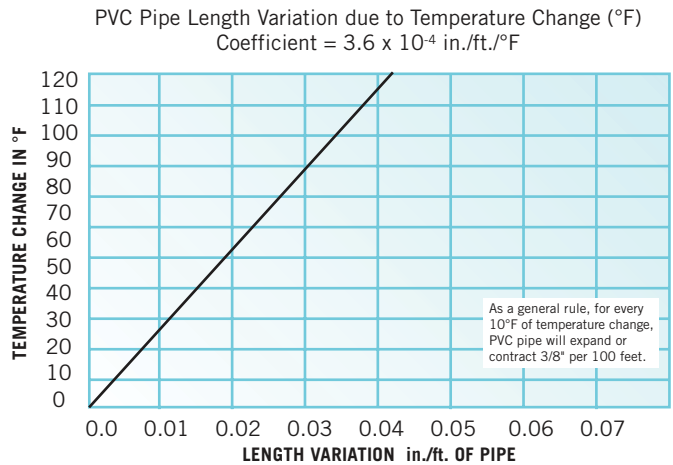

STATIC FRICTION COEFFICIENT

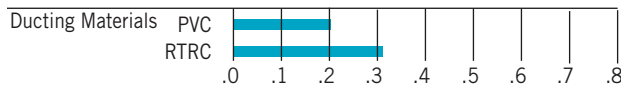

SUPER DUCT DIMENSIONS

Dimension in	Minimum ID in	Nominal Wall in	Average OD in
2	2.001	.082	2.250
3	3.000	.097	3.250
3-1/2	3.480	.109	3.730
4	3.941	.120	4.216
5	4.974	.153	5.299
6	5.896	.180	6.275

TELEPHONE DUCT

Type B, Type B(HW), Type C, Type D

Telephone Duct Type B and Type B – Heavy Wall are designed for use in concrete-encased installations.

Telephone Duct Type C is designed for direct burial applications.

Telephone Duct Type D is designed for exposed and special applications, and contains 6% titanium oxide for UV resistance.

Nominal Size	Product Code	Type	Avg OD	Min Wall	Min ID
--------------	--------------	------	--------	----------	--------

PVC Telephone Duct - 20 foot Length, Belled One End

4	008040	B	4.350	0.091	4.13
4	008041	B (HW)	4.350	0.101	4.11
4	008042	C	4.350	0.148	4.00
4	008043	C X 10'	4.350	0.148	4.00
4	008044	D	4.350	0.148	4.00

Type	Minimum Impact Resistance		Minimum Pipe Stiffness lbs/in/in	Heat Distortion 48 hrs @ 140°F	
	@ 73.4°F	@ 32°F		Load	Max decr.

Performance Properties

As indicated under Telephone Standard 8546

B	50 ft.lbs.	25 ft.lbs.	30	15	0.250"
B(HW)	50 ft.lbs.	25 ft.lbs.	40	15	0.250"
C	100 ft.lbs.	50 ft.lbs.	120	60	0.250"
D	150 ft.lbs.	75 ft.lbs.	120	60	0.250"

POWER AND COMMUNICATION DUCT

Rated for 90° cable

NEMA TC – 6 and 8, ASTM D1784 and ASTM F512

ENCASED BURIAL

Nominal Size	Product Code	Avg OD	Min Wall	ft/Pallet	Approx Wt/lbs
--------------	--------------	--------	----------	-----------	---------------

Type EB-20

Rated For 90°C Cable / 20-Foot Length, Belled One End

2	008821	2.375	0.060	3,520	37
3	008831	3.500	0.061	1,560	56
*4	008841	4.500	0.082	1,200	93
*5	008851	5.563	0.103	460	142
*6	008861	6.625	0.125	520	202

* UL Listed

Type EB-35

Rated For 90°C Cable / 20-Foot Length, Belled One End

2	008921	2.375	0.060	3,520	33
3	008931	3.500	0.076	1,560	64
4	008941	4.500	0.100	1,200	105
5	008951	5.563	0.126	460	161
6	008961	6.625	0.152	520	230

DIRECT BURIAL

Nominal Size	Product Code	Avg OD	Min Wall	ft/Pallet	Approx Wt/lbs
--------------	--------------	--------	----------	-----------	---------------

Type DB-60

Rated For 90°C Cable / 20-Foot Length, Belled One End

2	008321	2.375	0.060	3,520	37
3	008731	3.500	0.092	1,560	80
4	008741	4.500	0.121	1,200	132
5	008751	5.563	0.152	460	202
6	008761	6.625	0.182	520	285

Type DB-120

Rated For 90°C Cable / 20-Foot Length, Belled One End

2	008621	2.375	0.077	3,520	42
3	008631	3.500	0.118	1,560	96
4	008641	4.500	0.154	1,200	158
5	008651	5.563	0.191	460	240
6	008661	6.625	0.227	520	336

CONDUIT ELBOWS

Size inches	Degree Bend	18" Radius Product Code	24" Radius Product Code	36" Radius Product Code	48" Radius Product Code	150" Radius Product Code
2	90	029057	029321	029351	029401	#
	45	029124	029326	029356	029408	#
	30	029280	029331	029361	029415	#
	22-1/2	029286	029336	029366	029422	#
	11-1/4	029296	029346	029381	029429	#
3	90	029058	029322	029352	029402	#
	45	029125	029327	029357	029409	#
	30	029281	029332	029362	029416	#
	22-1/2	#	029337	029367	029423	#
	11-1/4	029297	029347	029382	029430	#
4	90	029059	029323	029353	029403	#
	45	029126	029328	029358	029410	#
	30	029282	029333	029363	029417	#
	22-1/2	029287	029338	029368	029424	#
	11-1/4	029298	029348	029383	029431	#
5	90	#	029324	029354	029404	029445
	45	#	029329	029359	029411	029460
	30	#	029334	029364	029418	029467
	22-1/2	#	029339	029369	029425	029511
	11-1/4	#	029349	029384	029432	029527
6	90	#	#	029355	029405	029446
	45	#	#	029360	029412	029461
	30	#	#	029365	029419	029468
	22-1/2	#	#	029374	029426	029512
	11-1/4	#	#	029385	029433	029528

Bookmark Our Website

www.ipexamerica.com



**PRODUCT INFO,
TECHNICAL
DOCUMENTS,
ONLINE TRAINING
& MUCH MORE ...**



**OUR SCEPTER ELECTRICAL CATALOGUE & ELECTRICAL
POCKET PRO INCLUDE MORE INFORMATION ON:**

- Conduit & Fittings
- Light Fixtures
- ENT Tubing & Fittings
- Duct
- Trenchless Raceways
- and much more ...

available at www.ipexamerica.com

CUSTOMER SERVICE CENTER

IPEX USA LLC

2441 Royal Windsor Drive
Mississauga, Ontario L5J 4C7
Phone: (905) 403-0264
Toll Free: (800) 463-9572
Fax: (905) 403-9195

www.ipexamerica.com

About the IPEX Group of Companies

As leading suppliers of thermoplastic piping systems, the IPEX Group of Companies provides our customers with some of the world's largest and most comprehensive product lines. All IPEX products are backed by more than 50 years of experience. With state-of-the-art manufacturing facilities and distribution centers across North America, we have established a reputation for product innovation, quality, end-user focus and performance.

Markets served by IPEX group products are:

- Electrical systems
- PVC, CPVC, PP, ABS, PEX, FR-PVDF and PE pipe and fittings (1/4" to 48")
- Industrial process piping systems
- Municipal pressure and gravity piping systems
- Plumbing and mechanical piping systems
- PE Electrofusion systems for gas and water
- Industrial, plumbing and electrical cements
- Irrigation systems

Products are manufactured by IPEX Electrical Inc. and distributed in the United States by IPEX USA LLC.

Kwikflex®, Kwikon®, SceptaCon™, Sceptalight™ and Super Duct® are trademarks of IPEX Branding Inc.

This literature is published in good faith and is believed to be reliable. However, it does not represent and/or warrant in any manner the information and suggestions contained in this brochure. Data presented is the result of laboratory tests and field experience.

A policy of ongoing product improvement is maintained. This may result in modifications of features and/or specifications without notice.



CTELNAIP130707 © 2013 IPEX